

June 2014



**Commercial
Vehicles**

Amarok



TAKE THE ROUGH WITH THE SMOOTH.

When other vehicles reach their limits, the **Amarok** exceeds. It performs as effortlessly on rough terrain as it does on the open road – offering levels of quality and style like no other pickup. At the heart of every Amarok sits a powerful diesel engine, which when coupled to a robust ladder frame chassis, 4MOTION and heavy-duty suspension, is a combination that ensures swift and stable progress and enables the Amarok to tow trailer weights of up to 3,200kg. Inside, there's ergonomic seats and numerous storage trays, allowing up to five occupants and their kit or luggage to be accommodated with ease. As you'd expect from any Volkswagen, the Amarok is loaded with safety features, all designed to help ensure you, your passengers and your cargo arrive in perfect condition – whatever the terrain.



- 04 Safety systems
- 06 Engines and gearboxes
- 07 BlueMotion Technology
- 08 4MOTION
- 10 Comfort and flexibility
- 12 Amarok Startline
- 14 Amarok Trendline
- 16 Amarok Highline
- 19 Standard equipment
- 20 Paint finishes
- 21 Upholstery
- 22 Alloy wheels
- 23 Audio and communications
- 24 Engine, gearbox, economy and performance data
- 25 Dimensions and weights
- 26 Accessories
- 34 Service and warranties

YOUR SAFETY IS OUR PRIORITY.

Your safety is a vital factor, so we ensure that a long list of safety and security features are built-in to every vehicle we produce. Almost every part of the vehicle's design contributes to safety. Occupants are securely enclosed within a rigid safety cell with crumple zones to absorb crash energy, while the chassis and suspension are designed for excellent directional stability and handling. Features such as Anti-lock Braking System (ABS), Electronic Brakeforce Distribution (EBD/EBV), Electronic Stabilisation Programme (ESP), Hill Hold Assist, Hill Descent Control and driver and passenger front, side and curtain airbags are fitted as standard. When you need maximum grip, our Selectable and Permanent 4MOTION all-wheel drive systems help to maintain traction in poor driving conditions or when driving off-road. For extra security and protection, the Amarok features an anti-theft alarm system and a three-seat rear bench with two ISOFIX child seat mountings as standard – both offering additional peace-of-mind.



- 01** When the vehicle weight is transferred to the front wheels during braking, the **Electronic Brakeforce Distribution (EBD/EBV)** prevents lockup of the rear wheels, which are under less load. This helps your vehicle brake safely in a straight line.
- 02** The **seatbelt warning** reminds the driver that their seatbelt is not fastened. An audiovisual signal is used to request that the seatbelt is fastened before you start driving.
- 03** The **Electronic Stabilisation Programme (ESP)** prevents the vehicle from skidding in critical driving conditions by controlled and targeted intervention in the brake and engine management. Thus, the vehicle achieves maximum directional stability.
- 04** **Hill Descent Control** automatically operates at speeds below 18mph when the vehicle's Off-road ABS is being used. It controls the braking to prevent unintentional acceleration on extreme descents.
- 05** The **Anti-lock Braking System (ABS)** prevents wheels from locking up and therefore significantly improves the manoeuvrability of the vehicle under heavy braking.
- 06** The **Brake Assist** system recognises the speed at which the brake pedal is actuated. In the case of reflex or emergency braking, the system applies full brake pressure more rapidly to achieve the shortest possible stopping distance.



Driver and front passenger **airbags** (with front passenger deactivation switch) are fitted as standard to all Amarok models. Likewise, side and curtain airbags are also standard across the range.



In addition to its standard Anti-lock Braking System (ABS), the Amarok is equipped with **Off-road ABS** for use when driving off-road. When activated, it regulates braking to help retain control on rough terrain.



Integrated into the front fog lights, optional **Cornering lights** help to illuminate curves and bends in the road ahead. This allows you to anticipate possible risks sooner, helping you to arrive at your destination safely.

Main image features optional equipment.

STEADY PROGRESS.

Our renowned TDI engines have long been setting the standards in diesel technology – and with rising fuel costs, we've also been working hard to lower fuel consumption, while reducing CO₂ emissions. The Amarok range reflects this with a choice of two powerful 2.0 litre common-rail diesel engines, both complying with Euro 5 emission limits and equipped with diesel particulate filters as standard. While the 140PS diesel engine uses TDI technology, the 180PS diesel engine features BiTurbo (BiTDI) technology for the ultimate diesel experience. Above all, you'll discover that whichever engine or gearbox you choose, or terrain you encounter, the Amarok will carry you to your destination swiftly and safely.

2.0 LITRE 103kW (140PS) TDI ENGINE.¹

Thanks to a remarkable 340Nm maximum torque, the 140PS TDI diesel engine is a pleasure to drive. CO₂ emissions and fuel consumption have been significantly reduced for the sake of the environment and your pocket. Available with a 6-speed manual gearbox and Selectable 4MOTION as standard.

2.0 LITRE 132kW (180PS) BiTDI ENGINE.¹

As the most powerful engine in the range, the amazing 180PS BiTDI diesel engine uses BiTurbo (BiTDI) technology and produces 400Nm maximum torque when mated to a 6-speed manual gearbox with Selectable 4MOTION, or an incredible 420Nm maximum torque when mated to the Highline's 8-speed automatic gearbox with Permanent 4MOTION.



8-SPEED AUTOMATIC GEARBOX.

Uniquely available on the Highline 180PS BiTDI is our slick 8-speed automatic gearbox. While the first gear is optimised for off-road use and pulling-away when towing, the eighth gear is designed as an overdrive to reduce revs, maximise fuel-efficiency and give relaxed cruising at motorway speeds.



BLUEMOTION TECHNOLOGY.

BlueMotion Technology (BMT) is available on the 180PS BiTDI 8-speed automatic Amarok Highline. It consists of four key elements, namely **cruise control**, **low rolling resistance tyres**, **regenerative braking** and **Start/Stop**, which when added together, contribute to significant improvements in fuel consumption and CO₂ emissions. This not only benefits your pocket, but also the environment.

FOUR KEY ELEMENTS.

1. CRUISE CONTROL.

By driving at a constant speed, cruise control saves fuel which would normally be wasted by fluctuations in speed. This lowers CO₂ emissions with the benefit of increasing driver comfort.

2. LOW ROLLING RESISTANCE TYRES.

These don't need to work as hard to get your Amarok moving (and keep it rolling) which is especially useful when travelling fully loaded. This reduces engine work, saves fuel and lowers CO₂ emissions.

3. REGENERATIVE BRAKING.

When you brake, the energy recuperation system uses momentum to turn the alternator and charge the battery. A well charged battery results in the engine doing less work, which in-turn saves fuel and lowers CO₂ emissions.

4. START/STOP.

Allows you to save fuel by automatically turning the engine off when you stop and engage neutral. As soon as it's time to move, the engine starts up again. A simple, but highly effective system.

¹ Please refer to page 24 for information about fuel consumption and CO₂ emissions.

4MOTION. READY FOR THE CHALLENGE.

4MOTION

The Amarok's innovative **Selectable and Permanent 4MOTION** all-wheel drive systems enable sure-footed progress when you encounter rain, snow, sand, mud or gravel. They're designed to maintain traction while off-road, as well as offering improved road holding and increased safety in poor surface conditions. And for added safety, 4MOTION is compatible with Anti-lock Braking System (ABS), Electronic Brakeforce Distribution (EBD/EBV), Electronic Stabilisation Programme (ESP) and Off-road ABS. Perfect for getting you to places that other vehicles can't reach, 4MOTION will transport you on an adventure that doesn't end just because the road does.



4MOTION EXPLAINED.

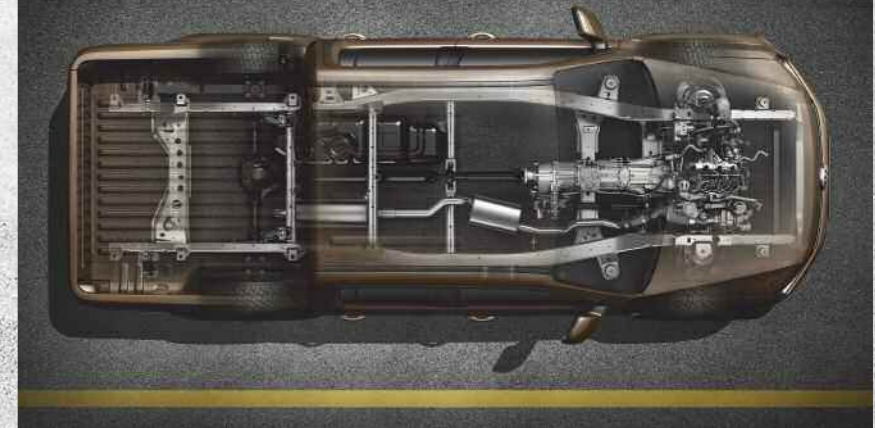

SELECTABLE 4MOTION.

Allows you to switch between high and low gear ranges and rear or all-wheel drive. In all-wheel drive mode, power is distributed evenly between the front and rear axles to ensure the best possible traction.

PERMANENT 4MOTION.

Standard on the 180PS BiTDI 8-speed automatic Highline, all-wheel drive is engaged whether you're on or off-road. In normal circumstances, the Torsen differential distributes power 40:60 between the front and rear wheels, but when off-road, the system automatically distributes power to the wheels with the most grip. When combined with other systems such as Hill Start and Hill Descent Control, you'll find the Amarok virtually unstoppable.

WADING DEPTH AND APPROACH/DEPARTURE ANGLES.

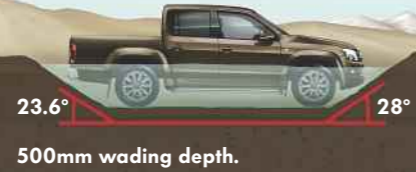

RAMP ANGLE.¹



HILL CLIMBING ABILITY.¹



SIDE SLOPE ANGLE.^{1,2}



¹ With 1 tonne payload, figures may vary depending on the trimline and engine type.

² The side slope angle on the near-side is 49.7° and 50.8° on the off-side.



THE BEST OF BOTH WORLDS.

The Amarok is designed to set new standards. It's luxurious, stylish and highly specified, yet robust enough to take day-to-day use – whether loaded with crew and their tools or kit, or a family of five with bikes or camping equipment. It's a vehicle that's designed to make a statement too, with rugged good-looks, go-anywhere all-wheel drive and a purposeful stance that's complimented with powerful engines, refinement, economy and reliability – leading to high residual values and low whole-life costs.

Once seated inside, you'll find the Amarok's ergonomic layout and dynamic driving characteristics are supported by an extensive specification. Even the rugged Startline features refinements such as driver and passenger front, side and curtain airbags, an RCD 210 radio with MP3 compatible CD player and AUX-IN socket, Climatic air conditioning, electric front and rear windows, electrically heated and adjustable door mirrors and remote central locking. The Amarok ergonomic front seating is no less impressive. Driver and passenger 3-point seatbelts are adjustable for height and include tensioners as standard. At the rear, there's masses of space across the split/folding three-seat bench, which includes two ISOFIX child seat mountings to the outer seats. However you plan to use your Amarok, you'll find it the perfect vehicle when you want to combine luxury and space with the ability to shift heavy loads over any terrain.

FLEXIBILITY THAT WORKS.

When it comes to carrying your load, you'll find the Amarok more than capable. With 1,222mm between the wheel arches, a maximum load length of 1,555mm, load width of 1,620mm, load height of 508mm (when covered), not to mention four handy load-lashing rings and a large tailboard capable of supporting 250kg, the Amarok's load area easily accommodates a Euro pallet between the wheel arches and transports payloads up to 1,112kg.

And with the option to enhance and protect your Amarok's load area with a range of **Add Ons** – including load covers, load liners, styling bars and hardtops, your Amarok is guaranteed to be as stylish as it is functional. To discover more about **Add Ons**, take a look at **page 26**.

AMAROK STARTLINE.

If getting the job done is important to you, then the **Amarok Startline** is the natural choice. It's a rugged performer with heavy-duty suspension and a mechanical differential lock (unique to Startline), to make sure you're never stuck for grip. Quality wipe-clean surfaces and a tough rubber floor covering (carpet available at no extra cost), make it ideal for commercial users who need a robust pickup that's well-built and designed to take the roughest treatment. And when it comes to practicality, the Startline scores highly too, with an interior trimmed in durable Austin upholstery and featuring numerous storage areas, such as large compartments in the doors. But it's not just about being rough and ready – the Startline retains the same levels of style, safety features and driving characteristics that you'd expect from any Amarok.



04



05



06

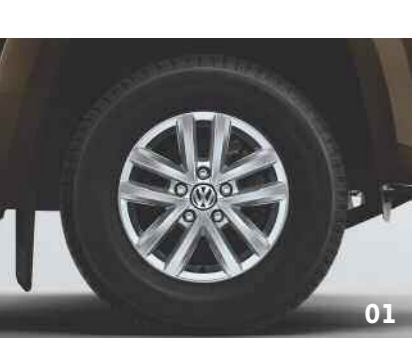

01

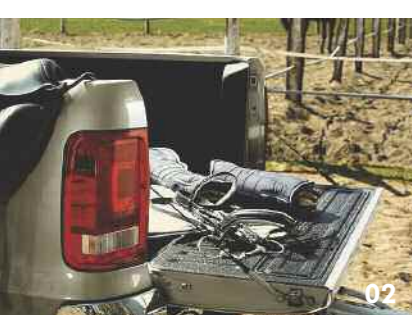

02



03



- 01 16" Korama alloy wheels with 245/70 R16 tyres.
- 02 Large tailboard capable of supporting 250kg.
- 03 Large front and rear mudflaps reduce spray and help to prevent damage to bodywork from flying stones.

- 04 Three-seat split/folding rear bench with ISOFIX child seat mountings to outer seats.
- 05 Climatic semi-automatic air conditioning helps create a relaxed and comfortable environment.
- 06 RCD 210 radio with single MP3 compatible CD player, AUX-IN socket and two speakers.

AMAROK TRENDLINE.

The **Amarok Trendline** builds on the Startline's strengths by adding a host of stylish, practical and comfort-based features – all designed to enhance your experience of ownership and create a pickup with levels of luxury to rival any vehicle. Take style for instance, where the Trendline's exterior receives chrome detailing to the upper front grille, body-coloured door handles, mirrors and extended wheel arches, front fog lights and attractive 17" Aldo alloy wheels. The interior is no less impressive, with further chrome and silver detailing, an armrest in the centre console, under-seat storage, carpet floor coverings and luxurious Trail upholstery setting the scene. Add to this a quality RCD 310 radio with MP3 compatible CD player, AUX-IN socket and six speakers, Climatronic 2-zone automatic air conditioning, cruise control, trip computer with multi-function display and a leather steering wheel, gearknob, gaiter and handbrake handle and you'll discover the Trendline's qualities are more than skin deep. Choose a Trendline and you'll have a pickup that's ideal for businesses who want to make an impression, or for families that like to get out-and-about, but don't want to compromise on comfort, space and style.

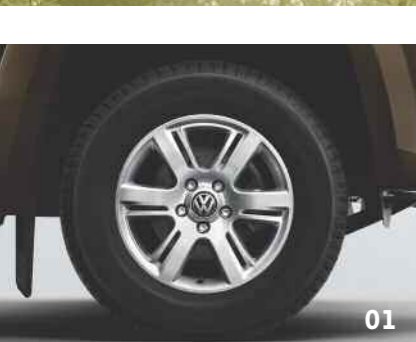

Main image features optional equipment.

- 01 17" Aldo alloy wheels with 245/65 R17 tyres.
- 02 Body-coloured front bumper with fog lights and chrome detailing to upper grille.
- 03 Body-coloured door mirrors and handles.
- 04 Leather steering wheel, gearknob, gaiter and handbrake handle.

- 05 Trip computer with multi-function display and chrome detailing in instrument cluster.
- 06 Cruise control maintains a constant speed at the touch of a button.
- 07 Climatronic 2-zone automatic air conditioning.
- 08 RCD 310 radio with single MP3 compatible CD player, AUX-IN socket and six speakers.

AMAROK HIGHLINE.

With a specification to grace any top-of-the-range vehicle, the **Amarok Highline** offers unprecedented levels of luxury. Before you step inside, you'll notice an imposing exterior that features striking 18" Durban alloy wheels, privacy glass, chrome/body-coloured door mirrors, polished stainless steel side bars and a chrome rear bumper with integrated step. Once inside, the quality of the Highline becomes even more evident, with sumptuous Vienna leather upholstery, heated driver and front passenger seats, an upgraded dashboard with chrome detailing to air vents and light switches and finally, an extensive multi-function plus pack – including analogue fuel gauge and engine coolant temperature displays, navigation display (where fitted) and mobile phone preparation. And with a choice of a 6-speed manual with Selectable 4MOTION, or 8-speed automatic with Permanent 4MOTION and standard BlueMotion Technology, the Highline is guaranteed to add to the sense of occasion.

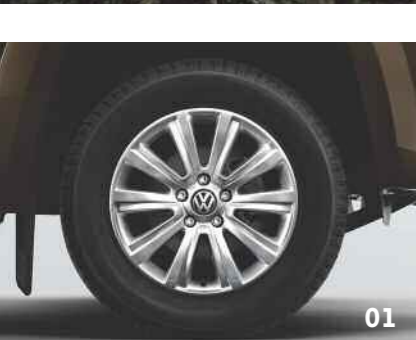

- 01 18" Durban alloy wheels with 255/60 R18 tyres.
- 02 Body-coloured front bumper with chrome detailing to upper and lower grille.
- 03 Polished stainless steel side bars.

- 04 Optional RNS 510 satellite navigation with colour touch-screen, 30GB hard drive, single CD/DVD drive, AUX-IN and SD card slot.
- 05 Start/Stop – standard on 180PS, 8-speed automatic BlueMotion Technology.
- 06 Vienna leather upholstery for front and rear seats.

Main image features optional equipment.



STARTLINE STANDARD EQUIPMENT.

AUDIO AND COMMUNICATIONS.

RCD 210 radio with single MP3 compatible CD player, AUX-IN socket and two speakers.

INTERIOR.

Climatic semi-automatic air conditioning.
Electric front and rear windows.
Grab handle on passenger side 'A' pillar.
Rubber floor covering in cab.
Austin cloth upholstery.
Three-seat folding rear bench with ISOFIX child seat mountings to outer seats.
12v socket in centre console.

EXTERIOR.

Black rear bumper with integrated step.
Black door mirrors and handles.
Body-coloured front bumper.

Easy-to-use lockable tailgate.

Electrically heated and adjustable door mirrors.

Load compartment light.

Mudflaps to front and rear.

Towbar preparation.

SAFETY AND SECURITY.

Airbags – driver and front passenger (with passenger deactivation), front side and curtain head protection.

Anti-lock Braking System (ABS) with Off-road ABS.

Anti-Slip Regulation (ASR).

Electronic Differential Lock (EDL).

Electronic Stabilisation Programme (ESP).

Four load-lashing rings in load area.

Heavy-duty suspension.

Hill Start and Hill Decent Control.

Mechanical rear differential lock (Startline only).

Remote central locking with deadlocks, interior locking and two remote keys.

Thatcham Category 1 approved immobiliser and alarm.

Trailer stabilisation.

Selectable 4MOTION transmission.

WHEELS AND TYRES.

WHEELS

16" x 6.5J Korama alloy wheels.

TYRES

245/70 R16 tyres.

Full size steel spare wheel.

Locking wheel bolts.

Tool kit and jack.

TRENDLINE EQUIPMENT IN ADDITION TO STARTLINE.

AUDIO AND COMMUNICATIONS.

RCD 310 radio with single MP3 compatible CD player, AUX-IN socket and six speakers.

Trip computer with multi-function display and chrome detailing in instrument cluster.

12v sockets x 3 – located in dashboard, centre console and load compartment.

INTERIOR.

Armrest in centre console.

Carpet floor covering in cab.

Climatronic 2-zone automatic air conditioning.

Cruise control.

Grab handle on passenger side 'A' and 'B' pillars.

Leather steering wheel, gearknob, gaiter and handbrake handle.

Silver inlay around gearlever console.

Trail cloth upholstery.

Under-seat storage compartment below driver and front passenger seats.

EXTERIOR.

Body-coloured door mirrors, handles and wheel arch extensions.

Chrome detailing in upper front grille.

Front fog lights.

WHEELS AND TYRES.

WHEELS

17" x 8J Aldo alloy wheels.

TYRES

245/65 R17 tyres.

HIGHLINE EQUIPMENT IN ADDITION TO TRENDLINE.

AUDIO AND COMMUNICATIONS.

Multi-function plus pack – analogue fuel gauge, engine coolant temperature display, navigation display (where fitted) and mobile phone preparation.

INTERIOR.

Dashboard upgrade – air vents with chrome ring inserts and light switch with chrome surround.

Dimmable dashboard illumination.

Heated driver and front passenger seats.

Vienna leather upholstery (seat material in contact with driver and passengers is leather, other areas are leatherette).

EXTERIOR.

Chrome detailing in upper and lower front grille.

Chrome/body-coloured door mirrors.

Chrome rear bumper with integrated step.

Front and rear parking sensors.

Polished stainless steel side bars.

Rear privacy glass.

WHEELS AND TYRES.

WHEELS

18" x 7.5J Durban alloy wheels.

TYRES

255/60 R18 tyres.

PAINT FINISHES.



CANDY WHITE
Solid paint
B4B4



ONTARIO GREEN
Solid paint
V7V7



REFLEX SILVER
Metallic paint¹
8E8E



NATURAL GREY
Metallic paint¹
M4M4



STARLIGHT BLUE
Metallic paint¹
3S3S



SAND BEIGE
Metallic paint¹
P8P8



TOFFEE BROWN
Metallic paint¹
4Q4Q



DEEP BLACK
Pearl effect paint¹
2T2T

UPHOLSTERY.

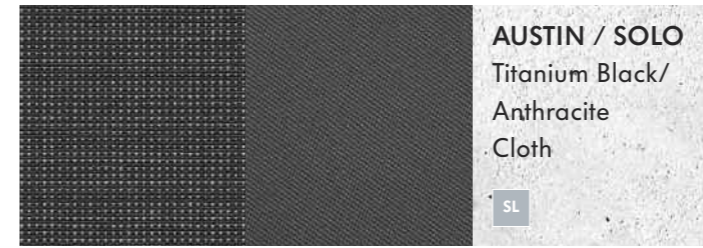

AUSTIN / SOLO
Titanium Black/
Anthracite
Cloth

SL

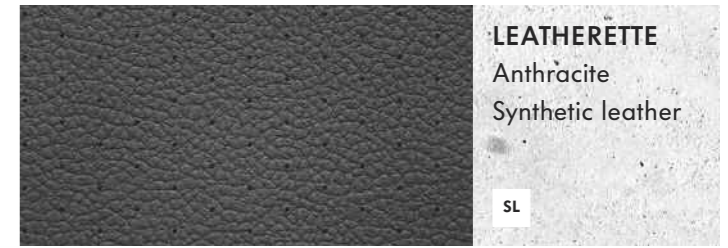

LEATHERETTE
Anthracite
Synthetic leather

SL



TRAIL / SOLO
Anthracite
Cloth

TL

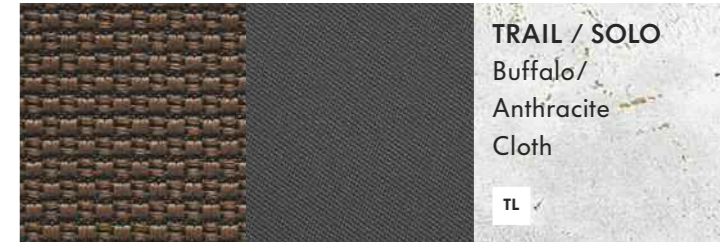

TRAIL / SOLO
Buffalo/
Anthracite
Cloth

TL



**VIENNA
LEATHER²**
Anthracite

HL

TL



**VIENNA
LEATHER²**
Mendoza

HL



ALCANTARA[®]
Anthracite
Alcantara[®] /
Leatherette

TL

HL

KEY.

STANDARD

OPTIONAL

SL STARTLINE

TL TRENDLINE

HL HIGHLINE

¹ Metallic and pearl effect finishes are available at extra cost.

² Seat material in contact with driver and passengers is leather, all other areas are leatherette.

Please note: Not all paint and upholstery combinations can be ordered together and in some instances certain combinations may incur extra cost.

Print processes do not allow exact reproduction of paint colours.



ALLOY WHEELS.



16" KORAMA
6.5J x 16 alloys with
245/70 R16 tyres.
Standard on Startline.



17" ALDO
8J x 17 alloys with
245/65 R17 tyres.
Standard on Trendline.



17" ROÇA
8J x 17 alloys with
245/65 R17 tyres.



18" DURBAN
7.5J x 18 alloys with
255/60 R18 tyres.
Standard on Highline.



19" ALASTARO
8J x 19 alloys with
255/55 R19 tyres.



19" CANTERA
8J x 19 alloys with
255/55 R19 tyres.

AUDIO AND COMMUNICATIONS.



RCD 210
FM/AM radio.
Single CD player.
MP3-file compatible.
AUX-IN socket.
2 speakers.



RCD 310
FM/AM radio.
Single CD player.
MP3-file compatible.
AUX-IN socket.
6 speakers.



RNS 315
5" colour touch-screen.
6GB flash memory.
FM/AM radio with RDS.
Single CD player.
AUX-IN and SD card slot.
Western European data.
6 speakers.



RNS 510
6.5" colour touch-screen.
30GB hard drive.
FM/AM radio with RDS.
Single CD/DVD drive.
AUX-IN and SD card slot.
Western European data.
6 speakers.

Please note: For alloy wheel, audio and communications compatibility and fitment, please see separate price list.

ENGINE AND GEARBOX DATA.

ENGINE SPECIFICATIONS.	2.0TDI 140PS	2.0BiTDI 180PS	2.0BiTDI 180PS AUTOMATIC
Engine type	Diesel, water-cooled, in-line, variable turbine geometry turbocharger with intercooler	Diesel, water-cooled, in-line, bi-turbo with intercooler	
Mixture preparation/injection method	Common-rail, direct injection		
EU exhaust emission standard	EURO 5		
Number of cylinders	4		
Cubic capacity	1,968cc		
Output, PS at rpm	140 at 3,750	180 at 4,000	180 at 4,000
Torque, max. Nm at rpm	340 at 1,750-2,250	400 at 1,500-2,000	420 at 1,750
Diesel Particulate Filter (DPF)	●	●	●
6-speed manual gearbox	●	●	-
8-speed automatic gearbox	-	-	●
Selectable 4MOTION	●	●	-
Permanent 4MOTION	-	-	●
BlueMotion Technology	-	-	●

- Standard
- Not available

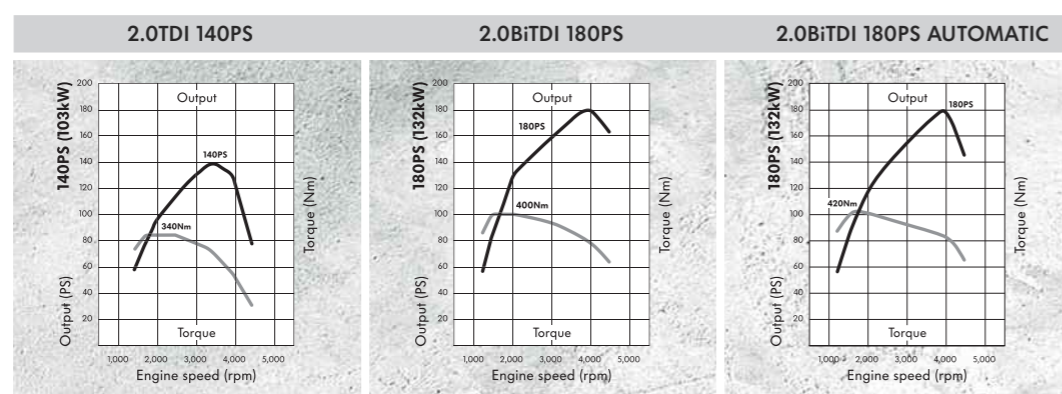

AMAROK DIMENSIONS AND WEIGHTS.

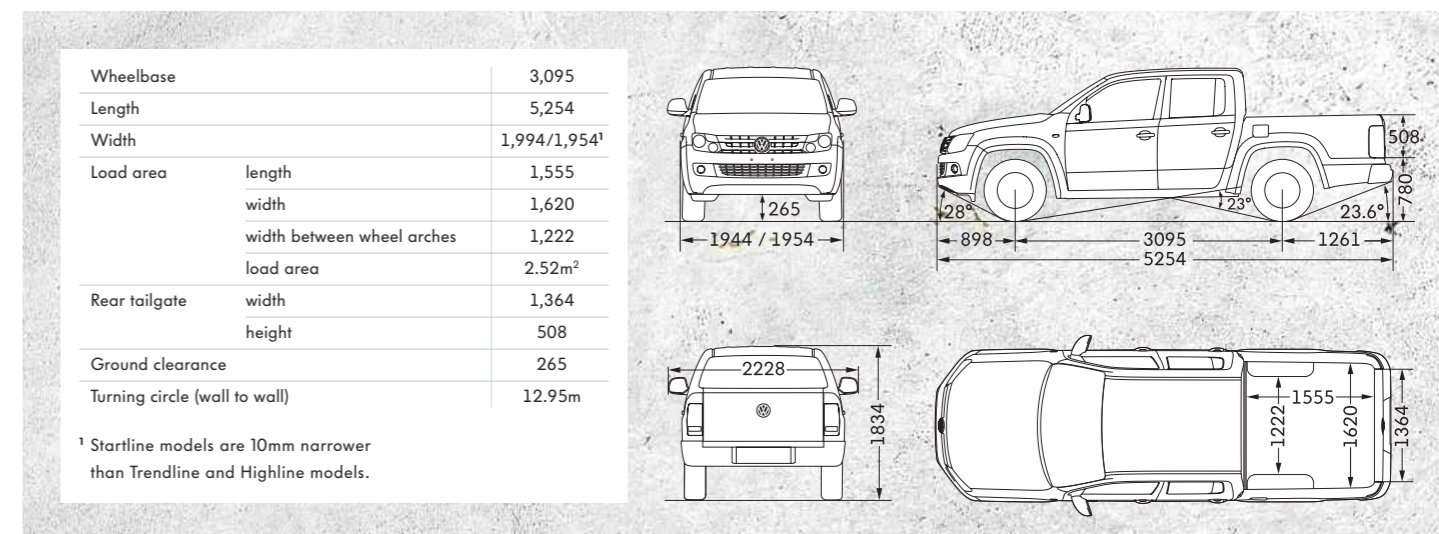

Engine/transmission	Gross vehicle weight kg	Axle load limit front/rear kg	Trailer weight braked 12%/unbraked kg	Gross train weight kg	Unladen weight ² kg	Payload ³ kg
AMAROK STARTLINE.						
2.0TDI 140PS Selectable 4MOTION	3,170	1,375 / 1,620	3,000 / 750	5,550	2,108	1,062
AMAROK TRENDLINE.						
2.0TDI 140PS Selectable 4MOTION	3,170	1,375 / 1,620	3,000 / 750	5,550	2,113	1,057
2.0BiTDI 180PS Selectable 4MOTION	3,170	1,410 / 1,860	3,000 / 750	5,550	2,058	1,112
AMAROK HIGHLINE.						
2.0BiTDI 180PS Selectable 4MOTION	3,170	1,410 / 1,860	3,000 / 750	5,550	2,079	1,091
2.0BiTDI 180PS Automatic Permanent 4MOTION BMT	3,170	1,425 / 1,860	3,200 / 750	5,950	2,093	1,077

FUEL CONSUMPTION, PERFORMANCE AND EMISSIONS.

Engine/transmission	Urban mpg (ltr/100km) ¹	Extra-urban mpg (ltr/100km) ¹	Combined mpg (ltr/100km) ¹	Acceleration 0-62 mph seconds	Top speed (where law permits) mph	CO ₂ emissions g/km ¹
AMAROK STARTLINE.						
2.0TDI 140PS Selectable 4MOTION	29.4 (9.6)	41.5 (6.8)	36.2 (7.8)	13.5	101	205
AMAROK TRENDLINE.						
2.0TDI 140PS Selectable 4MOTION	29.4 (9.6)	41.5 (6.8)	36.2 (7.8)	13.5	101	205
2.0BiTDI 180PS Selectable 4MOTION	30.7 (9.2)	38.7 (7.3)	35.3 (8.0)	11.0	111	211
AMAROK HIGHLINE.						
2.0BiTDI 180PS Selectable 4MOTION	30.7 (9.2)	38.7 (7.3)	35.3 (8.0)	11.0	111	211
2.0BiTDI 180PS Automatic Permanent 4MOTION BMT	31.0 (9.1)	38.2 (7.4)	35.3 (8.0)	11.3	108	211

¹ The fuel consumption and emission values listed here have been ascertained in accordance with the legally stipulated measuring method. These figures do not refer to a particular specific vehicle and do not constitute part of the offer but are purely for comparison purposes between the various types of vehicle. In addition to the fuel efficiency of a vehicle, driving behaviour as well as other non-technical factors (such as environmental conditions) play a role in determining a vehicle's fuel consumption and CO₂ emissions. In addition to weather and traffic conditions, extra equipment and accessories (attachment parts, tyres, etc.) may change vehicle parameters such as the weight, rolling resistance of the tyres and the aerodynamics and thus influence the fuel consumption and driving performance values.

² Unladen weight figures are calculated with 100% fuel load and no driver.

³ Payload = gross vehicle weight - unladen weight. Weights are for vehicles with standard specification.

The addition of factory options or Volkswagen Van Centre fitted accessories may affect unladen weight and payload.

Please note: Vehicle drawings are not to scale. All dimensions in millimeters (mm), unless otherwise stated.

The height measurements listed may vary by ± 50mm depending on model and equipment fitted.

Add Ons

Accessories to help keep your vehicle 100% Volkswagen.

ADD MORE WITH Add Ons...

Add extra style, protection and practicality to your Amarok, while still keeping it 100% Volkswagen.

Add Ons allow you to go beyond options and truly customise your vehicle. Whether you want added technology or need extra capacity with roof attachments or a tow bar, there's something in our **Add Ons** range for you.

KEEP IT 100% VOLKSWAGEN.

There are big advantages to purchasing approved accessories from us. **Add Ons** have all been designed with your Volkswagen in mind, so they're a perfect match for fit and style. They're also rugged, reliable and long-lasting.

KEEP YOUR Add Ons COVERED.

Most **Add Ons** include a two-year warranty, but the great news is that if you order and fit them when you purchase a new vehicle, we may be able to extend that to three years to match your vehicle's warranty.

SPORT AND STYLING.



16" AMAZONIT ALLOY WHEEL

6.5J x 16"

Prices do not include tyres.

Fitted price per wheel exc. VAT £141.67

Fitted price per wheel inc. VAT £170.00



18" ALUTECH BI-COLOUR ALLOY WHEEL

8J x 18"

Add these stylish bi-colour alloys to make your Amarok stand out. Only suitable for Highline 2.0 BiTDI 180PS 8-speed automatic 4MOTION with BlueMotion Technology. Prices do not include tyres.

Fitted price per wheel exc. VAT £222.50

Fitted price per wheel inc. VAT £267.00



19" ARAGONIT SILVER ALLOY WHEEL

8J x 19"

Only with wheel arch extension.

Prices do not include tyres.

Fitted price per wheel exc. VAT £320.83

Fitted price per wheel inc. VAT £385.00



19" ARAGONIT BLACK ALLOY WHEEL

8J x 19"

Only with wheel arch extension.

Prices do not include tyres.

Fitted price per wheel exc. VAT £335.00

Fitted price per wheel inc. VAT £402.00



FRONT BUMPER TRIM

Two-tone, Black/Silver front bumper trim that further enhances the front styling of your Amarok.

Fitted price exc. VAT £371.67

Fitted price inc. VAT £446.00



REAR STYLING BARS – BLACK

Dual 76mm powder-coated steel pipes. Edge mounted to allow no restrictions to your load space. Can be used with the three-piece hard tonneau cover.

Fitted price exc. VAT £425.83

Fitted price inc. VAT £511.00



REAR STYLING BARS – STAINLESS STEEL

Polished stainless steel finish. Edge mounted to allow no restrictions to your load space. Can be used with the three-piece hard tonneau cover.

Fitted price exc. VAT £625.83

Fitted price inc. VAT £751.00



STYLING BAR LIGHTS

Great for off-roading, these lights help to improve your field of vision in dark or unlit areas while off the beaten track.

Fitted price exc. VAT from £460.83

Fitted price inc. VAT from £553.00



SIDE BARS – POLISHED STAINLESS STEEL

These polished stainless steel side bars match the rear styling bars.

Fitted price exc. VAT from £394.17

Fitted price inc. VAT from £473.00



SIDE BARS WITH STEP PADS – POLISHED STAINLESS STEEL

Features two rubber step pads on each 76mm polished stainless steel tube.

Fitted price exc. VAT £445.00

Fitted price inc. VAT £534.00



SIDE BARS WITH STEP PADS – BLACK

Features two rubber step pads on each 76mm Black powder-coated steel tube.

Fitted price exc. VAT £399.17

Fitted price inc. VAT £479.00



LEATHER SEATS

Add a touch of luxury to the interior of your vehicle with these single colour, smooth, high-quality leather seats. Featuring matching stitching and your choice of pillow-effect or flat cushioning. Available in Black and Titan Grey.

RRP exc. VAT £1,208.33

RRP inc. VAT £1,450.00

LEATHER SPORT SEATS

Two-tone upholstery with complementary colours in either the side 'fillet' panels or mid-centre back and seat panels. Features stitching in the contrasting colour and a choice of pillow-effect or flat cushioning. Available in Titan Grey, Dark Red and Ocean Blue.

RRP exc. VAT £1,375.00

RRP inc. VAT £1,650.00





NEW

CHROME DOOR HANDLE COVER

If you want your Amarok to stand out from the crowd, adding these exclusive chrome handles is sure to make a statement.

Fitted price exc. VAT £51.67
Fitted price inc. VAT £62.00



NEW

CHROME TAILGATE HANDLE AND SURROUND

Add the perfect finishing touch to the rear tailgate of your Amarok with this chrome handle and surround.

Fitted price exc. VAT £29.17
Fitted price inc. VAT £35.00



NEW

CHROME SIDE MIRROR COVERS

Designed to perfectly fit the contours of your mirror, these chrome covers look great and are the perfect finishing touch for your vehicle.

Fitted price exc. VAT £79.17
Fitted price inc. VAT £95.00



NEW

CHROME FOG LIGHT SURROUNDS

Enhance the front of your vehicle with these eye-catching fog light surrounds.

Fitted price exc. VAT £26.67
Fitted price inc. VAT £32.00



NEW

CHROME SIDE INDICATOR SURROUNDS

Enhance the side of your vehicle with these stylish indicator surrounds.

Fitted price exc. VAT £10.00
Fitted price inc. VAT £12.00



SIDE WIND DEFLECTORS

These wind deflectors are not only stylish, but also help deflect rain and wind noise – offering added comfort while on the move. Available for front and rear, or front only.

Fitted price exc. VAT full set £57.50
Fitted price inc. VAT full set £69.00

Fitted price exc. VAT front only £39.17
Fitted price inc. VAT front only £47.00



THULE ROOF BARS

Increase load space with these sturdy roof bars. And if you use them with our roof bar accessories, you can fine-tune your vehicle to meet your needs.

Fitted price exc. VAT £177.50
Fitted price inc. VAT £213.00

ROOF BAR ACCESSORIES

Roof boxes	from £220.00
Kayak holder	£95.00
Ski and snowboard holder	£175.00
Bicycle holder	£85.00
Surfboard holder	£95.00

Please note: prices above include VAT, but exclude fitting.



TOWING BALL AND ELECTRICS

This removable 50mm ball towbar is capable of towing 2,800kg trailer loads. It also includes 13-pin electrics.

Fitted price exc. VAT £373.34
Fitted price inc. VAT £448.00

SAFETY AND SECURITY.



NEW

REVERSE PARKING CAMERA

This sophisticated rear-mounted parking camera provides a visual warning of obstacles directly behind your vehicle. It complements the audible rear parking sensors (if fitted) and is activated by selecting reverse gear. For maximum convenience, the image from the camera is displayed on the interior rear-view mirror and features guidance lines to reflect vehicle positioning when reversing.

Fitted price exc. VAT £375.00
Fitted price inc. VAT £450.00



TAILGATE LOCK

Secure your load area via your Amarok's remote central locking key. This security tailgate deadlock is designed specifically for the Amarok, and includes tailgate lock, deadlock motor and bespoke brackets.

Fitted price exc. VAT £155.83
Fitted price inc. VAT £187.00



REAR PARKING AID

This rear parking aid makes it much easier to manoeuvre your Amarok into tight parking spaces.

Fitted price exc. VAT £274.17
Fitted price inc. VAT £329.00



REVERSING SENSOR SWITCH

This handy switch enables you to disable the rear parking aid so you can reverse undisturbed when a trailer is attached. A green light on the switch reminds you that the sensors are not in use.

Fitted price exc. VAT £90.00
Fitted price inc. VAT £108.00

COBRATRAK

Keep your Amarok and its contents secure with CobraTrak. Volkswagen's partnership with CobraTrak stolen vehicle tracking means your vehicle's location can be pinpointed across Europe. The system uses the latest GPS/GPRS/GSM technology and can locate your vehicle to an accuracy of 10m. CobraTrak is Thatcham and insurer-approved and comes with a three-year Volkswagen warranty. A web upgrade is also available so you can track your vehicle using your computer or smartphone.

RRP exc. VAT from £385.99
RRP inc. VAT from £463.19



LOAD AREA SECURITY.



HARDTOP

This lightweight polycarbonate hardtop clamps easily to the body of the Amarok. Features gas-lift rear window with single lock operation, interior light, fold-out passenger-side window, driver's side sliding window, a front window slider

for easy cleaning and privacy glass on all windows. The hardtop can be used with load bed liners, but is not compatible with rear styling bars.

Fitted price exc. VAT £1,947.50
Fitted price inc. VAT £2,337.00



COMMERCIAL HARDTOP

This lightweight polycarbonate hardtop, with gas-lift privacy glass window, clamps to the body and is finished in White. Cannot be used with rear styling bars.

Fitted price exc. VAT £1,585.00
Fitted price inc. VAT £1,902.00



TOOL BOX FOR LOAD AREA

Lockable and safe storage for tools. The tool box spans the full-width of the load area between the wheel arches. Cannot be used with tonneau covers.

Fitted price exc. VAT £341.67
Fitted price inc. VAT £410.00



HARD TONNEAU COVER – 1-PIECE

Lockable, weather-resistant cover in durable PC/ABS plastic. Opens on two gas-lift struts and covers the entire rear load area. Available pre-painted in six Amarok colours. Cannot be used with rear styling bars.

Fitted price exc. VAT £1,251.67
Fitted price inc. VAT £1,502.00



HARD TONNEAU COVER – 3-PIECE

Lockable, weather-resistant three-piece cover in durable PC/ABS plastic. Opens on two gas-lift struts and is available pre-painted in six Amarok colours. Please note: the cover must be combined with rear styling bars.

Fitted price exc. VAT £1,251.67
Fitted price inc. VAT £1,502.00



ROLL-AND-LOCK COVER

A weather-resistant, vinyl coated aluminium cover that protects the load area. Can be opened in increments, allowing taller objects to be carried, while still protecting small items. Please ask your Van Centre for compatibility with other Add Ons.

Fitted price exc. VAT £1,083.33
Fitted price inc. VAT £1,300.00



SOFT TONNEAU COVER WITH ALUMINIUM FRAME

This waterproof cover, with an aluminium mounting securing it to the cargo bay, protects your load from the elements. Can be rolled back and held in place with two belts when not required. Cannot be used with rear styling bars.

Fitted price exc. VAT £300.83
Fitted price inc. VAT £361.00



ALUMINIUM TONNEAU COVER

Offers security and protection for your cargo. Made of sturdy aluminium, this lockable tonneau cover makes loading and unloading easy with the cover being supported by two strong gas-lift struts. Cannot be used with rear styling bars.

Fitted price exc. VAT £901.67
Fitted price inc. VAT £1,082.00

PROTECTION.



REAR CABIN GRID

Ideal for carrying long objects without scratching the roof. Black powder-coated steel. Mounts to the rear panel. Not with tonneau covers, hardtop or styling bars.

Fitted price exc. VAT £197.50
Fitted price inc. VAT £237.00



LOAD LINER – PLASTIC

This tough load liner fits snugly to the load floor, front wall, rear tailboard and side walls – protecting your Amarok's load area against damage.

Made from high-quality, long-lasting, durable, wipe-clean polyethylene.
Fitted price exc. VAT £241.67
Fitted price inc. VAT £290.00



UNDER-RIDE GUARD FOR GEARBOX

Helps to protect your gearbox when tackling rough terrain. Please note: can only be fitted in conjunction with the factory-fitted engine protection grille. Please ask your Van Centre for more details.

Fitted price exc. VAT £212.50
Fitted price inc. VAT £255.00



HEADLAMP PROTECTORS

This set of headlight protectors helps to ensure a long life for your headlights by preventing damage to the outer lens casing. The set also includes conversion decals essential for continental driving.

Fitted price exc. VAT £45.83
Fitted price inc. VAT £55.00



BONNET PROTECTOR

This handy bonnet protector will help to keep your Amarok's bonnet looking pristine and dent-free for years to come.

Fitted price exc. VAT £52.50
Fitted price inc. VAT £63.00



WATERPROOF SEAT COVERS

Protect your seats and headrests from moisture and dirt with these fitted, removable and machine washable waterproof seat covers. Available for both front and rear seats.

RRP exc. VAT from £67.50
RRP inc. VAT from £81.00



RUBBER FLOOR MATS

These practical, neutral odour, black rubber floor mats are designed to perfectly fit the floor of your vehicle. The mats are held firmly in place by making use of the attachment points provided on the floor. Available for both front and rear passenger areas.

RRP exc. VAT from £20.83
RRP inc. VAT from £25.00



CARPET FLOOR MATS

These deep pile carpet mats perfectly fit the floor of your vehicle. Made from tightly woven velour with a practical non-slip backing, the mats are held firmly in place by making use of the attachment points provided on the floor. Available for both front and rear passenger areas.

RRP exc. VAT from £30.83
RRP inc. VAT from £37.00

TECHNOLOGY.



KENWOOD CD/DIGITAL RADIO

This DAB radio system has a clever chip that eliminates breaks and distortion in reception. Connect your iPod and search by playlist, genre, artist and album.

Fitted price exc. VAT £289.17
Fitted price inc. VAT £347.00



KENWOOD DAB MULTIMEDIA SYSTEM

Make calls. Listen to music. Navigate in one go. The Kenwood DAB+ multimedia system features 7" touchscreen control, full European navigation with voice directions, Bluetooth® phone connectivity and music streaming, iPhone or iPod

control and charge, DVD, CD, USB and SD card music playback and HDMI and MHL on-screen mirroring for iPhone and Android. Please note: some features only work when the vehicle is stationary.
Fitted price exc. VAT £970.83
Fitted price inc. VAT £1,165.00



AUTODAB

This professionally installed DAB system lets you enjoy the benefits of digital radio. Choose from new digital stations and enjoy old favourites with improved audio quality. It also uses your vehicle's display to show song and artist information from certain stations.

Fitted price exc. VAT £187.50
Fitted price inc. VAT £225.00



DRIVE DIGITAL

Enjoy a wider choice of radio channels and improved sound quality with this professionally installed radio upgrade. You can browse stations and even pause and rewind while listening. It's also possible to connect music and USB devices for added choice.

Fitted price exc. VAT from £240.83
Fitted price inc. VAT from £289.00



BLUETOOTH® TOUCH PHONE KIT

This removable 2.8" colour touchscreen device features voice control, so you can make a call, or hear text messages, without your hands leaving the wheel. The system integrates with your vehicle's radio, which automatically mutes when a call is made or received.

Fitted price exc. VAT from £201.67
Fitted price inc. VAT from £242.00

MEDIA INTERFACE

Connect external audio sources such as MP3 players, iPods and USB sticks via the MEDIA-IN interface. Suitable for vehicles fitted the RCD 310 radio system. Comes with iPod lead. You may need a lead to suit your media device.

Fitted price exc. VAT from £248.33
Fitted price inc. VAT from £298.00



IPOD ADAPTOR

Control your iPod's play list through an existing audio or radio navigation system, as well as via the multi-function steering wheel if fitted to your vehicle. Your iPod is charged while connected. To check compatibility, please ask your Van Centre for details.

Fitted price exc. VAT £181.67
Fitted price inc. VAT £218.00



NSV BLUETOOTH® KIT

This attractive Bluetooth® kit seamlessly integrates into your cab and includes impressive features such as automatic audio system muting and phone pairing, voice control and the ability to recognise up to five phones and play music wirelessly through your vehicle's speakers.

Fitted price exc. VAT £180.00
Fitted price inc. VAT £216.00



CAB ACCESSORIES AND MERCHANDISE.



MULTI-ATTACHMENT POINT BRACKET

For retro-fitting the multi-attachment point to Startline models.

RRP exc. VAT £19.17
RRP inc. VAT £23.00



MULTI-ATTACHMENT POINT MAGNET

Useful magnetic holder for attaching pens and paper clips.

RRP exc. VAT £9.17
RRP inc. VAT £11.00

MULTI-ATTACHMENT POINT NOTE CLIP

A handy place to keep special notes and reminders of things to do.

RRP exc. VAT £9.17
RRP inc. VAT £11.00



BLACK LEATHER CD HOLDER

Transport and protect your CD collection with this smart leather CD holder.

RRP exc. VAT £11.25
RRP inc. VAT £13.50



MULTI-ATTACHMENT POINT PICTURE HOLDER

Enjoy special images or personal photographs of friends and family.

RRP exc. VAT £9.17
RRP inc. VAT £11.00

MULTI-ATTACHMENT POINT BRACKET AND CUP HOLDER

Cup holder with bracket for Startline.

RRP exc. VAT £20.83
RRP inc. VAT £25.00

Cup holder for Trendline and Highline.

RRP exc. VAT £15.83
RRP inc. VAT £19.00



MEN'S CHRONOGRAPH WATCH

Quality is at the core of this tough, but stylish, chronograph watch. It features a stainless steel case, domed glass lens, raised logo and a soft, but robust sports strap. Water-resistant to 10 atmospheres, it comes in an elegant gift box.

RRP exc. VAT £100.00
RRP inc. VAT £120.00



POLISHED CHROME VW KEYRING

Make a statement with this highly polished 35mm diameter chrome keyring. Featuring the iconic VW roundel, it's designed to make an impression wherever you go.

RRP exc. VAT £5.00
RRP inc. VAT £6.00



SILVER VOLKSWAGEN CUFFLINKS

For that finishing touch, choose from either polished silver or blue and white enamel cufflinks.

RRP exc. VAT £13.33
RRP inc. VAT £16.00

SERVICE AND WARRANTIES.

FINANCE AND INSURANCE.

When it comes to paying for your vehicle, we've got options including Contract Hire and Finance Lease, or Hire Purchase. We can also offer you competitive insurance.

A CHOICE OF PACKAGES.

Whether you prefer to lease your vehicles, with none of the concerns of ownership and the freedom to change models easily, or purchase outright to own the vehicle, we're here to help you make the best decision.

You can go flexible, by choosing a payment plan that suits your finances, with options to reduce your monthly costs and your repayment period. Or choose a fixed monthly price that allows you to budget confidently for the longer term.

You can even include your road tax and servicing costs to arrive at one simple, all-inclusive payment. For more information, pick up a finance brochure, or ask at your Van Centre.

VOLKSWAGEN INSURANCE.

Volkswagen Commercial Vehicles Insurance provides cost-effective and comprehensive motor insurance, as well as gap insurance, which helps replace your vehicle and protect you from any financial shortfall if it's written off.

INSURANCE BENEFITS INCLUDE:

- Free seven-day cover to allow you to drive your vehicle away.
- All repairs performed by approved repairers.
- Volkswagen Genuine Parts[®] used on all repairs.
- Courtesy vehicle provided during repair following an accident.
- Cover for breakage and damage to glass.
- Tools-in-transit cover (up to £1,000).
- In-vehicle personal belongings cover (up to £500).
- Vehicle recovery.
- 60-day European Union cover.
- Legal expenses cover (up to £100,000).

For more information about motor and gap insurance products, ask at your Van Centre, call **0800 316 7896**, or visit insurewithvwcv.co.uk.

SERVICING AND SUPPORT.

We're here to keep you moving, with our range of three award-winning¹ servicing and maintenance options, as well as free Roadside Assistance.

PAY MONTHLY.

This option is available for vehicles that are less than 12 months old and have covered less than 10,000 miles. It makes budgeting easier by splitting the cost of servicing into fixed monthly payments – whether you want Service only, Service and Maintenance or Service, Maintenance and Tyres.

PAY UPFRONT.²

If you can pay for more than one service upfront, we'll help by reducing your costs. Buy two upfront and you'll receive one interim and one full service at a discounted rate. Buy four and you'll receive two interim and two full services, with your next MOT also included.

PAY ON DEMAND.

If you're looking for freedom and flexibility with your servicing, it's good to know we're ready when you are. So with our third option, you can choose to pay for your services as and when you need them, with our National Service Pricing. Ask your Van Centre for an up-to-date pricing guide.

ROADSIDE ASSISTANCE.

We understand the need to keep you mobile. That's why all new vehicles come with three-year, unlimited mileage roadside cover. Should the unexpected happen, one call gets you straight through to a team trained to help you through any breakdown or accident. Supporting you every day will be a team of 95 vehicle technicians, fully-trained by Volkswagen and carrying the latest diagnostic equipment, specialist tools and parts.

ASSISTANCE BENEFITS INCLUDE:

- Assistance at home, by the roadside or place of work.
- Recovery to your preferred location.
- Onward travel, for you and your cargo.
- Cover 24 hours a day, 365 days a year.
- Free cover for three years (on new vehicles).
- Unlimited mileage.
- European cover.
- Option to extend cover beyond three years.

WARRANTIES.

You can count on us long after you purchase your Amarok, thanks to its comprehensive three-year, 100,000 mile warranty. You choose Volkswagen because you depend on your vehicle, year in, year out.

While your Amarok is under warranty, we'll fix any defect in manufacture or workmanship free of charge, even if you purchase and service the vehicle at different Van Centres.

EXTENDED WARRANTY.

You can also extend your warranty beyond the three-year, 100,000 mile period, choosing either Comprehensive or Major Component cover, as a one-off or monthly payment. For full details of cover levels, along with terms and conditions, please visit volkswagencvwarranty.co.uk where you'll also be able to obtain a quote and purchase an extended warranty.

PAINT AND BODY WARRANTY.

Your Amarok's exterior paintwork is covered against manufacturing defects for a period of three years, while its body sections and panels are covered against rusting through from the inside for 12 years. Some exclusions apply and the vehicle must be cared for using the guidance in your owner's manual.

PLEASE NOTE: Print processes do not allow exact reproduction of the paint and upholstery colours. Some of the vehicles shown are European specification and may be fitted with optional equipment or accessories that are available at extra cost, or do not reflect current specification. All data, specifications and prices are in accordance with information available at the time of going to print and are subject to change without notice. VAT is calculated at 20%. Vehicles not currently in UK stock and customer order vehicles may take a number of weeks for delivery. Certain combinations of vehicle specifications and factory-fitted extras are not compatible and therefore all orders received are subject to confirmation. Models, factory-fitted options and paint and upholstery options are subject to availability. Please check details and availability with an authorised Volkswagen Van Centre at the time of ordering.

Volkswagen Commercial Vehicle Finance is a trading name of Volkswagen Financial Services (UK) Limited, Brunswick Court, Yeomans Drive, Blakelands, Milton Keynes MK14 5LR. Registered in England number: 2835230. An offer of finance depends on certain conditions. Subject to status, indemnities may be required. Available to over 18s in the UK only. Volkswagen Commercial Vehicle Insurance is a trading name of Volkswagen Insurance Service (Great Britain) Limited, an appointed representative of Volkswagen Financial Services (UK) Limited, registered in England number: 2835230 (registered office: Brunswick Court, Yeomans Drive, Blakelands, Milton Keynes MK14 5LR). Volkswagen Commercial Vehicle Insurance motor insurance is sold, underwritten and administered by Allianz Insurance plc., registered in England number: 84638 (registered office: 57 Ladymead, Guildford, Surrey GU1 1DB). Volkswagen Financial Services (UK) Limited is authorised and regulated by the Financial Conduct Authority. Financial Services Register number: 311988. Allianz Insurance plc is authorised by the Prudential Regulation Authority and regulated by the Financial Conduct Authority and the Prudential Regulation Authority. Financial Services Register number: 121849. Volkswagen Financial Services (UK) Limited and Allianz Insurance plc are not part of the same corporate group.

THE VAN CENTRE NETWORK.



Our **dedicated Van Centre network** is at the core of everything we do and is always there to help. As a separate brand within the Volkswagen Group, it makes sense to make use of your nearest Van Centre – it's full of experts who understand your vehicle better than anyone else and can help you to get the most out of it.

With **69 Van Centres** and **29 Authorised Repairers**, you're only 45 minutes from our door, wherever your Amarok takes you.

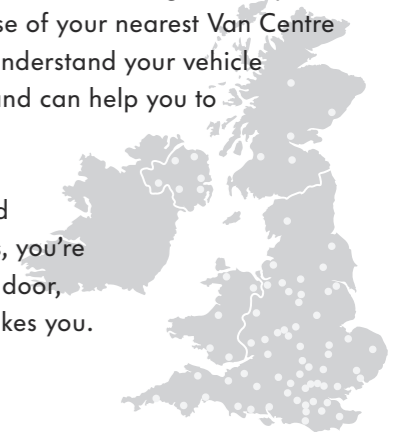

¹ Business Vans Awards 2014: Best Service Package for Van Owners.

² Class 4 MOT only. This option is available to all new and used vehicles up to four years old or with less than 80,000 miles on the clock. Services must be used consecutively prior to vehicle reaching eight years old.

The Amarok

VW MY15 AMARO

This brochure supersedes all previous publications.

Issue: June 2014

www.volkswagen-vans.co.uk