

# Amarok



Commercial  
Vehicles

✓ **Truly versatile**  
Great for work or play

✓ **Luxurious interior**  
Packed with style and technology

✓ **Cut your fuel bills**  
New BlueMotion Technology engine

## Strength to perform

Conquer any terrain and task with Volkswagen's intelligent pick-up



## INSIDE



**Off-road ready**  
Options that are just as  
rugged as your Amarok



**7** ways your  
Van Centre  
can help you

**PLUS** Tips for picking your ideal vehicle ● How our warranty works for you ● BlueMotion Technology explained

# Volkswagen Amarok: for when the going gets tough



BORN IN THE mountains of South America, the Amarok is a pick-up unlike any other. It's every inch a true off-roader – a rugged workhorse for work or play. But, with car-like driving comfort and a refined interior, the Amarok redefines expectations of a modern pick-up.

The 2.0-litre BiTDI twin-turbo diesel offers 180PS for outstanding off-road, cargo-carrying and load-hauling capabilities, making it truly great for work and bridging the gap between a van and a pure off-roader. The comfortable interior and convenience of an optional eight-speed automatic gearbox also mean it's as at home in town as it is escaping for a weekend in the country.

Now, with the addition of BlueMotion Technology, the Amarok is more economical than ever before. No wonder it's loved by drivers and the media alike, winning 'Pick-Up of the Year' awards from *What Van?*, *4x4 Magazine* and *Auto Express*.



## INTRODUCING THE AMAROK

- ✓ Choice of two 2.0-litre turbo-diesel engines: 140PS and 180PS BiTDI
- ✓ Best-in-class cargo area of 2.5m<sup>2</sup>
- ✓ Impressive off-road performance with selectable or permanent 4MOTION® four-wheel-drive
- ✓ Startline, Trendline and Highline trims offer wide choice of ownership
- ✓ Payloads up to 1,145kg
- ✓ **NEW** BlueMotion Technology



Make your next move

Find out why Volkswagen is a brand you can trust

> p6

Go straight to the Amarok to learn more

> p8

**Contact us now:** To find the location of your nearest Van Centre, get a brochure or book a test drive: ☎ 0800 717131 🌐 [www.volkswagen-vans.co.uk](http://www.volkswagen-vans.co.uk)

**Get connected:** 🐦 [Volkswagen\\_CV](#) 📘 [VolkswagenCommercialVehiclesUK](#) 📺 [vwcommercialvehicles](#) 🌐 [www.volkswagen-vans.co.uk/vanmail](http://www.volkswagen-vans.co.uk/vanmail)

# Expect the extraordinary

Thanks to innovative technology and clever design features, the Amarok is a pick-up that is much more than the sum of its parts

## True off-roader

The Amarok is a genuine off-roader. With an approach angle of 28°, an exit angle of 23° and wading depth of up to 500mm, the Amarok can easily tackle steep hills and small fords. It can even handle roads with a lateral tilt of 50°.



## Ready for work

A ladder-frame chassis means that the Amarok is great off-road, and great for work, too. It's able to hold a Euro pallet between the wheel arches, and a maximum payload of 1,145kg and a towing capacity up to 3,200kg gives it plenty of potential.



## BlueMotion Technology

BlueMotion Technology is available on manual and auto transmission models. In manual form, the Amarok has 180PS and 400Nm of torque, but returns up to 37.2mpg (combined) with CO<sub>2</sub> emissions of 199g/km.



## Safe and sound

The Amarok features advanced systems that improve both off-road performance and safety. These include an Electronic Stabilisation Programme, Hill Hold Assist, Hill Descent Control, off-road ABS and Trailer Stability Control.



## 4x4 heritage

From its first four-wheel-drive model in 1983 to the current advanced 4MOTION® system used across the van range, Volkswagen Commercial Vehicles has a long heritage of four-wheel-drive vehicles.



## The right drive

The Amarok takes four-wheel-drive to a new level, with Selectable or Permanent 4MOTION® for optimal off-road performance or Selectable 4MOTION® for better two-wheel-drive economy on paved roads.



## Trust your Van Centre network

OWNING AN AMAROK is about more than just the vehicle – it's about support, too. That means helpful advice, affordable finance, and maintenance and servicing to keep it running more efficiently for longer.

That's where our network of over 100 Van Centres and Authorised Repairers comes in. All our staff are fully trained to solve any problem you may have.

• Find out how your local Van Centre can help right now – see page 26.



Find your nearest Van Centre on [www.volkswagen-vans.co.uk](http://www.volkswagen-vans.co.uk) or call 0800 717131

# Volkswagen round-up

Accolades and awards • BlueMotion Technology across the range • New trims for Caddy and Transporter

## Volkswagen vans shine under awards spotlight



Volkswagen Commercial Vehicles has won a host of awards in recent months, including the title of 'Manufacturer of the Year' for 2012 from *Van Fleet World*.

The magazine also awarded the Transporter its 'Best Medium Van' prize, while the Caddy was 'Best Small Van'.

The Transporter was named 'Medium Panel Van' and 'Fleet Van of the Year' for 2012 by *Fleet Van*, while the top-of-the-range Transporter Sportline was *What Van?* magazine's 'Editor's Choice'.

The Caddy 4MOTION® was *What Van?*'s '4x4 of the Year', while the Amarok won 'Pick-up of the Year' from *What Van?* and 'Best Pick-up' at the British Insurance Vehicle Security Awards. The Amarok is also *4x4 Magazine*'s 'Pick-up of the Year'.

To cap it all, Volkswagen Commercial Vehicles topped the *Fleet News* FN50 Reliability Survey as the 'Most Reliable Van Manufacturer', with the Caddy, Transporter and Crafter all in the top six.

These awards recognise and prove that our promise to you is truly alive and well. That promise is to bring you products that are more versatile, reliable, efficient and better value for money than ever.



### Caddy Match sells out fast

The limited-edition Caddy Match – packed with a wealth of the most popular options – was a huge hit before orders closed on April 30. Make sure you don't miss the next special edition – follow our Twitter feed at [Volkswagen\\_CV](#)



### BlueMotion Technology is here

BlueMotion Technology offers increased fuel efficiency and reduced carbon emissions, and it's available on most models in our range. To find out how BlueMotion Technology can help cut your fuel bills, turn to page 16 to learn more, or ask your Van Centre for details.



## Finance that makes buying your vehicle easy

Getting your hands on a new van or passenger carrier from Volkswagen Commercial Vehicles could be even more affordable – and easier – than you think.

We've got a great range of finance deals that allow us to tailor a solution to the needs of your business and your pocket. That might be a lower initial deposit, or regular, fixed monthly payments that include pre-planned costs

for servicing and maintenance. It all helps you know exactly how much your vehicle will cost now and over the long term.

We have special finance offers, too, which offer you even more value for money, and they're regularly updated. You can find all the latest deals at [www.volkswagen-vans.co.uk](#), or pop into your local Van Centre to find out how we can help you.



### Get connected with us online

We've got lots of ways to stay up to date with all that's going on in the world of Volkswagen Commercial Vehicles.

Sign up to Van Mail for the latest news and finance offers, or follow us on Twitter and like us on Facebook for a great mix of news, tips and exclusive competitions.

Our YouTube channel is packed with useful and fun videos, too. To stay connected, just add the links below to your browser's favourites.



## New trims offer outstanding value

Now there's even more choice for Caddy and Transporter buyers, thanks to the introduction of new trims that offer a great pack of features at one easy price.

That makes buying a van with a high level of specification really simple and delivers you great value for money.

On Transporter panel vans and kombis, and Caddy panel vans,

Trendline and Highline trims bring extra features to the already well-appointed standard model. On the Transporter, you can also go for the ultra-high-level Sportline trim to really mark out your van and your business from the pack.

If you need to add even more features, there's an extensive list of factory-fit options and Add On accessories.



### Get even more with Add Ons

Add Ons is Volkswagen Commercial Vehicles' range of accessories, with lots of work, technology and leisure products that can be fitted by your Van Centre at any time. See pages 38-44 for more details.

Contact us now: To find your local Van Centre, get a brochure for a different model, or book a test drive: 0800 717131 [www.volkswagen-vans.co.uk](#)

Get connected: [Volkswagen\\_CV](#) [VolkswagenCommercialVehiclesUK](#) [vwcommercialvehicles](#) [www.volkswagen-vans.co.uk/vanmail](#)

# Contents

All of your Amarok questions answered

What is it like to drive?

>p10

Which engine do I need?

>p14

What trims are available?

>p18

What support can I expect?

>p24

How much does it cost?

>p28

What options are available?

>p29

What Add Ons can I choose?

>p38

What are the facts and figures?

>p46



"You can use the Amarok as a workhorse during the week, and then just pressure-wash it down and use it as a normal car to go out in at the weekend."

Matthew Swales



"The Amarok's towing capacity is fantastic. The fact that it's a capable vehicle off-road as well as on-road makes visiting customers much easier."

Ian Caulkett

Take the rough with the smooth in an Amarok

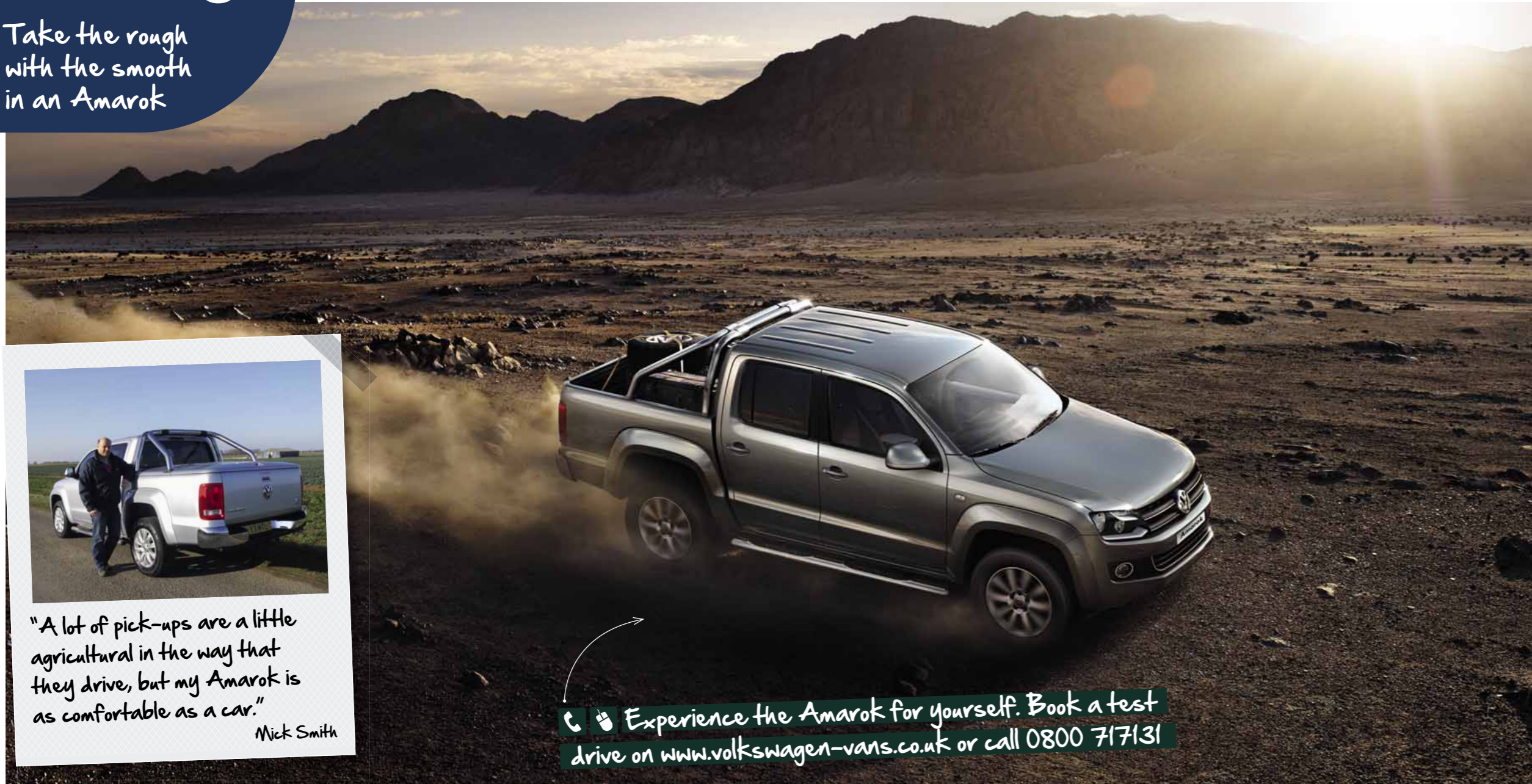

"A lot of pick-ups are a little agricultural in the way that they drive, but my Amarok is as comfortable as a car."

Mick Smith

☎️ 🖱️ Experience the Amarok for yourself. Book a test drive on [www.volkswagen-vans.co.uk](http://www.volkswagen-vans.co.uk) or call 0800 717131

## Rugged or refined: whatever you need

Whether it's cruising on paved surfaces or tackling testing off-road conditions, the Amarok is equipped to deliver

**H**oned on South America's rough mountain terrain, it's no surprise that the Amarok is such a formidable off-roader. With its powerful 2.0-litre TDI engines and intelligent 4MOTION® system, it'll take you anywhere you need to go.

On-road performance is just as composed, thanks to the Amarok's refined ride quality and the dynamic driving benefits of four-wheel drive.

### Dependable four-wheel drive

At the heart of the Amarok's off-road performance is Volkswagen's advanced 4MOTION® four-wheel-drive system, which maintains optimum traction on all road surfaces. Even when the going gets extreme, the Amarok is up to the challenge – wading small fords, handling steep inclines and uneven terrain. All without compromising its load-carrying capacity.

The 140PS and 180PS turbo-diesel engines both have a six-speed manual gearbox as standard, while new for 2012 is an innovative eight-speed automatic available on the 180PS Highline 4MOTION® Permanent.

Designed to tackle the toughest off-road terrains, the Amarok has an Electronic Stabilisation Programme

(ESP) fitted as standard – part of an impressive range of safety features, which include on- and off-road anti-lock braking systems, an Electronic Differential Lock, and Trailer Stability Control.

### Sure-footed on any incline

The Amarok's Hill Hold Assist keeps it stationary on steep inclines when pulling away, while Hill Descent Control regulates engine speed and applies the brakes if necessary so that you drive down slopes in a safe and controlled way.



Volkswagen's 4MOTION® four-wheel-drive system is at the heart of the Amarok's off-road performance

### 4MOTION

**Permanent**  
4MOTION® Permanent is unique among pick-ups and great for convenient off-roading. It keeps the four-wheel-drive system constantly engaged whether you're on- or off-road, so power is always sent to the wheels with the most grip. It's available on the Amarok Highline – the manual model comes with the more pliant standard leaf-spring suspension while the automatic comes with the heavy-duty leaf suspension

**Selectable**  
4MOTION® Selectable is ideal for rugged off-roading. It lets you switch between high- or low-range four-wheel drive for more extreme conditions. There's also a two-wheel-drive option for a more fuel-efficient performance. Available on all Amaroks, it comes with heavy-duty leaf-spring suspension for handling heavy loads.

# Feel at home in the wild

Comfortable and packed with features – the Amarok has an interior that sets it apart from the off-road pack

From the outside, the Amarok is as rugged and tough as it is stylish. Inside, it's also built to last, with the comfort and feature-packed functionality you'd expect from a Volkswagen. The three-seat rear bench means there's room for five people, too.

### Car-like comfort

The premium look and feel of the Amarok interior and the clear, functional design of the dashboard set new standards in this class. You'll think you're behind the wheel of a passenger car. The ergonomic front seats offer individual height adjustment, and there's plenty of head- and legroom for passengers front and rear.

### Feature-packed as standard

The Amarok Startline features electric windows, Climatic air-conditioning and driver and front passenger airbags. Upgrade to Trendline and Highline for even more style and comfort. You can choose factory-fitted options, as well as Add On accessories that you can buy and fit at any time. So, whether you're after leather seats, upgraded audio or sat-nav systems, there's something for you.



The premium look and feel of the Amarok interior sets new standards in its class



"It's fully equipped and very comfortable, like a luxury car. It's also very quiet in the cabin, even at high motorway speeds, which makes long journeys easy."

Matt Swales

### Tough, clear dashboard

All the controls are easy to use, so you stay focused on the road. The dash is as tough as you'd expect for a pick-up, but it looks and feels a cut above the rest.

### Comfy seats

Our supportive seats come in attractive, hard-wearing fabrics and leather.



### Cool and comfortable

Air-conditioning is standard to help keep you cool. On Trendline and Highline models, the system is fully automatic, too.

### Entertainment and sat-nav

All Amaroks have the RCD 210 or RCD 310 radio/CD players.

### Why not add...?

Satellite-navigation – our RNS 315 system has maps for western Europe on an internal 4GB flash memory.

### Three-spoke steering wheel

The three-spoke steering wheel is designed to be comfortable and easy to use on- or off-road.

### Why not add...?

A multi-function steering wheel – this lets you control the audio system without taking your hands off the wheel.



## An easy-to-load, spacious cargo area

THE AMAROK HAS the widest load area in its class – 1.22m between wheel arches, which is enough to fit a Euro pallet sideways. No other pick-up can match this. With a load area of 2.52m<sup>2</sup> and payloads up to 1,145kg, the Amarok is a hugely practical workhorse. The low sill height makes loading easy, while the load compartment light means you can work in the dark.



  Your Van Centre can help you pick options that are right for you. Call 0800 717131 or visit [www.volkswagen-vans.co.uk](http://www.volkswagen-vans.co.uk) to find one near you

# Engines

Technology that helps to cut fuel bills and lower emissions

## Refined power at the ready

With a choice of two powerful 2.0-litre turbo-diesel engines, you can tackle any terrain while keeping your fuel bills low

The Amarok comes with a choice of 2.0-litre TDI engines – a 140PS unit on Startline models and the twin-turbo 180PS BiTDI engine. They produce enough power to cope with the heaviest loads and toughest off-road terrain, yet always remain refined.

### Powerful contender

The Amarok's 180PS engine delivers up to 400Nm of torque – a match for rivals with much larger-capacity engines. That's enough punch to haul payloads up to 1,145kg and offer a towing capacity of up to 2,800kg, while still offering fuel economy of up to 37.2mpg

(combined). It's all delivered through either a six-speed manual or a new, eight-speed automatic gearbox. The 140PS engine produces an impressive 340Nm of torque, too, while delivering up to 36.2mpg (combined).

### Economical thinking

For 2012, the Amarok benefits from BlueMotion Technology (on 180PS Permanent 4MOTION® Highline models). This uses start/stop, brake energy recuperation, low-rolling-resistance tyres and cruise control to cut fuel consumption to 37.2mpg (combined) and CO<sub>2</sub> emissions to 199g/km. Turn the page to learn more.

### Engine specifications

See page 46 for full engine data



### Add a sat-nav

A sat-nav system can plot shorter routes and prevent you making wrong turns – some can even navigate around traffic jams. It all helps cut fuel consumption.



### Travel light

Your Amarok can carry a lot of cargo, but you shouldn't just use it as a mobile storage unit. Reducing a vehicle's weight is one of the easiest ways to improve its fuel economy.

### Top tips to help you save fuel

Cutting fuel use isn't just about engine technology – it's also about being clever. Follow our four tips to make your Amarok as economical as possible.

### Use your Amarok's gearshift indicator

A gearshift indicator is fitted to all Amaroks. It helps you change gear at the most efficient times, which cuts fuel use and lowers emissions.



### Check your tyres

Up to 20% of a vehicle's fuel consumption is used in overcoming the tyres' rolling resistance. It's even more if your tyres are underinflated. So, check them regularly.



### Why torque matters

Torque is often more important than power when it comes to an engine's performance. If you carry heavy cargo often, pick an engine with lots of torque. It will move a heavy load from a standing start better than one with less torque, and keep it moving more easily. A torquey engine may even use less fuel, because you may not need to rev it as much to get the best out of it.



# More miles, less impact

BlueMotion Technology lowers your fuel costs and CO<sub>2</sub> emissions, and it's available on the Amarok Highline

At Volkswagen, we're as keen as you are to reduce the amount of fuel our vehicles use and their emissions. We're aware that fuel costs are a big burden for every driver, so improving our vehicles' efficiency only helps to deliver even better value to you. That's why we've introduced BlueMotion Technology to the Amarok range.

## The power of technology

All Volkswagens that carry the BlueMotion Technology badge include our energy-saving solutions – start/stop, low-rolling-resistance tyres, energy recuperation and cruise control – as standard. Together, they create instant

fuel savings and lower CO<sub>2</sub> emissions, bringing improved fuel economy. The benefit is money – and time – saved at the pumps.

## One engine, all the options

BlueMotion Technology is available on the 2.0BiTDI 180PS 4MOTION® Permanent Highline. It delivers combined fuel economy of 37.2mpg and cuts carbon dioxide emissions to 199g/km on the manual model.

The benefit of BlueMotion Technology is that the savings come without compromise, as you can add almost any of the factory-fit options that you like – your Van Centre can help you choose the best ones for you.



**BlueMotion Technology specifications**  
See page 46 for full engine data

Manual	Automatic
<p>2.0BiTDI 180PS</p> <p>BlueMotion Technology</p> <p>Combined up to 37.2mpg</p> <p>CO<sub>2</sub> from 199g/km</p> <p>Torque 400Nm</p>	<p>2.0BiTDI 180PS</p> <p>BlueMotion Technology</p> <p>Combined up to 35.3mpg</p> <p>CO<sub>2</sub> from 211g/km</p> <p>Torque 420Nm</p>

## How BlueMotion Technology works to lower your fuel bills and CO<sub>2</sub> emissions

BlueMotion Technology is available on the 180PS 4MOTION® Permanent Highline and is made up of four clever elements. Together, they make significant reductions in fuel consumption and CO<sub>2</sub> emissions, which keeps money in your pocket and reduces the impact on the world around us. Here, you can learn more about these elements and what they do.

### Cruise control

By keeping your vehicle at a constant speed, cruise control saves fuel that would normally be wasted when your speed fluctuates. It is especially useful for driving over long stretches, because it stops your speed creeping up unintentionally and reduces driver stress.



### Low-rolling-resistance tyres

Fitting tyres with low rolling resistance means that the engine doesn't have to work as hard to get your vehicle moving – or keep it moving. It all helps to save fuel and reduce carbon emissions.



### Start/stop

Start/stop allows you to save fuel at traffic lights. When you stop, put your vehicle in neutral, release the clutch and the engine automatically switches off, saving fuel and reducing emissions. When you're ready to go, depress the clutch and the engine starts up again.



### Regenerative braking

When braking, energy during deceleration is wasted. Our energy recuperation system uses some of that momentum to turn the alternator and charge the battery. If the battery is well-charged, the engine has to do less work turning the alternator to keep it topped up. This cuts fuel use and emissions.

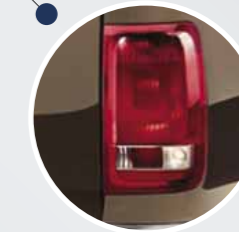

# Trims

A great range of trims that offer value and choice

The Startline is a rugged workhorse with outstanding load-hauling and terrain-tackling performance. It's packed with car-like features and comfort, too



Startline

## Ready for any challenge, any time

The Amarok Startline has a generous level of standard features that deliver practicality, performance and comfort

**T**he Amarok is a rare thing among pick-ups: it's practical and robust enough to handle the toughest terrains and loads, yet has road-car refinement for everyday driving.

With 16" alloy wheels and a body-coloured front bumper, the Amarok Startline looks the part. It acts the part, too, thanks to a class-leading load area and standard-fit Electronic Stabilisation Programme (ESP). This clever safety system automatically adjusts to the load conditions and incorporates a host of driver aids, such as Hill Hold Assist and Trailer Stability Control.

### Quality as standard

The Amarok Startline's interior also sets it apart from its rivals. Well designed and comfortable, it's got the reassuring build quality you'd expect from Volkswagen.

Startline models have Climatic semi-automatic air-conditioning, front and rear electric windows, airbags and an RCD 210 radio with a single CD player. Other thoughtful touches include a useful 12V socket in the centre console.

### Robust and refined

With rubber flooring, solid build quality and large storage areas in the doors, the Startline's cab is tough and versatile enough for a hard day's work. In the rear, all three passengers benefit from individual headrests and a three-point seat belt, while the rear seats can also be folded in part or entirely to create more space.



The standard-fit Electronic Stabilisation Programme helps keep your Amarok stable during emergency manoeuvres



### Electric windows

Typical of its car-like features, the Startline comes with electric windows in the front and rear as standard.

### Startline features



- ✓ 4MOTION® Selectable
- ✓ 16" Taruma alloy wheels
- ✓ Remote central locking
- ✓ Body-coloured front bumper
- ✓ Climatic semi-automatic air-conditioning system
- ✓ Electrically adjustable, heated door mirrors
- ✓ 12V socket in centre console
- ✓ Driver and passenger airbags
- ✓ Electric windows
- ✓ RCD 210 radio/single CD player
- ✓ Four load-lashing rings
- ✓ Electronic Stabilisation Programme (ESP)
- ✓ Hill Hold Assist
- ✓ Hill Descent Control
- ✓ Thatcham Category 1 alarm and immobiliser

Trendline

# Look cool, feel cool – all the time

The Trendline trim ensures your Amarok turns heads, and adds cab comfort features, such as automatic air-con and cruise control

The Trendline trim takes the Amarok's great looks and comfortable, feature-packed interior, and adds even more for good measure. On the outside, 17" Aldo alloy wheels, body-coloured door mirrors, extended wheel arches, a front bumper with



Trendline models are equipped with 17" Aldo alloy wheels, and extended wheel arches

chrome detailing and front fog lights all bolster the Amarok's bold, purposeful look.

### Make driving a breeze

At the wheel, cruise control helps to make journeys relaxing and a trip computer keeps you informed, while the addition of automatic, Climatronic two-zone air-conditioning keeps you and your passengers perfectly chilled. The excellent six-speaker RCD 310 single CD/radio player keeps everyone entertained, too.

### Cab kit that's there to suit you

The Trendline interior has Trail cloth upholstery with a leather-trimmed steering wheel, gear knob and handbrake. The neat, functional layout is enhanced with a silver inlay on the gear lever console and door handles, and there's a front centre armrest, too.

Practical touches include two multi-use dash mounts for attaching a cup-holder, pen-holder or similar. You'll also find storage drawers under the seats, and 12V sockets in the dash, centre console and load bay, as well as driver and passenger grab handles.



### Cruise control

Cruise control is standard on Trendline and Highline models. By keeping your Amarok at a constant speed, it reduces driver stress and helps keep fuel bills low – especially on long journeys.



### Stay cool

The Climatronic air-con system with two-zone temperature adjustment automatically sets and regulates the interior temperature, so you're comfortable whatever the conditions outside.



With the Trendline, you get all the practical, heavy-duty load-carrying capacity with comforts such as cruise control and automatic air-conditioning as standard

### Trendline features

(In addition to Startline)



- ✓ 17" Aldo alloy wheels
- ✓ Body-coloured door mirrors, handles, wheel arch extensions and front bumper
- ✓ Front fog lights
- ✓ Climatronic two-zone automatic air-conditioning
- ✓ Leather-trimmed steering wheel, gear knob and handbrake handle
- ✓ Cruise control
- ✓ Trip computer with multi-function display
- ✓ RCD 310 CD/radio with six speakers
- ✓ Three 12V sockets
- ✓ Front centre armrest
- ✓ Storage under front seats
- ✓ A-pillar grab handles on driver and passenger side
- ✓ Silver inlay around gear lever console

**Highline features**  
(In addition to Trendline)



- ✓ Front and rear parking sensors
- ✓ 18" Durban alloy wheels
- ✓ Chrome rear bumper with integrated step
- ✓ Chrome/body-coloured door mirrors
- ✓ Polished stainless-steel side bars
- ✓ Heated front seats
- ✓ Privacy glass
- ✓ Leather upholstery
- ✓ Dimmable dashboard illumination



Whether you're driving on smooth A-roads or tackling rutted tracks, you'll always remain comfortable in the Amarok's solidly built, luxurious interior

The Highline is every inch the modern pick-up. Its bold, muscular styling, chrome detail and smart alloys give it a dynamic presence

Highline

# Elevated thinking

The Highline trim adds a wealth of fabulous features that make the Amarok a paragon of practicality, comfort and style – inside and out

If you want to make your mark, then the Highline is the trim for you. It takes the Trendline's generous features and adds even more to create a 4x4 pick-up that really stands out from the pack.

There are 18" Durban alloy wheels, chrome-and-body-coloured door mirrors, a chrome rear bumper with integrated step, polished stainless-steel side bars and privacy glass. Together, they give the Highline a sharp new look. And Highline is the only Amarok with selectable and permanent 4MOTION®.

### The ultimate level of luxury

Inside, the quality image continues. Vienna leather and leatherette upholstery – with heated front seats – is combined with the Trendline's leather steering wheel, gear knob and handbrake to add even more style and comfort. The Highline also comes with the upgraded RCD 310 single CD/radio with six speakers and the automatic, Climatronic two-zone air-conditioning from the Trendline, and adds front and rear parking sensors for good measure.



Highline models have top-of-the-range features such as leather, privacy glass and 10-spoke 18" Durban alloy wheels, adding quality and refinement to driver appeal



### Smooth sounds

The RCD 310 radio/CD player has six speakers and a large display for clear channel navigation

### Parking is easy

Front and rear parking sensors make your job easier by warning when you're getting too close to something. Great for parking in those tricky spaces

**Your Van Centre can help you pick options that are right for you. Call 0800 717131 or visit [www.volkswagen-vans.co.uk](http://www.volkswagen-vans.co.uk) to find one near you**

# Full support right from the start

We want to make sure that using your Amarok is as hassle-free and cost-efficient as possible, so every vehicle comes with a three-year warranty and a choice of finance, servicing and insurance options. It all helps to keep the big issues covered



## A three-year warranty that lasts up to 100,000 miles

All Amaroks get a three-year, 100,000-mile warranty – and so do any factory-fit options that you buy. The vehicle warranty is made up of:

- A two-year manufacturer's warranty with unlimited mileage
- A third-year Van Centre warranty, up to a maximum of 100,000 miles

Even if you exceed 100,000 miles during your first two years, the manufacturer's two-year warranty will still be valid.

### Want cover for longer?

You can extend your vehicle warranty online or by phone. You can choose Comprehensive or Major Component cover and either one-off or monthly payments. Call **0845 641 9712** or visit [www.volkswagencvwarranty.co.uk](http://www.volkswagencvwarranty.co.uk) for details.



## Service options designed to fit your business perfectly

It's only natural that you want to keep your vehicle running at its best. Getting it serviced at a Volkswagen Van Centre is a great way to ensure that's exactly what happens. However, when it comes to servicing, we know every business has different needs. That's why we've developed three different service options for you to choose from:

- Pay Monthly
- Pay Upfront
- Pay On-Demand

Whichever suits your business best, you can rest assured that when you book in your vehicle, it'll be looked at by Volkswagen-trained technicians and they'll use only Volkswagen quality parts. What's more, there's a two-year warranty on the parts and one on labour.

### For more details

visit [www.volkswagen-vans.co.uk](http://www.volkswagen-vans.co.uk), or call **0800 717131** to learn more.



## Volkswagen Insurance keeps you covered\*

Volkswagen Commercial Vehicle Insurance can provide you with cost-effective, comprehensive motor insurance. Look at some of the benefits:

- Seven-day free cover to allow you to drive your vehicle away knowing it's insured
- All repairs performed by approved repairers
- Volkswagen quality parts on all repairs
- Courtesy vehicle provided during repair following an accident
- Cover for breakage and damage to glass
- Tools-in-transit cover (up to £1,000)
- In-vehicle personal belongings cover (up to £500)
- Vehicle recovery
- 60-day European Union cover
- Legal expenses cover up to £100,000

We also offer a range of gap insurance products. These help you replace your vehicle or protect you from any financial shortfall if it is written off.

### For more details

visit [www.insurewithvwcv.co.uk](http://www.insurewithvwcv.co.uk), call **0800 316 7896** or pop into your Van Centre and ask for a Flexible Finance brochure.

\* Terms and conditions apply

"If your vehicle's not working, you're not working. That's why we're here to help"



## Flexible Finance that makes things affordable

We can also make buying a new van more affordable in the first place. Speak to us about our selection of finance options, which include:

- Contract hire
- Finance lease
- Lease purchase
- Hire purchase

### For more details

visit [www.volkswagen-vans.co.uk/finance](http://www.volkswagen-vans.co.uk/finance) or pick up our Flexible Finance brochure at your nearest Van Centre.



## Three years' Roadside Assistance

Sometimes, the unexpected happens. If it does, your new Amarok comes with an unlimited-mileage recovery and assistance package. It lasts the same three years as your warranty and operates 24 hours a day, 365 days a year.

Cover is available across the UK and most of Europe. Our fully trained technicians can diagnose most problems at the roadside and they use Volkswagen quality parts.

### Learn more

Visit your Van Centre to get a Volkswagen Roadside Assistance handbook, visit [www.volkswagen-vans.co.uk/aftersales/roadside-assistance](http://www.volkswagen-vans.co.uk/aftersales/roadside-assistance) or call **0800 77 71 72**



## Van Centres – always there for you

Our dedicated Van Centre network is the backbone of everything we do, with more than 100 Van Centres and Authorised Repairers throughout the UK

Our Van Centre network offers a wide range of services, from MOTs to accessories, servicing to fully fitted parts. Not only that, but we use Volkswagen quality parts and you get dedicated staff who understand your vans intimately. So pop in for a coffee and a chat, and find out what your Van Centre can do for you.

Turn the page to learn more about our Van Centre network

# 7 ways your Van Centre can help you right now

Make full use of your nearest Van Centre – it's full of Volkswagen experts who know your vehicle better than anyone and who can help you to get the best out of it

**Picking a van that's perfect for your needs**  
We know that choosing your next van or passenger carrier is a big decision. You want a vehicle that works as hard as you do, both now and for the long-term – one that's versatile, cost-effective and reliable. We're here to help make your choice easier.  
Our Van Centre experts can offer advice on every model in the range and help you pick the right vehicle and factory-fit options for your business. They can also advise you on the best finance packages to ensure that your payments make financial sense.



Always on hand to help



**Quality servicing you'd expect at a price you wouldn't**  
Unpredictability and moving goalposts are part of life for a modern business, making it difficult to predict how many miles your vehicle will do in a year, or how long you'll need to keep it. Our National Service Pricing is designed for customers who need the flexibility of being able to book their vehicle in for a service whenever it needs it. When you do, our technicians will do everything necessary to ensure that your vehicle is back on the road, working hard for your business, as soon as possible.



**Express Visual Checks – peace of mind for free**  
Your Van Centre or Authorised Repairer can give your vehicle a free, 29-point Express Visual Check for complete peace of mind. You'll be given a comprehensive report, with the results clearly explained, and your technician will talk you through what work may need to be done in the future, so you can plan ahead and budget for it. If something needs urgent attention, you can get a precise quote before any work is done – and all the Volkswagen parts are covered by a two-year warranty.

**Accessories designed to help you get more from your van**  
Perhaps you've bought a van and your needs have changed – maybe you need a towbar or a roof rack, or perhaps you want to give your van some extra style. That's where Add Ons comes in. Add Ons is an extensive range of Volkswagen-approved accessories, available to buy and be fitted at your local Van Centre. We've got everything from towbars to tailgate spoilers, load nets to leather seats and sat-nav systems to stunning alloy wheels.



**Fast, hassle-free van rental for one-off jobs**  
Need another van for just a short while? We can hire you any vehicle from our fleet, as well as passenger-carrier versions of the Transporter and Crafter if you need to move people.  
**For more information, call the Van Rental team on 01908 467450**

**Fully fitted parts for a fixed price – and not a penny more**  
The pricing of all our Volkswagen quality parts is straightforward and clear, so you know exactly how much you're paying. Even better, when they're fitted by trained technicians at a Van Centre or Authorised Repairer they come with two years' warranty and 12 months' warranty on labour. If your van is over five years old, ask us about our Economy Parts range. This is a great-value way to help keep your vehicle 100% Volkswagen – it uses high-quality parts that come with a two-year warranty.



**Taking the worry out of tyres**  
Why run around looking for a fitter who has your tyres in stock? Let us fit new tyres when your van is in for its service and it'll keep your van off the road for less time. We have a huge range of tyres for all Volkswagen vans, from economy to premium brands, including winter tyres.



**What else can we do?**  
Loads! Just pop into any Van Centre and ask us. For example, we may be able to point you to a local signwriter, recharge your air-conditioning, or answer any queries about your vehicle. Whatever it may be, we're here for you.



**To find your nearest Van Centre, visit [www.volkswagen-vans.co.uk](http://www.volkswagen-vans.co.uk) or call 0800 717131**

# Prices

Every Amarok listed. All the prices you need

Want to work out how much your Amarok costs? Use our tracker on the back cover



Every Amarok comes with an On The Road package that covers your basic costs

On The Road (OTR) package	
First registration fee	£55.00
Delivery to Van Centre	£565.00
VAT	£117.00
Vehicle Excise Duty (12 months)	£215.00
Number plates	£20.00
Basic OTR (ex VAT)	£855.00
<b>Total OTR price</b>	<b>£972.00</b>

# Amarok

	Basic (ex VAT)	Total (inc VAT)	Total RRP including OTR*		Insurance group †
			(ex VAT)	(inc VAT)	
<b>Startline</b>					
2.0TDI 140PS 4MOTION® Selectable	£19,365.00	£23,238.00	£20,220.00	£24,210.00	TBC
2.0BiTDI 180PS 4MOTION® Selectable	£20,115.00	£24,138.00	£20,970.00	£25,110.00	9E
<b>Trendline</b>					
2.0BiTDI 180PS 4MOTION® Selectable	£21,115.00	£25,338.00	£21,970.00	£26,310.00	9E
<b>Highline</b>					
2.0BiTDI 180PS 4MOTION® Selectable	£23,695.00	£28,434.00	£24,550.00	£29,406.00	9E
2.0BiTDI 180PS 4MOTION® Permanent BlueMotion Technology	£24,025.00	£28,830.00	£24,880.00	£29,802.00	9E
2.0BiTDI 180PS 4MOTION® Permanent Auto BlueMotion Technology	£25,425.00	£30,510.00	£26,280.00	£31,482.00	10E

† As advised by the Association of British Insurers (ABI). Please see [www.thatcham.org/abigrouprating](http://www.thatcham.org/abigrouprating) for more information



Finance that makes buying a Volkswagen even more affordable

Thanks to our extensive range of finance packages, you may be surprised at how much you can afford. Make driving a Volkswagen a reality by speaking to us today.

  To find the nearest Van Centre to you, call us on 0800 717131 or visit [www.volkswagen-vans.co.uk](http://www.volkswagen-vans.co.uk)

# Options

Get the best from your Amarok with our quality options

ways to get even more from your Amarok



## Audio, phone and sat-nav

Even though the Amarok can take you away from the hustle and bustle of life, you can stay entertained, connected and on the right route with the RNS 315 sat-nav unit. It has a 5" touch-screen for easy use, as well as an aux-in for external devices.

p32



## Alloy wheels

Give your Amarok even more kerbside appeal with one of our stylish optional alloy wheel packages. The 10-spoke 18" Durban wheels (left) add extra flair, while the range-topping 19" Cantera wheels give your Amarok an even greater presence on the road.

p31

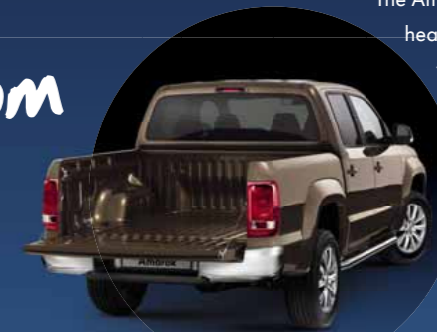

## Body and chassis

The Amarok's rear load bay is designed with heavy-duty cargo in mind, and can be fitted with an optional chemical- and UV-resistant coating for added protection. We've also got underbody protection packs if you're heading off the beaten track.

p33

## Comfort

Driving a rugged pick-up doesn't mean you have to compromise on luxury. Heated seats make your journey even more comfortable and you can even specify a leather multi-function steering wheel for added style.

p34



## Safety and security

Driving your Amarok in town can pose just as many dangers as the great outdoors, so why not choose the option of parking sensors or fog lights with a cornering function to avoid the pitfalls of urban life?

p36





## Options: Paint

You want your Amarok to make an impression. The most striking way to do that is to opt for a distinctive paint finish

		Startline		Trendline		Highline	
		Basic (ex VAT)	Total RRP (inc VAT)	Basic (ex VAT)	Total RRP (inc VAT)	Basic (ex VAT)	Total RRP (inc VAT)
<b>Standard</b> A choice of two great colours, available at no extra cost		S	S	S	S	S	S
<b>Metallic paints</b> Mark your Amarok out from the competition with a smart metallic paint finish		£450.00	£540.00	£450.00	£540.00	£450.00	£540.00
<b>Pearlescent paints</b> Tiny flecks of material in the paint reflect light, giving your Amarok a unique look		£450.00	£540.00	£450.00	£540.00	£450.00	£540.00

## Options: Alloy wheels

Complete your Amarok's sleek, sharp look with a set of stylish alloy wheels

		Startline		Trendline		Highline	
		Basic (ex VAT)	Total RRP (inc VAT)	Basic (ex VAT)	Total RRP (inc VAT)	Basic (ex VAT)	Total RRP (inc VAT)
<b>16" Taruma</b> Set of four 6.5J x 16 alloys with alloy spare and 245/70 R16 tyres		S	S	-	-	-	-
<b>17" Aldo</b> Set of four 8J x 17 alloys with alloy spare and 245/65 R17 tyres		-	-	S	S	-	-
<b>18" Durban</b> Set of four 7.5J x 18 alloys with steel spare and 255/60 R18 tyres		-	-	£400.00	£480.00	S	S
<b>19" Cantera</b> Set of four 8J x 19 alloys with alloy spare and 255/55 R19 tyres		-	-	£775.00	£930.00	£375.00	£450.00
<b>Spare wheel – alloy</b>		£195.00	£234.00	£195.00	£234.00	£195.00	£234.00



### Keep your alloys in perfect condition

Brake dust is full of abrasive and corrosive metal and carbon particles, so clean your alloys every couple of weeks with a specialist brush and cleaning fluid, then coat them with a wax protector. You can buy these at your local Van Centre.

### Add Ons



Accessories to help keep your vehicle 100% Volkswagen

If you want even more choice for alloy wheels, check out our Add Ons accessories. See page 38 for the full Amarok range or ask your local Van Centre for details. Call 0800 717131 or visit [www.volkswagen-vans.co.uk](http://www.volkswagen-vans.co.uk) to find the nearest Van Centre to you.



## Options: Audio, phone and satellite-navigation

Choose from a range of entertainment systems for great music on the go, or opt for one of our touch-screen satellite-navigation systems

			Startline		Trendline		Highline	
			Basic (ex VAT)	Total RRP (inc VAT)	Basic (ex VAT)	Total RRP (inc VAT)	Basic (ex VAT)	Total RRP (inc VAT)
<b>Audio</b>								
<b>RCD 210</b>		A great basic system for music on the go. Listen to the radio or play your own music on the CD player						
		<ul style="list-style-type: none"> <li>✓ Two speakers</li> <li>✓ FM/AM radio</li> <li>✓ Single CD player</li> </ul>	S	S	–	–	–	–
<b>RCD 310</b>		This radio includes four additional speakers and a CD player						
		<ul style="list-style-type: none"> <li>✓ Six speakers</li> <li>✓ FM/AM radio</li> <li>✓ Single CD player</li> </ul>	£125.00	£150.00	S	S	S	S
<b>Satellite-navigation</b>								
<b>RNS 315</b>		A great sat-nav to help you get where you're going efficiently. It includes RDS (Radio Data System) for live traffic updates, Bluetooth connectivity, an aux-in and an SD card slot, as well as western Europe mapping data pre-loaded on 4GB flash memory						
		<ul style="list-style-type: none"> <li>✓ 5" colour touch-screen</li> <li>✓ Four speakers</li> <li>✓ FM/AM radio with RDS</li> <li>✓ Single CD player</li> <li>✓ Aux-in for external devices</li> <li>✓ SD card reader</li> <li>✓ Bluetooth® connectivity</li> </ul>	£565.00	£678.00	£565.00	£678.00	£565.00	£678.00
<b>Phone</b>								
<b>BLUETOOTH CONNECTIVITY</b>		Go hands-free with compatible phones. This system includes a multi-function display.						
	(Not compatible with satellite navigation)		£200.00	£240.00	£200.00	£240.00	£200.00	£240.00

## Options: Body, chassis and windows

Tailor your Amarok to your needs with our body and chassis options, including towbars, underbody protection packs and mud flaps

			Startline		Trendline		Highline	
			Basic (ex VAT)	Total RRP (inc VAT)	Basic (ex VAT)	Total RRP (inc VAT)	Basic (ex VAT)	Total RRP (inc VAT)
<b>Towing</b>								
<b>Fixed ball with electrics</b>			£225.00	£270.00	£225.00	£270.00	£225.00	£270.00
<b>Mud flaps</b>								
<b>Mud flaps – front and rear</b>			£100.00	£120.00	£100.00	£120.00	£100.00	£120.00
<b>Cargo bay</b>								
<b>Load compartment protective coating</b> Anthracite-coloured, UV-resistant protection against mechanical and chemical damage			£485.00	£582.00	£485.00	£582.00	£485.00	£582.00
<b>Rear window rack</b>			£170.00	£204.00	£170.00	£204.00	£170.00	£204.00
<b>Windows</b>								
<b>Rear privacy glass</b>			£195.00	£234.00	£195.00	£234.00	S	S



### Useful towing tips

- 1. Watch your weight**  
Make sure your trailer doesn't exceed your vehicle's maximum towing limit or its gross train weight. You'll find these in your handbook.
- 2. Load well, stay stable**  
For stability, put heavy items low down over the trailer axle. Ensure the trailer has a slightly nose-down attitude, but that it doesn't exceed the van's or trailer's nose weight limit.
- 3. Check your tyres**  
Your van's tyres may need to be inflated to a greater pressure to cope with the extra load. Check your vehicle's handbook.

## Options: Comfort and convenience

From a multi-function steering wheel to various storage solutions, there's a range of features to make driving more comfortable

	Startline		Trendline		Highline	
	Basic (ex VAT)	Total RRP (inc VAT)	Basic (ex VAT)	Total RRP (inc VAT)	Basic (ex VAT)	Total RRP (inc VAT)
<b>Leather multi-function steering wheel</b>	£200.00	£240.00	£90.00	£108.00	£90.00	£108.00
<b>Cruise control and trip computer with multi-function display</b>	£150.00	£180.00	S	S	S	S
<b>Rain sensor and automatic dimming rear-view mirror</b>	£150.00	£180.00	£150.00	£180.00	£150.00	£180.00
<b>Heated front seats and heated washer nozzles</b>	£310.00	£372.00	£310.00	£372.00	S	S
<b>Centre console with cover</b>	£45.00	£54.00	S	S	S	S
<b>Rubber floor</b> In lieu of carpet	S	S	O	O	O	O
<b>Carpet floor</b> In lieu of rubber	O	O	S	S	S	S
<b>Non-smoking pack</b> Ashtray and lighter deleted	O	O	O	O	O	O



### Choose cruise control

Cruise control can help reduce the fatigue and stress of sticking to speed limits on long journeys. It also helps reduce the amount of fuel you use by cutting out the acceleration and braking used to keep up with road speed.

## Options: Seating, trim and upholstery

Improve the comfort of your Amarok with a selection of upholstery finishes

	Startline		Trendline		Highline	
	Basic (ex VAT)	Total RRP (inc VAT)	Basic (ex VAT)	Total RRP (inc VAT)	Basic (ex VAT)	Total RRP (inc VAT)
<b>Spacer cloth upholstery</b> Spacer cloth Grey/Anthracite (RW)	S	S	-	-	-	-
<b>Trail cloth upholstery</b> Trail cloth Anthracite (HV) / Trail cloth Buffalo (HG)	-	-	S	S	-	-
<b>Vienna leather upholstery</b> Seat material in contact with passengers is leather. Outer, sides and rear of seats are leatherette Vienna leather* Anthracite (HV) / Vienna leather* Mendoza (YC)	-	-	-	-	S	S
<b>Leatherette upholstery</b> Anthracite (HV)	£45.00	£54.00	-	-	-	-



### Pick the right upholstery

Cloth upholstery is terrifically hard-wearing, while leatherette upholstery is great for cleaning quickly and easily.

## Options: Safety and security

Beef up your Amarok's safety equipment with kit such as parking sensors, differential locks or first aid kits

	Startline		Trendline		Highline	
	Basic (ex VAT)	Total RRP (inc VAT)	Basic (ex VAT)	Total RRP (inc VAT)	Basic (ex VAT)	Total RRP (inc VAT)
<b>Parking aids</b>						
Parking sensors – rear only	£265.00	£318.00	–	–	–	–
Parking sensors – front and rear	–	–	£350.00	£420.00	S	S
<b>Lights</b>						
Front fog lights with cornering function	–	–	£60.00	£72.00	£60.00	£72.00
<b>Other safety and security options</b>						
Mechanical rear differential lock	S	S	£210.00	£252.00	£210.00	£252.00
First aid kit and warning triangle	£20.00	£24.00	£20.00	£24.00	£20.00	£24.00



### Useful security tips

#### 1. Get an alarm

Alarm noise may be enough to scare a thief and prevent a costly break-in.

#### 2. Lock your doors

Even if you're only away from your van for a minute, locked doors deter thieves looking for an easy target.

#### 3. Keep it tidy

Seemingly trivial items can still be bait to thieves. Stow gadgets out of sight or take them with you. Thieves know to look in the glove box, too.

#### 4. Load out of sight

Try and load your van in a secure location. Thieves can linger in public areas for an easy swipe-and-run.

#### 5. Park for visibility

Use well-lit areas. Avoid parking near vehicles or foliage that a thief could use for cover. Parking right up against walls can stop a thief getting in through your van's doors, too.

## Options: Heating, ventilation and electrical

Choose these heating, ventilation and electrical features to give your Amarok a functional and practical edge

	Startline		Trendline		Highline	
	Basic (ex VAT)	Total RRP (inc VAT)	Basic (ex VAT)	Total RRP (inc VAT)	Basic (ex VAT)	Total RRP (inc VAT)
Auxiliary water heater	£245.00	£294.00	£245.00	£294.00	£245.00	£294.00
Auxiliary water heater with programmable parking heater and radio remote control	£975.00	£1,170.00	£975.00	£1,170.00	£975.00	£1,170.00
Electrical interface for converters/coachbuilders to fit external devices	£45.00	£54.00	£45.00	£54.00	£45.00	£54.00
Tachograph preparation	£200.00	£240.00	£200.00	£240.00	£200.00	£240.00

**Add Ons**  
Accessories to help keep your vehicle 100% Volkswagen

*Want more?  
Pick an Add On...*

In addition to our factory-fit options, we've got a great range of Add Ons accessories to help you get even more out of your Amarok. You can choose alloys, side rails or leather seats for extra style, clever storage solutions for your interior, or rugged hardtops, tool boxes and tonneau covers for your cargo bay. Simply turn the page to find out more.

# Data

All the facts and figures you'll need for your vehicle

## Engines: Amarok

	2.0TDI 140PS	2.0BiTDI 180PS	2.0BiTDI 180PS Automatic
<b>ENGINE SPECIFICATIONS</b>			
Engine type	Diesel, water-cooled, in-line, variable-turbine-geometry turbocharger with intercooler	Diesel, water-cooled, in-line, bi-turbocharger with intercooler	
Mixture preparation/injection method	Common-rail, direct-injection		
EU exhaust emission standard	5		
Number of cylinders	4		
Cubic capacity	1,968cc		
Output, PS at rpm	140 at 3,750	180 at 4,000	180 at 4,000
Torque, max. Nm/rpm	340 at 1,750-2,250	400 at 1,500-2,000	420 at 1,750
Diesel Particulate Filter (DPF)	●	●	●
4MOTION® Selectable with heavy-duty suspension	●	●	–
4MOTION® Permanent with heavy-duty suspension	–	–	●
4MOTION® Permanent with standard suspension	–	●	–

### ENGINE SIZES

Output, engine speed and torque

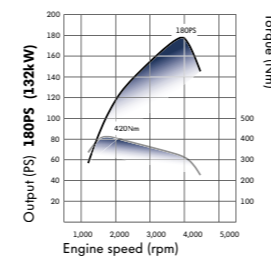
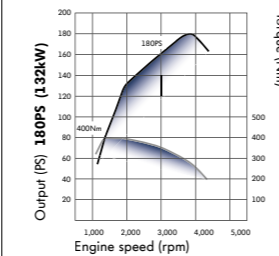
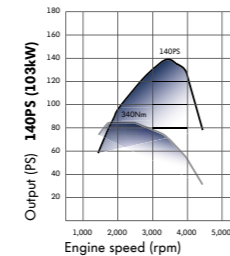

● Available.  
– Not available.

Output (PS)  
Torque (Nm)

## Standard features: Amarok

### Startline

#### EXTERIOR

16" x 6.5J Taruma alloy wheels fitted with 245/70 R16 tyres including tyre mobility system  
Door mirrors – electrically adjustable and heated  
80-litre fuel tank  
Body-coloured front bumper  
Black painted rear bumper with integrated step  
Black plastic door mirrors and handles  
Trailer hitch preparation  
Load compartment light  
Easy-to-use lockable tailgate

#### INTERIOR

Electric front and rear windows  
Climatic – semi-automatic air-conditioning system  
Three-seat rear bench, folding with ISOFIX points in outer seats  
RCD 210 single CD/radio with two speakers  
'Spacer' cloth upholstery  
12V socket in centre console  
Rubber flooring in cab  
Grab handle on A-pillar (passenger side only)

#### SAFETY AND SECURITY

Mechanical rear differential lock (Startline models only)  
4MOTION® Selectable – choose between rear-wheel drive, four-wheel drive and four-wheel drive with low range via a dash-mounted button (not on Highline 4MOTION® Permanent models)  
Heavy duty suspension – 3 + 2 leaf-spring system (not applicable to Highline 4MOTION® Permanent manual)  
Airbags – driver, front passenger (including de-activation switch) and front side/head on both front seats  
Remote central locking with interior locking switch and two remote folding keys  
Four lashing rings in load compartment  
Thatcham Category 1 alarm and immobiliser  
Electronic Stability Programme (ESP)  
Anti-lock Braking System (ABS) with Off-road ABS  
Anti-Slip Regulation (ASR)  
Electronic Differential Lock (EDL)  
Trailer stabilisation  
Hill Start and Hill Decent Assist  
Tool kit  
Emergency stop signal

### Trendline

#### IN ADDITION TO STARTLINE

17" x 8J Aldo alloy wheels with 245/65 R17 tyres including tyre mobility system  
Cruise control  
Trip computer with multi-function display including chrome detailing in instrument cluster  
Climatronic – two-zone automatic air-conditioning system  
RCD 310 single CD/radio with six speakers  
Leather steering wheel, gear knob and hand-brake handle  
Silver inlay around gear-shift console  
Front centre armrest  
'Trail' cloth upholstery  
Three 12V sockets – dash, centre console and load compartment  
Body-coloured door mirrors and handles, wheel arch extensions and front bumper, including chrome detailing in upper grille  
Storage drawers under front seats  
Front fog lights  
Carpet flooring in cab  
Grab handles on A- and B-pillars on driver and passenger sides  
Two multi-use mounting points. Several attachments are available as Accessories, including a cupholder, note clip and magnet. Please ask your Van Centre for details  
Silver interior door handles

### Highline

#### IN ADDITION TO TRENDLINE

18" x 7.5J Durban alloy wheels with 255/60 R18 tyres including tyre mobility system  
Privacy glass  
'Vienna' leather upholstery: seat material in contact with passengers is leather, other areas are leatherette  
Heated front seats  
Dimmable dashboard illumination  
Chrome rear bumper with integrated step  
Chrome / body-coloured door mirrors  
Body-coloured front bumper, including chrome detailing in lower and upper grille  
Polished-stainless-steel side bars  
Parking sensors – front and rear  
Standard suspension – 2 + 1 leaf-spring system (4MOTION® Permanent manual model only)  
4MOTION® Permanent (4MOTION® Permanent models only)

### BlueMotion Technology

#### IN ADDITION TO HIGHLINE

Low rolling resistance tyres  
Start/stop system  
Regenerative braking  
BlueMotion Technology exterior badge

## Dimensions and weights: **Amarok**

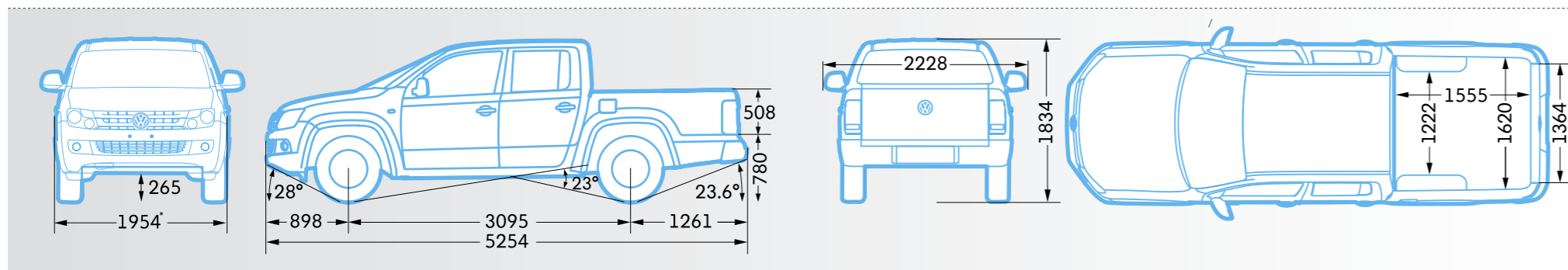

Dimensions	
Wheelbase	3,095
Length	5,254
Width	1954*
Height	1,834
Ground Clearance	265
Wade depth	500
<b>Load Area</b>	2.52m <sup>2</sup>
<b>Tailgate dimensions</b>	
Width	1,364
Height	508
<b>Turning circle</b> (wall to wall)	12.95m

Model/engine/transmission	Gross vehicle weight (kg)	Axle load limit front/rear (kg)	Trailer weight braked 12%/unbraked (kg)	Gross train weight (kg)	Unladen weight † (kg)	Payload † (kg)
<b>STARTLINE</b>						
2.0TDI 140PS 4MOTION® Selectable	3,170	1,390/1,860	3,000/750	5,550	2,025	<b>1,145</b>
2.0BiTDI 180PS 4MOTION® Selectable	3,170	1,410/1,860	3,000/750	5,550	2,025	<b>1,145</b>
<b>TRENDLINE</b>						
2.0BiTDI 180PS 4MOTION® Selectable	3,170	1,410/1,860	3,000/750	5,550	2,058	<b>1,112</b>
<b>HIGHLINE</b>						
2.0BiTDI 180PS 4MOTION® Selectable	3,170	1,410/1,860	3,000/750	5,550	2,079	<b>1,091</b>
2.0BiTDI 180PS 4MOTION® Permanent BlueMotion Technology	2,820	1,385/1,620	3,000/750	5,950	2,048	<b>772</b>
2.0BiTDI 180PS 4MOTION® Permanent Auto BlueMotion Technology	3,170	1,425/1,860	3,200/750	5,950	2,093	<b>1,077</b>

Dimensions in mm unless otherwise indicated.

\*Startline models are 10mm narrower (1944mm) than Trendline and Highline models

† Unladen weight and payload figures are calculated with 100% fuel load and no driver.

The published payload figure is based on a standard-specification vehicle. It does not include any items of optional equipment. Any optional equipment will reduce the payload from the published figure and impact on the axle load limits. Care must be taken to ensure the vehicle is not overloaded and, in this regard, customers should consider the weight of any optional equipment when calculating axle loads

## Economy and performance: **Amarok**

Model/engine/transmission	Urban mpg (l/100km) <sup>1</sup>	Extra-urban mpg (l/100km) <sup>1</sup>	Combined mpg (l/100km) <sup>2</sup>	Acceleration 0-62 mph (seconds)	Top speed mph (where law permits)	CO <sub>2</sub> emissions (g/km) <sup>1</sup>
<b>STARTLINE</b>						
2.0TDI 140PS 4MOTION® Selectable	29.4 (9.6)	41.5 (6.8)	<b>36.2 (7.8)</b>	13.5	101	<b>205</b>
2.0BiTDI 180PS 4MOTION® Selectable	30.7 (9.2)	38.7 (7.3)	<b>35.3 (8.0)</b>	11.0	111	<b>211</b>
<b>TRENDLINE</b>						
2.0BiTDI 180PS 4MOTION® Selectable	30.7 (9.2)	38.7 (7.3)	<b>35.3 (8.0)</b>	11.0	111	<b>211</b>
<b>HIGHLINE</b>						
2.0BiTDI 180PS 4MOTION® Selectable	30.7 (9.2)	38.7 (7.3)	<b>35.3 (8.0)</b>	11.0	111	<b>211</b>
2.0BiTDI 180PS 4MOTION® Permanent BlueMotion Technology	32.8 (8.6)	39.8 (7.1)	<b>37.2 (7.6)</b>	11.0	111	<b>199</b>
2.0BiTDI 180PS 4MOTION® Permanent Auto BlueMotion Technology	31.0 (9.1)	38.2 (7.4)	<b>35.3 (8.0)</b>	11.3	108	<b>211</b>

<sup>1</sup>The fuel consumption and emission test values shown are in full compliance of the fuel consumption directive 80/1268/EWG

# Notes

Lined area for taking notes, consisting of horizontal dotted lines.

# Keep track of your costs

The vehicle <small>(see pages 10-23)</small>	Basic price (ex VAT)	Total RRP (inc VAT)
Model (eg: Amarok Startline 2.0BitDI 180PS 4MOTION® Selectable)		
<b>Base model total</b>	£	£

Options <small>(see pages 29-37)</small>		
Factory-fit options (eg: alloy wheels, sat-nav etc.)		
<b>Options total</b>	£	£

Add Ons <small>(see pages 38-44)</small>		
You can add any item from our Add Ons accessories range when you buy your vehicle.		
<b>Add Ons total</b>	£	£

<b>Grand total</b>	£	£
--------------------	---	---

## The small print and the footnotes

Print processes do not allow exact reproduction of the paint and upholstery colours. Some of the vehicles shown are fitted with optional equipment at extra charge.

All data given and specifications are in accordance with information available at the time of going to print and are subject to change without notice. Vehicles not in current UK stock and customer order vehicles may take a number of weeks for delivery. Certain combinations of vehicle specifications and factory-fitted extras are not compatible and therefore all orders received are subject to confirmation. Models, factory-fitted options and paint and upholstery options subject to availability. Please check details and availability with an appropriate authorised Volkswagen Van Centre at the time of ordering.

Volkswagen Commercial Vehicle Finance is a trading name of Volkswagen Financial Services (UK) Limited. Finance subject to status, and available to over 18s only.

Full details of Volkswagen warranties are available from your authorised Volkswagen Van Centre or Van Service Centre.

Volkswagen Commercial Vehicle Insurance is a trading name of Volkswagen Insurance Service (Great Britain) Limited, an appointed representative of Volkswagen Financial Services (UK) Limited, Brunswick Court, Yeomans Drive, Blakelands, Milton Keynes MK14 5LR. Registered in England number 2835230. Volkswagen Commercial Vehicle Insurance is sold, underwritten and administered by Allianz Insurance plc registered in England number 84638. Registered office 57 Ladymead, Guildford, Surrey GU1 1DB. Volkswagen Financial Services (UK) Limited and Allianz Insurance plc are authorised and regulated by the Financial Services Authority. Volkswagen Financial Services (UK) Limited and Allianz Insurance plc are not part of the same corporate group

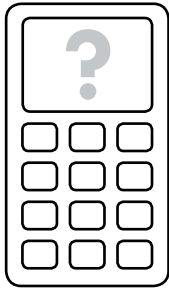

# Work out how much it costs

*Turn over to keep track of the prices of the vehicle and options you're choosing. Then take this page into your Van Centre.*

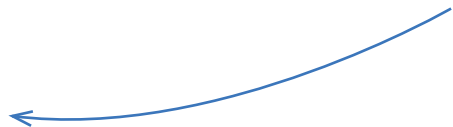

## Get in touch with the experts

To find your nearest Van Centre call

**0800 717131**

or visit [www.volkswagen-vans.co.uk](http://www.volkswagen-vans.co.uk)

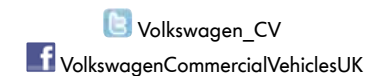

**Issue: January 2013**

Printed in the UK, 2 January 2013. CVW555AMK  
This brochure supersedes all previous publications