

May 2009



Commercial
Vehicles

The Sportline range



SPORTLINE



Caddy and Caddy Maxi Sportline. Stand out from the crowd.

A whole host of enhancements set both the Volkswagen Caddy Sportline and the Volkswagen Caddy Maxi Sportline apart from the crowd. Both models have the top-of-the-range 140PS diesel engine and a smooth 6-speed gearbox, providing huge power and workload capability.

The Caddy Sportline has a maximum payload of 677kg with a load space of 3.2m³, one side sliding door, and bulkhead with upper mesh panel whilst the Caddy Maxi Sportline carries a whopping 724kg payload in a cavernous 4.2m³ load space. It also boasts a sliding door on both sides, providing maximum flexibility in loading, and a full height solid bulkhead.

One glance will identify these models as a little bit special. Colour-coded bumpers, mirrors and door handles, lower front spoiler, rear roofline spoiler, integrated front fog lights, chrome front grilles and the bespoke 17" 6-spoke alloy wheels have a Sportline centre logo which all add to the sporty feel. The chrome side rails not only look good, they also protect the sills from damage. There's a choice of Tornado Red, Reflex Silver metallic or Diamond Black pearl paint finishes to complement your personality.



- 01** Superb sound from a RCD 300 Radio/CD player, MP3 compatible with 2 wideband speakers. Includes AUX-IN socket.
- 02** Stylish, bespoke Sportline badge.
- 03** Electric front windows.
- 04** Full height bulkhead – solid lower with plastic mesh upper on Caddy Sportline.
- 05** Sportline models can be specified in Tornado Red (or Reflex Silver metallic and Diamond Black pearl which are available at extra cost).

Caddy and Caddy Maxi Sportline. Be distinctive: elevate your profile.

The chrome side rails, colour-coded handles and alloy wheels make the Sportline distinctive. However, the all round exterior styling is only part of the package. The interior is a bit special too, with the seats being upholstered in premium grade, hand-crafted black Italian leather using red stitching, micro perforated centre panels and an exclusive embroidered Sportline logo.

But it is more than just the Sportline styling that makes these models a bit different. The driver's compartment is ergonomically laid out, and additional touches are easily apparent. Both models are equipped with 'Climatic' air conditioning, an RCD 300 radio/CD unit featuring an AUX-IN socket for connection to an external multimedia source such as MP3 player and iPod, and conveniently located controls for the electronic front windows and the electronically adjustable and heated mirrors.

Safety is paramount too, with ABS (Anti-lock Braking System), TCS (Traction Control System) and EBC (Engine Braking Control) all coming as standard. A driver's airbag is also fitted as well as all the appropriate safety measures you would expect from a Volkswagen Commercial Vehicle.

So when you need a good balance between work and pleasure, the Sportline range is the perfect choice.

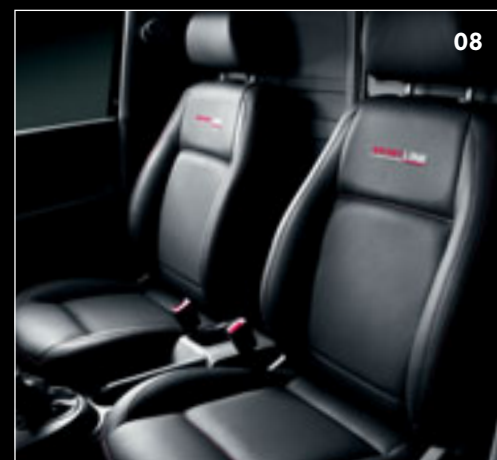

- 06** Opaque glass on rear doors of Caddy and Caddy Maxi Sportline, image also shows the rear roofline spoiler.
- 07** Elegant body-coloured front bumper with sporty lower front spoiler.
- 08** Sumptuous hand-crafted black Italian leather seats with perforated centre panels and embroidered Sportline logo.
- 09** 17" 6-spoke alloy wheels enhanced with Sportline centre caps.
- 10** Solid full height bulkhead on Caddy Maxi Sportline.

Caddy and Caddy Maxi Sportline standard specifications.

Body.

<ul style="list-style-type: none"> • Bumpers, body-coloured • Door handles, body-coloured • Exterior mirrors: <ul style="list-style-type: none"> - Aspherical on driver's side - Body-coloured - Convex on passenger's side - Electrically adjustable and heated 	<ul style="list-style-type: none"> • Fuel tank, lockable (60 litre capacity) • Glazed (opaque glass) asymmetric rear-wing doors • Heat reflective glass • Partially galvanised all-steel body • Roof load rack preparation • Tyre repair kit 	Items fitted by Volkswagen approved supplier¹: <ul style="list-style-type: none"> • Centre wheelcaps with Sportline decal • Chrome side rails • Lower front spoiler • Rear roofline spoiler • Sportline badge, rear • Upper and lower chrome grilles, front
--	--	---

Interior equipment.

Cab area: <ul style="list-style-type: none"> • 2 folding and pivoting sun visors • Driver's seat with height, reach and rake adjustment • Grab handles on roof frame • Interior light in headliner • Passenger seat with reach and rake adjustment • Rubber floor covering 	<ul style="list-style-type: none"> • Storage <ul style="list-style-type: none"> - 2 storage trays in dash panel - 4 drinks holders and storage compartment in centre console - Open glove compartment - Overhead storage 	Rear: <ul style="list-style-type: none"> • 2 door-activated interior lights • Half-height load side lining in painted hardboard • Interior roof trim in hardboard • Load sill protection • Sheet steel flooring
Item fitted by Volkswagen approved supplier¹: <ul style="list-style-type: none"> • Black and red leather upholstery with Sportline logo 		

Functional equipment.

<ul style="list-style-type: none"> • 12V socket • AUX-IN socket for connection to external multimedia source • 'Climatic' semi-automatic air conditioning • Digital clock • Dimmable dashboard illumination 	<ul style="list-style-type: none"> • Electric, heated exterior mirrors • Electric windows • Radio/single CD player, MP3 compatible with 2 wideband speakers • Remote central locking with deadlocks, internal locking switch and 1 remote key 	<ul style="list-style-type: none"> • Rev counter • Warning buzzer for lights left on • Windscreen wiper with variable intermittent delay and wash/wiper system
--	---	---

Running gear.

<ul style="list-style-type: none"> • Front and rear axle: <ul style="list-style-type: none"> - Anti-roll bars, front and rear - Front McPherson strut suspension - Rear rigid axle with single layer leaf springs - Telescopic shock absorbers 	<ul style="list-style-type: none"> • Hydraulic brake system with disc brakes and ABS: Anti-lock Braking System • Hydraulic Power steering 	Items fitted by Volkswagen approved supplier¹: <ul style="list-style-type: none"> • 17" 6-spoke alloy wheels • Tyres: 225/45/ZR17 94 Y
--	---	--

Safety and security equipment.

<ul style="list-style-type: none"> • 3rd brake light • ABS: Anti-lock Braking System • Breaksafe steering wheel lock • Driver's airbag • EBC: Engine Braking Control • EBD: Electronic Brakeforce Distribution 	<ul style="list-style-type: none"> • Electronic Immobiliser 'Transponder' • Front fog lights • Halogen main headlights with range control • Height adjustable head restraints • Height and rake adjustable safety steering column 	<ul style="list-style-type: none"> • Load lashing rings (6) • Rear fog lights • Rear-view mirror with anti-dazzle function • TCS: Traction Control System • Three-point, height adjustable and tensioning inertia reel seat belts
--	--	--

Model specific features.

Caddy Sportline specific equipment.

<ul style="list-style-type: none"> • Full height bulkhead - solid lower and plastic mesh upper 	<ul style="list-style-type: none"> • Side sliding door on left
---	---

Caddy Maxi Sportline specific equipment.

<ul style="list-style-type: none"> • Full height bulkhead - solid 	<ul style="list-style-type: none"> • Side sliding doors on left and right
--	--

Engine, fuel consumption and performance.

Engine and transmission.	140PS TDI PD 2.0 litre
Engine type	Transverse, water cooled in line variable geometry turbocharger with intercooler
No. of cylinders	4
Cubic capacity, cm ³	1,968
Mixture preparation/injection method	Unit injector pump direct injection
Diesel particulate filter	s
Output, PS at rpm	140 at 4,000
Torque, max. Nm/rpm	320/1,800 – 2,500
EU exhaust emission standard	EU 4
6-speed manual gearbox	Front wheel drive
Alternator	110A
Battery	61Ah (330A)

140PS
output (PS)
torque (Nm)
engine speed (rpm)

Model	Engine	Urban* mpg (l/100km)	Extra urban* mpg (l/100km)	Combined* mpg (l/100km)	Acceleration 0-62 mph	Top speed (where the law permits) mph
-------	--------	-------------------------	-------------------------------	----------------------------	--------------------------	---

Fuel consumption and performance.

Caddy Sportline	140PS TDI PD	2.0l	36.7 (7.7)	52.3 (5.4)	45.6 (6.2)	10.1	116
Caddy Maxi Sportline	140PS TDI PD	2.0l	36.7 (7.7)	52.3 (5.4)	45.6 (6.2)	10.5	116

¹ Items fitted in UK by a Volkswagen approved supplier, please refer to page 27 for details.

s Standard

* With 50% payload.

Recommended retail prices and options list.

Model	Manufacturer's recommended retail prices				Ins. group**	
	Basic retail excluding VAT £ †	VAT £ †	Total retail including VAT £ †	Total retail including OTR* excluding VAT £ †		
Caddy Sportline panel van.						
140PS TDI PD	17,200.00	2,580.00	19,780.00	18,010.00	20,675.50	5E-T2
Caddy Maxi Sportline panel van.						
140PS TDI PD	18,480.00	2,772.00	21,252.00	19,290.00	22,147.50	5E-T2

*OTR (on the road) package includes the following:
 Delivery to retailer £550.00
 Number plates £20.00
 VAT £85.50
 Road fund licence £185.00
 First registration fee £55.00
Total £895.50

	Manufacturer's recommended retail prices		
	Basic retail excluding VAT £ †	VAT £ †	Total retail including VAT £ †
Paint options.			
Metallic and pearl paint ¹	305.00	45.75	350.75

† Calculated at 15% on all products.

** As advised by the Association of British Insurers (ABI). Please see www.abi.org.uk/carinsurance for more information.

Paint colours and upholstery.

Solid paint.

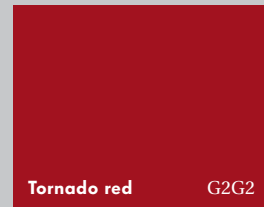

Metallic paint¹



Pearl effect paint¹



Upholstery.

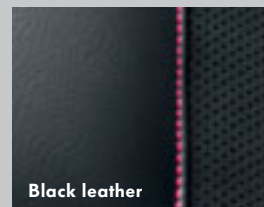

Please note: Print processes do not allow exact reproduction of the paint and upholstery colours.

¹ Metallic and pearl effect paints are available at extra cost.

Weights and dimensions.

Caddy Sportline panel van dimensions.

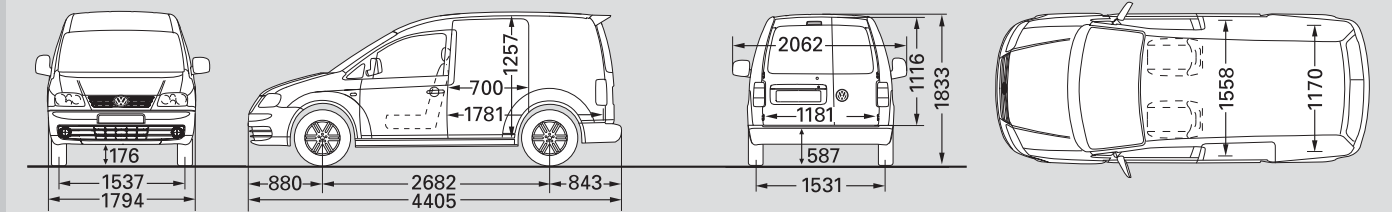

Load compartment:	Width (between wheel housings)	1,170	
1,781 (l) x 1,558 (w) x 1,257 (h)	Lateral sliding door:	700 (w) x 1,108 (h)	
Volume	3.2m ³	Rear doors:	1,181 (w) x 1,116 (h)
	Turning circle (wall to wall)	11.1m	Dimensions in mm unless otherwise indicated.

Caddy Maxi Sportline panel van dimensions.

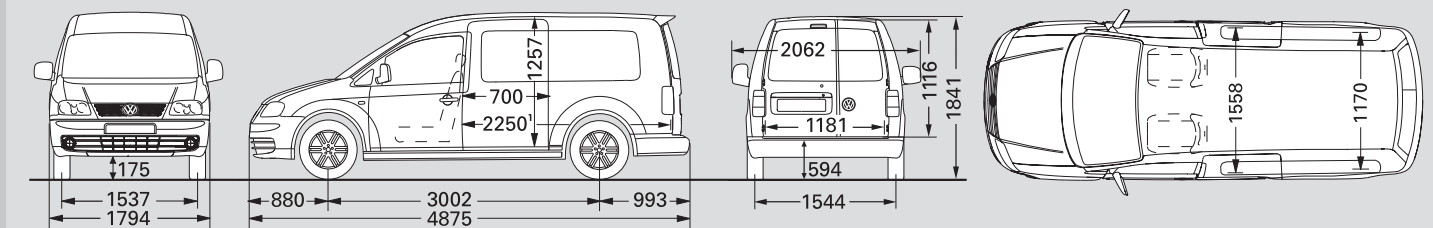

Load compartment:	Width (between wheel housings)	1,170	
2,250 (l) x 1,558 (w) x 1,257 (h)	Lateral sliding doors:	700 (w) x 1,108 (h)	
Volume	4.2m ³	Rear doors:	1,181 (w) x 1,116 (h)
	Turning circle (wall to wall)	12.2m	Dimensions in mm unless otherwise indicated.

Wheelbase	Engine	Gross vehicle weight kg	Axle load limit front / rear kg	Trailer weight braked / unbraked* kg	Gross train weight kg	Unladen weight** kg	Payload*** kg
Weights.							
Caddy	140PS TDI PD	2,222	1,075 / 1,230	1,500 / 740	3,500	1,545	677
Caddy Maxi	140PS TDI PD	2,342	1,165 / 1,300	1,500 / 750	3,500	1,618	724

The payload includes the driver at 75kg. Actual weights may vary by model specification.

Roof load limit: Caddy Sportline and Caddy Maxi Sportline 100kg.

Trailer nose weight limit: Caddy Sportline and Caddy Maxi Sportline 80kg.

* For 12% gradient.

The height measurements listed here may vary by ± 50mm depending on equipment fitted.

Weights are for vehicles with standard specification. The addition of factory options or Volkswagen Van Centre fitted accessories may affect unladen weight and payload.



The Transporter Sportline. Working hard never looked so good.

The Transporter Sportline range is designed to complement your lifestyle. These exciting models combine desirability and practicality with the performance of a very capable 174PS diesel engine.

Distinctive styling sets the Transporter Sportline range apart. To the rear, a roof spoiler, painted bumpers and a unique badge set the tone. In profile, the visual impact of the chrome side rails becomes apparent whilst also affording a degree of protection against sill damage. A purposeful stance is created with the aid of 30mm reduced suspension springs and 18" special weight-rated alloy wheels and all weather tyres. Body coloured door handles and mirrors also complement the distinctive styling.

Transporter Sportline models arguably have the most powerful impact when viewed from the front. Painted bumpers, a lower spoiler with integrated fog lights and chrome upper and lower grilles give the vehicles commanding road presence.



- 01** Standard Radio/CD player and manually controlled air conditioning.
- 02** Stylish, bespoke Sportline badge.
- 03** Deep storage pockets in front driver and passenger doors.
- 04** Electric windows and electrically adjustable, heated mirror controls.
- 05** Handy storage netting is located under the dash on the passenger side.

Available in three distinctive colours – Diamond Black pearl, Reflex Silver metallic and Tornado Red – the Transporter Sportline range is based on the Transporter T30 and is available as a panel van in either short or long wheelbase or as a short wheelbase kombi. The 174PS TDI engine uses the highly acclaimed PD (Pumpe Duese) diesel technology and develops a hugely impressive 400Nm of torque at 2,000rpm. Coupled with a 6-speed manual gearbox, it is the most powerful diesel engine in the Volkswagen Commercial Vehicles range.

Safety is also key, with ABS (Anti-lock Braking System), TCS (Traction Control System) and EBC (Engine Braking Control) all coming as standard. A driver's airbag is also fitted as standard, as well as 3-point inertia reel seat belts on all seats to further emphasise that the desirability, practicality and performance of the Sportline range is backed up with the appropriate safety measures.

From the inside, Transporter Sportline models offer a well thought out, ergonomic cab. The interior provides a commanding driving position, and standard features such as height and reach adjustable driver's seat and steering column enable you to create the ideal driving environment. Air conditioning is also fitted as standard to help maintain the desired temperature inside the vehicle. The Transporter Sportline panel van and kombi boast plenty of storage areas for the oddments that you carry with you.

Comfort is also of paramount importance, which is why a comfort seat with armrests for the driver comes as standard. To further enhance an already well-appointed interior, all seats are upholstered in hand-crafted premium grade black Italian leather with micro perforated centre panels, silver stitching and an exclusive Sportline logo embroidered on the seat backrests. In addition, electric front windows and heated, adjustable door mirrors are fitted as standard with conveniently located controls.



06

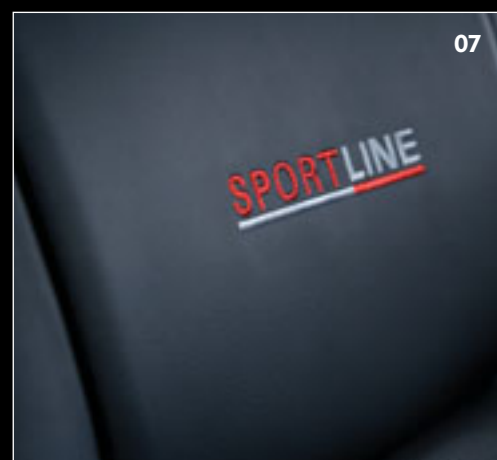

07

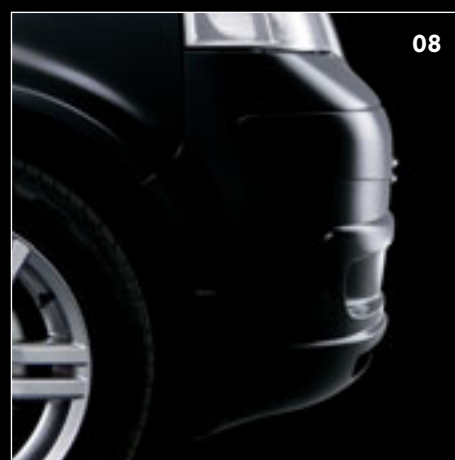

08

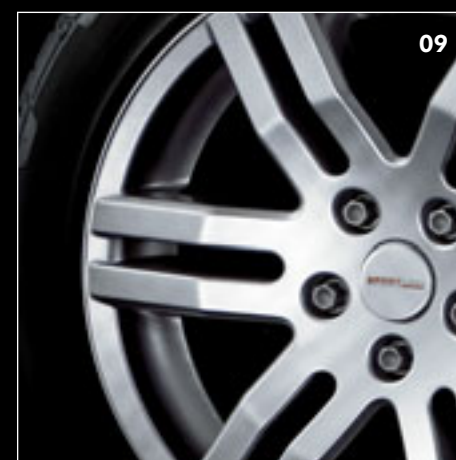

09



10

- 06** Remote central locking with deadlocks and internal locking button (1 fixed and 1 folding remote key).
- 07** Hand crafted leather with embroidered Sportline logo.
- 08** Stylish painted bumper with front spoiler.
- 09** 18" alloy wheel sporting the Sportline centre caps.
- 10** Sportline models can be specified in Tornado Red (or Reflex Silver metallic and Diamond Black pearl which are available at extra cost).

The Transporter Sportline panel van. Demands respect.

The Transporter Sportline panel van will certainly make a statement about you, your business and your lifestyle. The sport styling and purposeful stance sets the Transporter Sportline panel van apart from the crowd. Backed by a powerful 174PS TDI PD diesel engine to match its stunning looks. And the interior doesn't disappoint, with a luxurious specification, ergonomic dash layout plus a dual passenger seat.

Available in two wheelbase lengths, the Transporter Sportline panel van boasts a load volume of up to 6.7m³ which will carry the tools of your trade as well as the everyday essentials with ease. Access to the rear load compartment is gained through a wide side sliding door and the twin rear doors. A tailgate can be specified as an optional extra. It's a natural choice for those who want to make their presence felt.

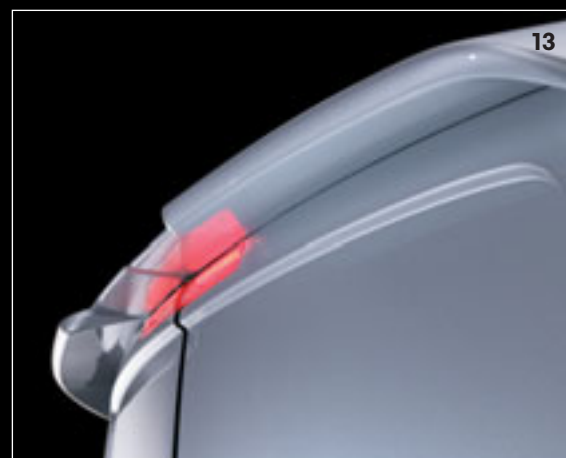
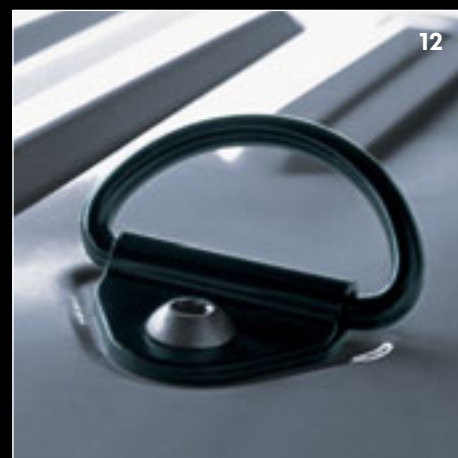
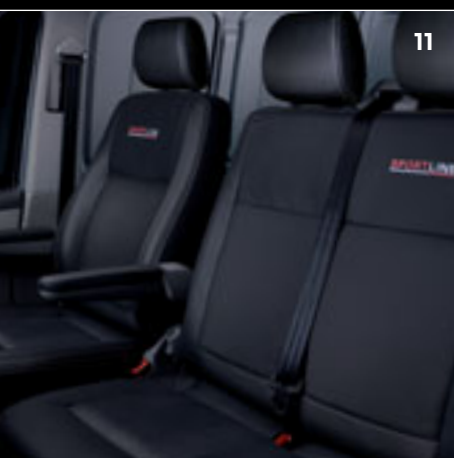

- 11** Driver's comfort seat with armrests and dual passenger seat trimmed in Sportline leather.
- 12** 6 load lashing rings in load compartment on SWB, 8 on LWB.
- 13** Rear roofline spoiler, image shows spoiler fitted to rear wing doors. Optional tailgate available.
- 14** Panel van load area with sheet steel flooring, note how the spoiler splits when the rear doors are opened.

The Transporter Sportline kombi. Flexibility with style.

When your lifestyle demands that you need to carry passengers as well as the tools of your trade, the Sportline kombi becomes the essential addition to the family. With the same distinctive styling plus a single passenger seat with reach and rake adjustment and a 3-seat bench in the first rear row, the Sportline kombi can carry up to four passengers plus the driver with ease.

With all the available storage compartments and temperature controlled environment it's a great place for your passengers as well the driver. The rear passenger compartment is well ventilated with side windows that slide open on both sides of the vehicle. The standard tailgate has heated rear window with wash/wipe. All this adds to the comfort for passengers on long journeys so that you arrive refreshed and relaxed.



15



16



17



18

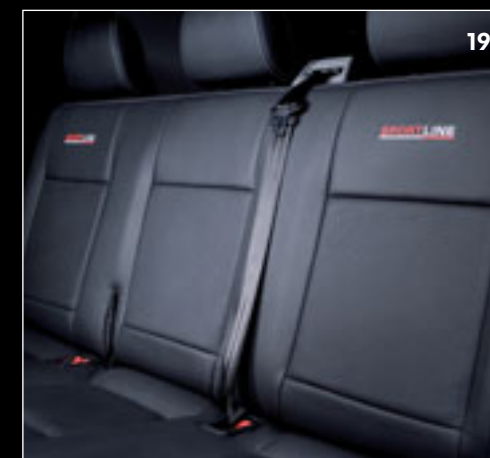

19

- 15 The rear of the driver and passenger seats have useful storage pockets.
- 16 Tailgate with heated rear window and wash/wipe.
- 17 Sliding windows in side door and opposite.
- 18 Stylish leather trimmed interior panels in rear compartment.
- 19 1st rear row 3-seat bench upholstered in premium grade Italian black leather with embroidered Sportline logo.

Transporter Sportline standard specifications.

Body.		
<ul style="list-style-type: none"> • 2 front doors • 8 securing points for roof load rack system • Bumpers, body-coloured • Covered sliding door guide • Door handles, body-coloured • Exterior mirrors: <ul style="list-style-type: none"> - Body-coloured - Convex on passenger's side - Spherical with outer wide angle section on driver's side 	<ul style="list-style-type: none"> • Fuel tank, lockable (80 litre capacity) • Heat reflective glass • Jack and tool kit • Self-supporting and galvanised full steel body • Towing eyes, front screw-in and rear fixed to body • Underbody made up of long and cross members 	Items fitted by Volkswagen approved supplier¹: <ul style="list-style-type: none"> • Centre wheel caps with Sportline decal • Chrome side rails • Lower front spoiler • Rear roofline spoiler • Sportline badge, rear • Upper and lower chrome grilles, front

Interior equipment.		
Cab area: <ul style="list-style-type: none"> • 2 storage compartments in dash panel beneath outer air vents • 2 storage compartments in driver's door, lower holds 1.5l bottle • 2 storage compartments in passenger door, lower holds 1l bottle • 2 sun visors, folding and pivoted • Coat hook • Dash mounted gear lever • Door panel trim – moulded plastic • Drinks holder • Driver's comfort seat with armrest, height, lumbar, reach and rake adjustment 	<ul style="list-style-type: none"> • Hook on lower dash on front passenger side • Interior entry steps • Interior light in headliner • Interior roof trim as headliner • Lockable glove compartment • Open storage compartment in dash panel including mobile phone holder • Rubber floor covering • Side roof frame trim • Storage box integrated in interior roof headliner • Storage net on lower dash passenger side 	Rear: <ul style="list-style-type: none"> • 2 interior lights switchable by doors • 6 load lashing rings on SWB • Interior entry step • Interior roof trim in grey painted hardboard • Rear door interior release lever • Side sliding door on left Item fitted by Volkswagen approved supplier¹: <ul style="list-style-type: none"> • Black leather upholstery with Sportline logo

Functional equipment.		
<ul style="list-style-type: none"> • 12V socket • Air conditioning, manually controlled • Electric, heated exterior mirrors • Electric windows • Heater and fresh air system with dust and pollen filter, 4-stage fresh air blower and air recirculation flap 	<ul style="list-style-type: none"> • Instrument panel includes: <ul style="list-style-type: none"> - Brake pad wear indicator - Coolant temperature display - Digital clock - Fuel gauge - Rev counter - Speedometer with total mileage and trip counter - Warning lamp for handbrake applied 	<ul style="list-style-type: none"> • Radio/in-dash CD player (2 DIN) with 2 speakers • Remote central locking with deadlocks and internal locking button (1 fixed and 1 folding remote key) • Warning buzzer for lights left on • Windscreen wiper with 2-speed operation, variable intermittent delay and wash/wiper system (including touch/sweep function)

Running gear.		
<ul style="list-style-type: none"> • Front and rear axle: <ul style="list-style-type: none"> - Anti-roll bars, front and rear - Front McPherson strut suspension - Independent suspension - Rear miniblock springs - Telescopic shock absorbers 	<ul style="list-style-type: none"> • Hydraulic brake system with ventilated disc brakes and ABS: Anti-lock Braking System • Power steering 	Items fitted by Volkswagen approved supplier¹: <ul style="list-style-type: none"> • 18" 6-spoke alloy wheels • 18" running gear • 30mm reduced suspension springs • Temporary steel spare wheel, limited to 50mph • Tyres: All weather 235/50 R18

Safety and security equipment.		
<ul style="list-style-type: none"> • 2 reversing lights • ABS: Anti-lock Braking System • Anti-theft protection: <ul style="list-style-type: none"> - Breaksafe steering wheel lock - Electronic immobiliser 'Transponder' • Driver and passenger airbags • EBC: Engine Braking Control (MSR) • EBD: Electronic Brakeforce Distribution 	<ul style="list-style-type: none"> • Fog lights, front • Fog light, rear • Halogen main headlights • Headlight range control • Head restraints, height adjustable • Safety steering column, height and rake adjustable 	<ul style="list-style-type: none"> • Seat belts, height adjustment and tensioners for all outer cab seats • Seat belts, three point inertia reel • Side mounted indicators • Single tone horn • TCS: Traction Control System

Model specific features.

Sportline panel van specific equipment.		
<ul style="list-style-type: none"> • 8 load lashing rings on LWB • Dual passenger seat, with storage box, folding seat backrest 	<ul style="list-style-type: none"> • Grey hardboard side lining (in load compartment) 	<ul style="list-style-type: none"> • Rear wing doors without windows • Sheet steel flooring (in load compartment)

Sportline kombi specific equipment.		
As panel van except: <ul style="list-style-type: none"> • 3-seater bench in 1st rear row, folding and tipping • Ashtray (in rear) • Childlocks (in rear) • Rubber floor covering (in rear) 	<ul style="list-style-type: none"> • Single passenger seat with reach and rake adjustment • Sliding windows in side door and opposite • Tailgate with heated rear window and wash/wipe 	Items fitted by Volkswagen approved supplier¹: <ul style="list-style-type: none"> • Leather trimmed interior panels in side door and opposite • Storage pockets on front seat back-rests

Engine, fuel consumption and performance.

Engine and transmission.	174PS TDI PD 2.5 litre
Engine type	Transverse, water cooled in line variable turbine geometry turbocharger with intercooler
No. of cylinders	5
Cubic capacity, cm ³	2,460
Mixture preparation/injection method	Unit injector pump direct injection
Diesel particulate filter	s
Output, PS at rpm	174 at 3,500
Torque, max. Nm/rpm	400/2,000
EU exhaust emission standard	EU 4
6-speed manual gearbox	Front wheel drive
Alternator	150A
Battery	72Ah (380A)

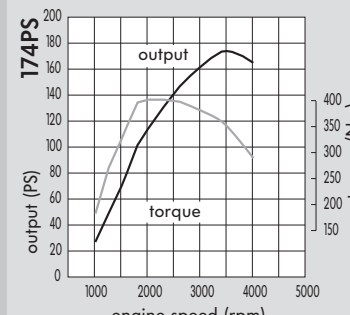

Model	Engine	Constant 56mph* (90km/h) mpg (l/100km)	Acceleration 0-62 mph	Top speed (where the law permits) mph
-------	--------	--	-----------------------	---------------------------------------

Fuel consumption and performance.				
panel van and kombi	174PS TDI PD	44.8 (6.3)	12.2	117

¹ Items fitted in UK by Volkswagen approved supplier, please refer to page 27 for details.

s Standard

* With 50% payload and 80 litre fuel tank capacity.

Recommended retail prices and options list.

Model	Manufacturer's recommended retail prices					Ins. group**	
	Basic retail excluding VAT £ †	VAT £ †	Total retail including VAT £ †	Total retail including OTR*			
Transporter Sportline T30 panel van.							
SWB	174PS TDI PD	24,090.00	3,613.50	27,703.50	24,900.00	28,599.00	7E-T2
LWB	174PS TDI PD	24,570.00	3,685.50	28,255.50	25,380.00	29,151.00	7E-T2
Transporter Sportline T30 kombi.							
SWB	174PS TDI PD	25,830.00	3,874.50	29,704.50	26,640.00	30,600.00	7E-T2

*OTR (on the road) package includes the following:
 Delivery to retailer £550.00
 Number plates £20.00
 VAT £85.50
 Road fund licence £185.00
 First registration fee £55.00
Total £895.50

	Manufacturer's recommended retail prices		
	Basic retail excluding VAT £ †	VAT £ †	Total retail including VAT £ †
Paint options.			
Metallic and pearl paint ¹	475.00	71.25	546.25
Door and access options.			
Rear door pack B - tailgate without window (panel van only)	-120.00	-18.00	-138.00

† Calculated at 15% on all products.

** As advised by the Association of British Insurers (ABI). Please see www.abi.org.uk/carinsurance for more information.

Paint colours and upholstery.

Solid paint.

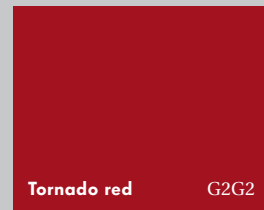

Metallic paint¹



Pearl effect paint¹



Upholstery.

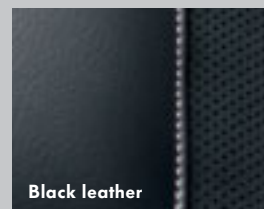

Please note: Print processes do not allow exact reproduction of the paint and upholstery colours.

¹ Metallic and pearl effect paints are available at extra cost.

Weights and dimensions.

Short wheelbase (3,000mm) panel van dimensions.

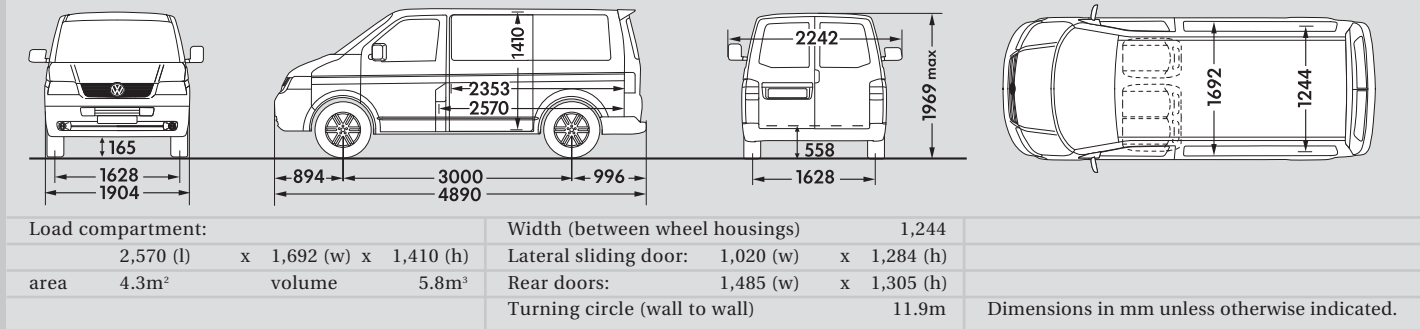

Long wheelbase (3,400mm) panel van dimensions.

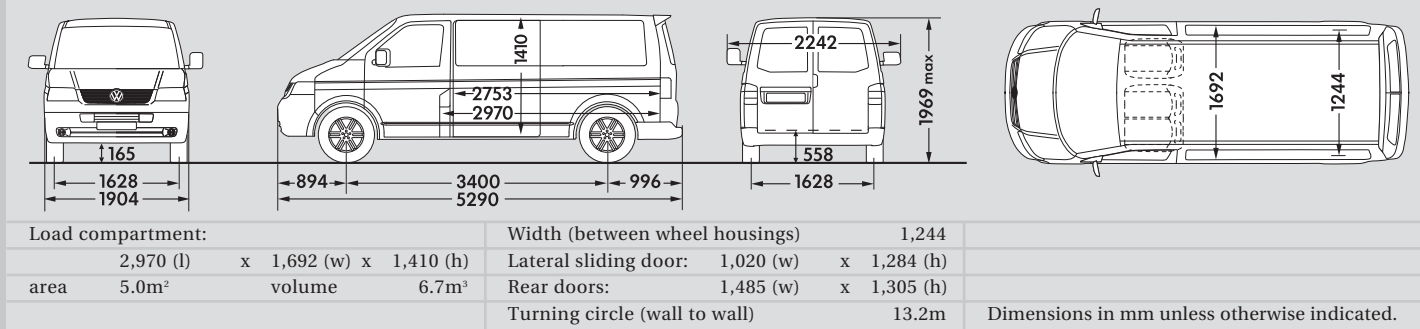

Short wheelbase (3,000mm) kombi dimensions.

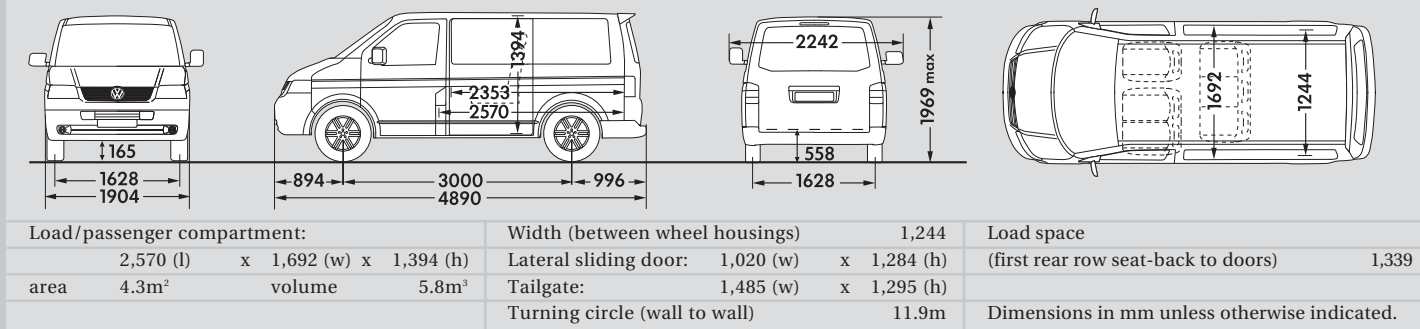

Wheelbase	Engine	Gross vehicle weight kg	Axle load limit front / rear kg	Trailer weight braked / unbraked* kg	Gross train weight kg	Unladen weight** kg	Payload*** kg
Weights.							
SWB panel van	174PS TDI PD	3,000	1,575 / 1,625	2,500 / 750	5,200	1,872	1,128
LWB panel van	174PS TDI PD	3,000	1,575 / 1,625	2,500 / 750	5,200	1,903	1,097
SWB kombi	174PS TDI PD	3,000	1,575 / 1,550	2,500 / 750	5,200	2,000	1,000

Roof load limit and trailer nose weight are both 100kg.

* For 12% gradient.

** Unladen weight includes full tank of fuel, excludes crew.

*** Payload with full tank of fuel, excluding crew.

Payload = gross vehicle weight - unladen weight.

The height measurements listed here may vary by ± 50mm depending on equipment fitted.

VAT information.

The VAT paid on the Transporter Sportline kombi can usually be recovered if the vehicle is purchased by a VAT registered business, as it offers a payload of 1,000kg. It is the customer's responsibility to deal with the VAT correctly. Customers should always seek professional advice to establish their own personal tax position.

Volkswagen service for your peace of mind.



Volkswagen Roadside Assistance.

Every new Volkswagen purchased benefits from an unlimited mileage, comprehensive recovery and assistance package across the UK and Europe for a full three years, operating 24 hours a day, 365 days a year. Fully trained technicians are able to diagnose

and repair most problems at the roadside, using Volkswagen equipment and parts. For more information ask your nearest Van Centre for a Volkswagen Roadside Assistance handbook.

The Volkswagen warranty.

Three-year warranty*.

All of the Sportline range come with a three-year/100,000 miles warranty, which protects your vehicle against the failure of most mechanical and electrical components due to manufacturing defects. This comprises a two-year manufacturer's warranty with unlimited mileage plus a further one-year/100,000 miles (whichever is soonest) Van Centre warranty. Should the mileage exceed 100,000 miles within the first two years, the manufacturer's two-year warranty will still be valid. If an additional warranty for subsequent years or higher mileage is desired, it may be purchased from an authorised Volkswagen Van Centre or Van Service Centre; however, this additional warranty must be purchased before the mileage reaches 100,000.

Three-year Paint warranty*.

The paintwork of all the Sportline range is covered against manufacturing defects for a period of three years. Naturally, the vehicle must be cared for in compliance with the operating instructions which will be found in your owners handbook.

12-year Body Protection warranty*.

The internal body sections and panels of all the Sportline range are covered against rusting through from the inside for 12 years. Naturally, the vehicle must be cared for in compliance with the operating instructions.

Service intervals for Diesel Engines.**

The LongLife Service regime is so called because there are no set service intervals. The interval between services, depending on how you drive your vehicle and the conditions of use, can be anywhere up to a maximum of approximately 18,000 miles or 24 months (whichever comes first). The Service Interval Display in the instrument panel will indicate when a service is required.

If you would like a more traditional service regime the vehicle can be adapted by your authorised Volkswagen Van Centre or Van Service Centre to the Time/Distance regime. This can be done at the point of vehicle sale or when an inspection service is carried out. An oil change is required at every 10,000 miles on the Time/Distance regime.

Volkswagen Commercial Vehicle Finance.†

Volkswagen Commercial Vehicle Finance offers a dedicated service to meet the needs of both the business user and the private motorist. They can help you choose the right type of finance package to meet your specific requirements. Please consult your authorised Volkswagen Van Centre for details.

Volkswagen Van Insurance.‡

Competitive insurance premiums are available to Volkswagen owners through Volkswagen Van Insurance. Volkswagen Van Insurance includes Genuine Volkswagen Parts and a three-year repairer guarantee, when using our approved network. The cover also includes a courtesy vehicle following an accident or recovered theft of your vehicle and up to £1,000 of 'tools in transit' cover is included at no additional cost. For a quotation, or to arrange complimentary seven-day insurance, call 0800 051 3138.

Volkswagen Original Parts®.

When you fit replacement parts to your vehicle, you need to know that they'll stand the test of time. Volkswagen Original Parts® are constructed to the highest standards, are cheaper than you might think and are widely available from Volkswagen Group's massive national distribution centre.

Options and accessories.

We know that no two businesses are the same. To this end, we have developed an extensive range of factory fitted, as well as Van Centre fitted accessories, so that your van can be enhanced with your own requirements in mind.

Volkswagen Assured Used Commercial Vehicles.

An increasing number of Volkswagen Van Centres are able to offer total peace of mind when purchasing a used van. You can rest in the confidence that every Volkswagen Assured Used Commercial Vehicle has been subjected to a comprehensive range of specialist checks that make them as safe a choice as a new Volkswagen van.

Volkswagen Van Rental.

Many Volkswagen Van Centres offer a cost-effective van rental service. It comes with the assurance that every van is late model, low mileage and presented in a high quality condition that reflects your business operation. Long-term business rental is also available. For more information on Volkswagen Van Rental, call 0845 602 4351.

* Full details of Volkswagen warranties are available from your authorised Volkswagen Van Centre or Van Service Centre.

** All mileages are approximate as the system uses kilometres as the distance measure. Please consult your authorised Volkswagen Van Centre or Van Service Centre for full details.

† Volkswagen Commercial Vehicle Finance is a trading name of Volkswagen Financial Services (UK) Limited. Subject to status. Finance available to over 18s only. Indemnities may be required.

‡ Exclusions apply. Volkswagen Van Insurance is underwritten and administered by Zurich Insurance Company. Volkswagen Van Insurance is a trading name of Volkswagen Insurance Service (Great Britain) Limited which is an appointed representative of Volkswagen Financial Services (UK) Limited, Freeport VWFS. Volkswagen Financial Services (UK) Limited and Zurich Insurance Company are authorised and regulated by the Financial Services Authority.

Please note: Some items of specification on Sportline vehicles are fitted in the UK by AB Crush (Panelcraft) Limited, an approved Volkswagen supplier. For details of UK fitted items please refer to 'standard specification' sections for each model. All data given and specifications are in accordance with information available at the time of going to print and are subject to change without notice. Vehicles not in current UK stock and customer order vehicles may take a number of weeks for delivery. Certain combinations of vehicle specifications and factory fitted extras are not compatible and therefore all orders received are subject to confirmation. Please check details and availability with an appropriate authorised Volkswagen Van Centre at the time of ordering. The Volkswagen Sportline range is available through Volkswagen Van Centres. The brand name Caddy® is used with the kind approval of 'Caddie S.A., France'.

The Sportline range

May 2009

This brochure supersedes all previous publications.
CVW203TS

www.volkswagen-vans.co.uk/sportline