



The new Audi A5 and S5 Cabriolet
Pricing and Specification Guide
Valid from July 2009



A User's Guide

This guide has been designed to help you tailor and price your chosen A5 Cabriolet quickly and logically. At the back of this guide, you will also find information on CO2 emissions-based taxation and the other services offered by Audi, including Finance and Insurance. If you wish, you can also go to audi.co.uk and configure your A5 Cabriolet online.

Tune into the Audi Channel at any time on Sky Guide No. 884 to see a whole range of programmes about the Audi range and our motorsport achievements.



Table of content

	Page Number
Introduction	
The A5 Cabriolet	
Engines and quattro®	6
Model details and prices	
Standard models	8
SE models	10
S line models	12
S5 quattro® models	14
Transmission	16
Colour and upholstery	
Paint finishes	18
Upholstery options	20
Colour and trim guide	24
Inlays	26
Options	
Wheels, tyres and suspension	28
Audio and communication	30
Steering wheels	32
Safety and security	33
Interior equipment	34
Exterior equipment	35
Seats	36
Audi exclusive	
Audi exclusive options	38
Audi exclusive line	44
Technical details	
Technical data	46
Dimensions	48
Additional information	50





The A5 Cabriolet

When Audi's Italian head of design, Walter da Silva, designed the Audi A5, he described it as 'a rhythm of lines' and the most beautiful car he'd ever built. The A5 Cabriolet has exactly the same qualities, with the added benefit of open-top driving. Its lightweight roof opens in just 15 seconds and closes in 17, and the optional head-level heating and solar heat-reflecting upholstery ensure that it's enjoyable to have the roof down, whatever the weather conditions.

Aside from the obvious benefits of a cabriolet, there are other features that are equally appealing. It accelerates from 0 to 62mph in just 5.6 seconds, on the way to an electronically limited top speed of 155mph. And there's a choice of impressive engines, the 2.0 TDI, 3.0 TDI, 3.2 FSI and S5 quattro®, which demonstrate our trademark fuel-efficient technology. Technical ingenuity and elegant design combine to make us rather proud of the A5 Cabriolet.

Engines

Petrol

All A5 Cabriolet petrol engines feature FSI® direct-injection – a unique Audi technology originally developed for the Le Mans 24-hour endurance race to deliver increased power and torque as well as enhanced fuel efficiency. The way it does this is, in theory, very simple. Precisely the right amount of fuel and air are injected directly into the combustion chambers, enabling the engine to 'breathe' more easily. At the same time, electronics monitor the engine load and adjust the injection process. The result – reduced heat-loss and increased output, with around a 15% reduction in fuel consumption and significantly lower exhaust emissions. Ideal for the buyer who wants an athletic, exhilarating drive without the drawbacks of excessive fuel costs or high emissions.

Diesel

All diesel engines from Audi are known as TDI. This impressive technology was originally pioneered by Audi in 1989, marking a departure from the noisy, fuel-thirsty diesel engines of the past. Like its FSI petrol counterpart, the TDI diesel engine is designed for power, performance, low fuel consumption and emissions.

All A5 Cabriolet TDI engines are based on the common rail system. Here, fuel is stored and kept at constant pressures of up to 1,600 bar, ready to feed a series of highly accurate piezo injectors, which control the rate and point of injection.

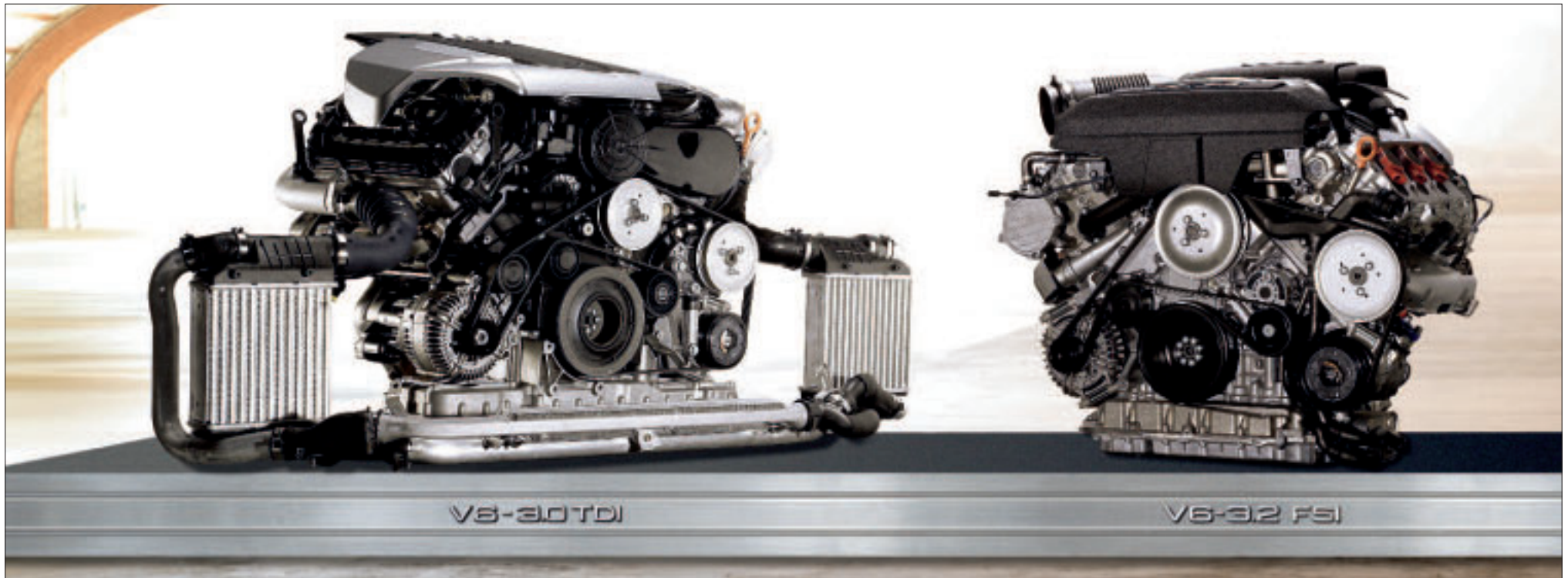

quattro®

It's the technology that has given Audi the edge on the racetrack ever since it was first introduced over 25 years ago – a technology that delivers ultimate control whilst enhancing the athletic characteristics which make the A5 Cabriolet so thrilling to drive. It's called quattro® permanent all-wheel-drive. The principle is simple: in the same way that four brakes ensure better deceleration, four permanently-driven wheels deliver better acceleration and road-holding, pushing or pulling the car as needed, for a driving experience that's both dynamic and safe. In the A5 Cabriolet, asymmetric-dynamic torque distribution continuously distributes drive power between the front and rear axles depending on weather conditions, road surface and gradient, which increases flexibility for an enhanced, more dynamic drive.

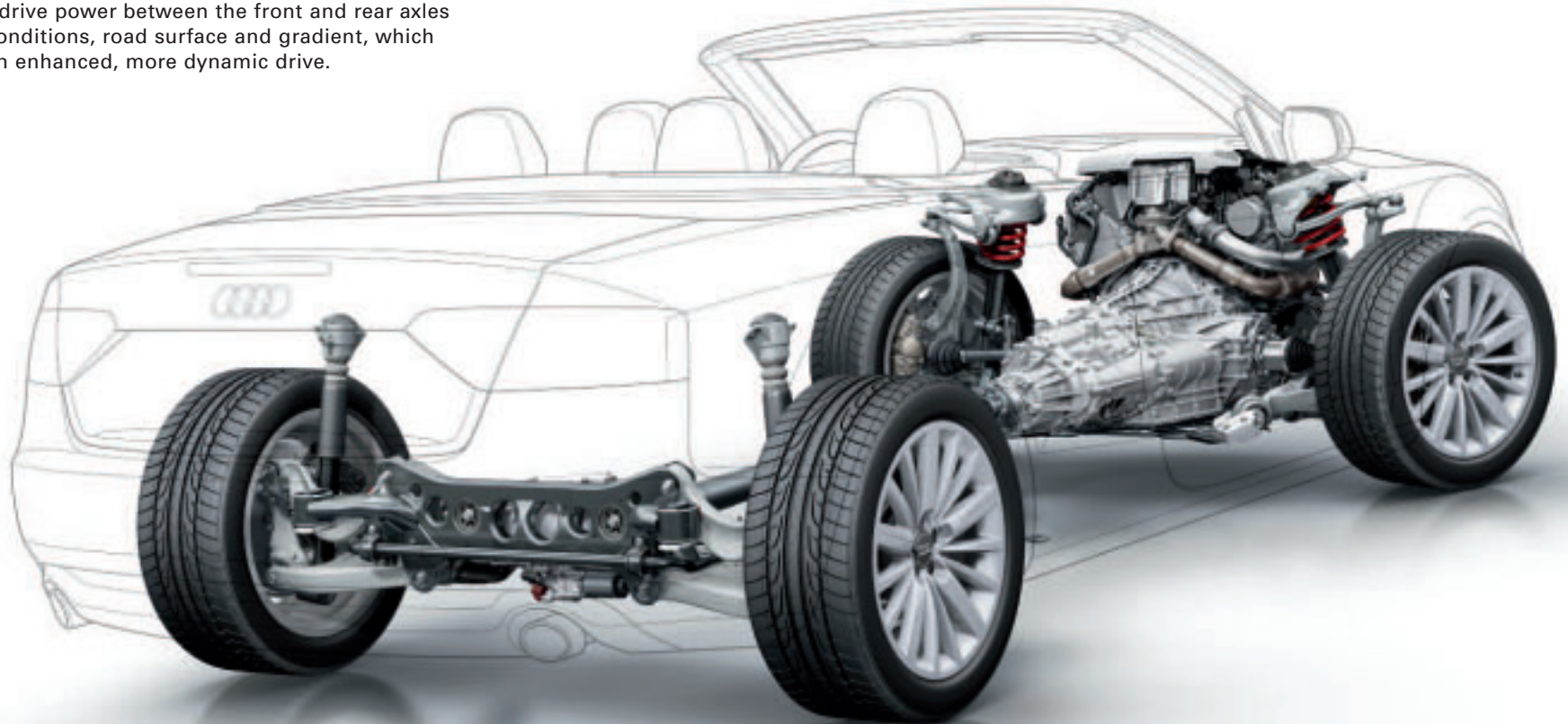

Standard model equipment

All A5 Cabriolet models have the following items of Standard equipment:

Engines

Automatic start/stop function for greater fuel and CO₂ efficiency. Comprising:

- Recuperation for optimal energy utilisation
- Energy-saving tips feature in Driver's Information System; including gearshift indicator

(Only available on the 2.0 TFSI manual engine)

Wheels, tyres and suspension

17 x 7.5J '6-arm' design alloy wheels with 245/45 R17 Y tyres and locking wheel bolts

Space-saver spare wheel

Audio and communication

Audi Concert audio system. Single CD with MP3 compatibility, colour centre console screen, SD memory card reader and AUX-IN socket in centre console

6 loudspeakers (80 Watts)

Safety and security

ESP (including limited-slip differential on FWD models)

First aid kit

Front and rear fog lights

Front and rear ISOFIX preparation with front passenger airbag de-activation switch

Front side airbags

Halogen daytime-running lights

Headlight range adjustment

Thatcham category 1 alarm and immobiliser

Toolkit and car jack

Warning triangle

Seats

Arcade cloth seats

Automatic seat belt feeder

Split folding rear seat – one touch operation

Interior equipment

1-zone climate control

3-spoke leather steering wheel

Driver's Information System (DIS)

Electric front windows

Electromechanical parking brake

Front and rear floor mats

Intelligent key

Interior chrome package

Micrometallic inlays

Steering column adjustment for rake and reach

Servotronic speed-related power-assisted steering (on 190PS models and above)

Exterior equipment

Fully automatic soft top (can be operated at speeds up to 31mph)

Exterior mirrors – electrically operated and heated

Front grille – Black gloss on 3.0 TDI and 3.2 FSI models, Stone grey on all others

Exhaust pipes – 4-cylinder models have two exhaust pipes on the left-hand side. 2.0 TFSI and 6-cylinder models have one exhaust pipe on either side

Exterior aluminium package



17 x 7.5J '6-arm' design alloy wheels



Fully automatic soft top

Standard model prices

Petrol

Engines	Power	Transmission	Basic RRP	Total RRP ^{inc. VAT}	Recommended OTR
2.0 TFSI	211PS	6-speed manual	£25,243.48	£29,030.00	£29,800.00
2.0 TFSI quattro®	211PS	7-speed S tronic	£27,752.17	£31,915.00	£32,710.00

Diesel

Engines	Power	Transmission	Basic RRP	Total RRP ^{inc. VAT}	Recommended OTR
2.0 TDI	170PS	6-speed manual	£25,030.43	£28,785.00	£29,530.00



Recommended On-The-Road (OTR) retail prices include: delivery charge, half a tank of fuel, number plates at £565.00 (inc. VAT) and Road Fund Licence (which may vary depending on model/transmission. See page 50 for details) and first registration fee at £55.00.

RRP – Recommended Retail Price.
Please note images shown are for illustration purposes only and do not necessarily depict UK specification.

SE model equipment

In addition to Standard model equipment:

Basic RRP	Total RRP <small>inc. VAT</small>
£1,608.70	£1,850.00

Wheels, tyres and suspension

17 x 7.5J '7-arm' design alloy wheels with 225/50 R17 tyres and locking wheel bolts

Audio and communication

Audi sound system speaker package, 10-speakers including subwoofer (180 Watts)

Seats

Milano leather seats

Safety and security

Automatic headlight operation
Automatic windscreen wipers
Rear acoustic parking system

Interior equipment

3-spoke leather multi-function steering wheel
Deluxe 3-zone climate control with separate air distribution and digital display for driver and front passenger. System includes air-conditioning controls in rear centre console for rear passenger compartment
Driver's Information System (DIS) in colour
Front centre armrest including 12V power socket
Wind deflector



17 x 7.5J '7-arm' design alloy wheels



Driver's Information System (DIS) in colour

SE model prices

Petrol

Engines	Power	Transmission	Basic RRP	Total RRP ^{inc. VAT}	Recommended OTR
2.0 TFSI	211PS	6-speed manual	£26,852.17	£30,880.00	£31,650.00
2.0 TFSI quattro®	211PS	7-speed S tronic	£29,360.87	£33,765.00	£34,560.00
3.2 FSI	265PS	multitronic	£30,895.65	£35,530.00	£36,365.00
3.2 FSI quattro®	265PS	7-speed S tronic	£32,169.57	£36,995.00	£37,830.00

Diesel

Engines	Power	Transmission	Basic RRP	Total RRP ^{inc. VAT}	Recommended OTR
2.0 TDI	170PS	6-speed manual	£26,639.13	£30,635.00	£31,380.00
2.7 TDI	190PS	multitronic	£29,573.91	£34,010.00	£34,805.00
3.0 TDI quattro®	240PS	7-speed S tronic	£32,300.00	£37,145.00	£37,940.00



Recommended On-The-Road (OTR) retail prices include: delivery charge, half a tank of fuel, number plates at £565.00 (inc. VAT) and Road Fund Licence (which may vary depending on model/transmission. See page 50 for details) and first registration fee at £55.00.

RRP – Recommended Retail Price. Please note images shown are for illustration purposes only and do not necessarily depict UK specification.

S line model equipment

In addition to SE model equipment:

Basic RRP	Total RRP <small>inc. VAT</small>
£2,130.43	£2,450.00

Wheels, tyres and suspension

18 x 8J '5-spoke' S line design alloy wheels with 245/40 R18 tyres and locking wheel bolts

Sports suspension with stiffer spring settings and dampers than Standard models

Interior equipment

3-spoke S line multi-function steering wheel (paddle shift for automatic models)

Black headlining

Matt-brushed aluminium inlays

Perforated leather gear knob

S line embossed Sport seats in Milano leather

S line sill plates

Exterior equipment

Acoustic hood with LED rear passenger reading lights

Bumper 'blade' in Platinum optic

Chrome fog light surround

Chrome rolled exhaust

S line exterior styling package including:

– S line side skirts

– S line front bumper

– S line rear diffuser on wings

Xenon headlights with LED daytime-running lights

LED rear lights



18 x 8J '5-spoke' design alloy wheels



Xenon headlights with LED daytime-running lights

S line model prices

Petrol

Engines	Power	Transmission	Basic RRP	Total RRP ^{inc. VAT}	Recommended OTR
2.0 TFSI	211PS	6-speed manual	£28,982.61	£33,330.00	£34,100.00
2.0 TFSI quattro®	211PS	7-speed S tronic	£31,491.30	£36,215.00	£37,010.00
3.2 FSI	265PS	multitronic	£33,026.09	£37,980.00	£38,815.00
3.2 FSI quattro®	265PS	7-speed S tronic	£34,300.00	£39,445.00	£40,280.00

Diesel

Engines	Power	Transmission	Basic RRP	Total RRP ^{inc. VAT}	Recommended OTR
2.0 TDI	170PS	6-speed manual	£28,769.57	£33,085.00	£33,830.00
2.7 TDI	190PS	multitronic	£31,704.35	£36,460.00	£37,255.00
3.0 TDI quattro®	240PS	7-speed S tronic	£34,430.43	£39,595.00	£40,390.00



Recommended On-The-Road (OTR) retail prices include: delivery charge, half a tank of fuel, number plates at £565.00 (inc. VAT) and Road Fund Licence (which may vary depending on model/transmission. See page 50 for details) and first registration fee at £55.00.

RRP – Recommended Retail Price.
Please note images shown are for illustration purposes only and do not necessarily depict UK specification.



S5 quattro® Cabriolet model equipment – in addition to SE model equipment:

One look at its muscular body styling, 19" alloy wheels and subtle V6T badging, and it'll come as no surprise that the Audi S5 Cabriolet features the new S tronic gearbox as standard, as well as a new powerful 3.0 litre V6 supercharged engine, capable of taking you from 0 to 62 mph in 5.6 seconds. And from the comfort and stability of a stylish, S5-embossed Silk Nappa leather Sports seat, you can sit back and enjoy every single unit of this engine's 333PS capability, safe in the knowledge that the quattro® permanent all-wheel-drive system will keep you exactly where you want to be – on the road.

But sleek styling and powerful performance in the S5 Cabriolet don't come at the expense of functional, driver-oriented specifications. Simple yet thoughtful touches, such as the matt-brushed aluminium inlays, S instrument dials and through-load facility have been included to ensure that your life runs as smoothly as your Audi does.

Wheels, tyres and suspension

19 x 8.5J '5-parallel-spoke' design alloy wheels with 255/35 R19 tyres

'S' Sports suspension

Safety and security

'S' model enhanced braking system

Interior equipment

3-spoke 'S' Sports multi-function leather steering wheel with silver stitching

Aluminium scuff plates with S5 logo

Interior lighting package

Inlays in matt-brushed aluminium

'S' instrument dials

Seats

S5 Sports seats with electric adjustment and lumbar support

Silk Nappa leather upholstery

Through-load facility

Exterior equipment

Acoustic hood with LED rear passenger reading lights

Aluminium-effect door mirror housings

Exhaust pipes – twin on left- and right-hand side in chrome rolled finish
Platinum grey matt grille, with vertical bars and chrome inserts

Painted brake callipers with S5 logo

'S' body styling

Xenon headlights with LED daytime-running lights and LED rear lights



Petrol

Engines	Power	Transmission	Basic RRP	Total RRP <small>inc. VAT</small>	Recommended OTR
S5 quattro®	333PS	7-speed S tronic	£36,008.70	£41,410.00	£42,245.00

Recommended On-The-Road (OTR) retail prices include: delivery charge, half a tank of fuel, number plates at £565.00 (inc. VAT), Road Fund Licence (which may vary depending on model/transmission – see page 50 for details) and first registration fee at £55.00.

RRP – Recommended Retail Price. Images are for general illustration purposes only and do not necessarily depict UK specification.



Transmission

multitronic®

Translating a driver's preferences and intentions into road performance, the multitronic® automatic transmission system entertains no compromises – whether in terms of dynamism, convenience or economy. multitronic® is available on front-wheel-drive models. A continuously variable transmission, multitronic® operates in an exceptionally wide range of gear ratios thanks to its steel link-plate chain construction. The result is exceptional driving comfort, as well as smooth, powerful acceleration over the entire range of engine speeds.

In addition, thanks to its lightweight design and the DRP Dynamic Regulating Programme which monitors gradient, road conditions and the way the driver is using the accelerator pedal, multitronic® also plays an instrumental role in reducing fuel consumption. And with seven simulated gear ratios available, you can enjoy all these benefits whilst adopting the dynamic driving style of a manual.

S tronic®

The revolutionary 7-speed S tronic gearbox combines sporty driving with the convenience and smooth, uninterrupted power of an automatic transmission. The technical basis of S tronic is the double clutch. This consists of two lubricated plates with hydraulically-regulated contact pressure. It means that S tronic works almost as two separate systems: one engaging the odd-numbered gears, the other the even-numbered gears, enabling gearshifts to be made in a fraction of a second, with no disruption to the power flow. So with S tronic, depending on how the mood takes you, you can either allow gear-changes to take place automatically or, for a sportier driving style, operate the system using the gear lever or the optional steering wheel shift-paddles. The choice is yours.



Transmission

	2.0 TFSI	2.0 TFSI quattro®	3.2 FSI	3.2 FSI quattro®	2.0 TDI	2.7 TDI	3.0 TDI quattro®	S5 quattro®	Basic RRP	Total RRP ^{inc. VAT}
Automatic 7-speed multitronic® transmission	•	-	S	-	-	S	-	-	£1,234.78	£1,420.00
Automatic 7-speed S tronic® transmission	-	S	-	S	-	-	S	S	£1,234.78	£1,420.00



- = Not available • = Available S = Standard

Paint finishes

Standard colours

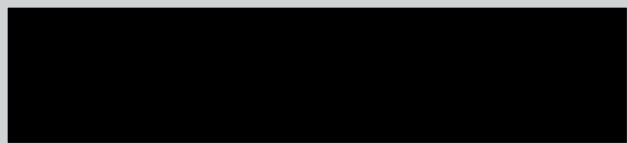

Brilliant black

A2



Brilliant red

C8



Ibis white

T9

Optional colours

Basic RRP	Total RRP <small>inc. VAT</small>
£508.70	£585.00

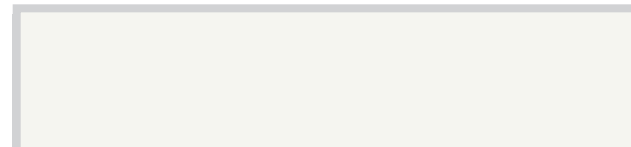

Ice silver, metallic

P5



Quartz grey, metallic

Q4



Meteor grey, pearl effect

X5



Garnet red, metallic

9C

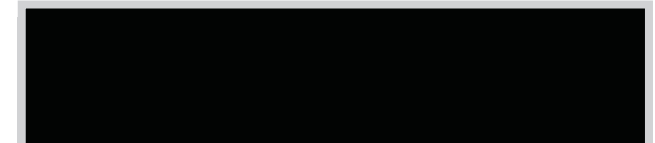

Phantom black, pearl effect

L8

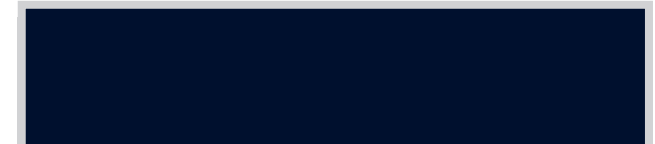

Deep sea blue, pearl effect

8A



Sahara silver, metallic (not available on S5 quattro*)

9T



Sphere blue, metallic (not available on S5 quattro*)

9F



Amethyst grey, pearl effect (not available on S5 quattro*)

1J

S line additional colours



Sprint blue, pearl effect (not available on S5 quattro*)

5N

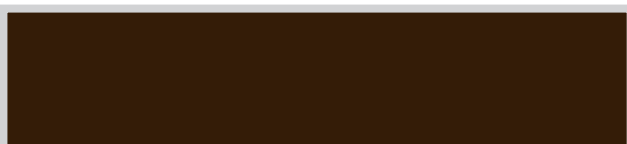

Teak brown, pearl effect (not available on S5 quattro*)

4U



Aruba blue, pearl effect (not available on S5 quattro*)

Q9



Aurum beige, metallic (not available on S5 quattro*)

C6



Monza silver, metallic (not available on S5 quattro*)

U7



Misano red, pearl effect (not available on S5 quattro*)

N9

Hood colours



Black

PA



Blue

PB



Brown

PW



Red

SF

Upholstery

Standard seats

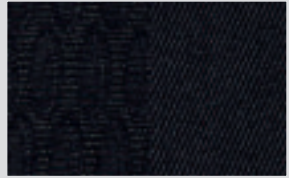

Arcade cloth, Black

GD/JN



Arcade cloth, Light grey

GE/AD



Milano leather, Black

GD/JN



Milano leather, Light grey

GE/AD



Milano leather, Cinnamon

GN/GJ



Milano leather, Cardamom beige

AN









Standard	SE	S line	S5 quattro*	Basic RRP	Total RRP ^{inc. VAT}
S	-	-	-	No charge	No charge
•	S	-	-	£1,095.65	£1,260.00

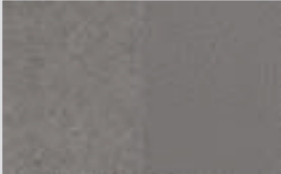
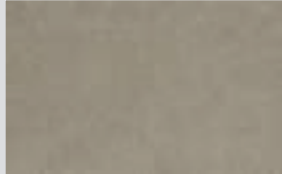

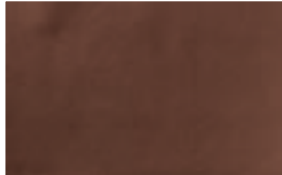
Sports seats in Cardamom beige (AN), Milano leather (N5W), head level heating system (9K1) and Laurel nutmeg inlays (7TD)

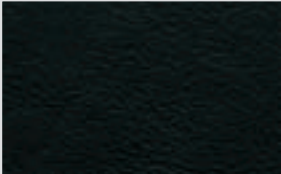
Upholstery

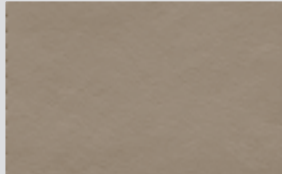

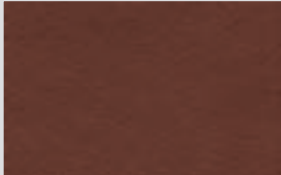
Sports seats – front, with 4-way electrical lumbar adjustment and manual height adjustment

				Standard	SE	S line	S5 quattro*	Basic RRP	Total RRP ^{inc. VAT}
				-	•	-	-	£404.35	£465.00
Leather/Alcantara, Black GD/JN	Leather/Alcantara, Light grey GE/AD	Leather/Alcantara, Cardamom beige AN							
				-	•	-	-	£404.35	£465.00
Milano leather, Black GD/JN	Milano leather, Light grey GE/AD	Milano leather, Cinnamon GN/GJ	Milano leather, Cardamom beige AN						
				-	•	-	-	£700.00	£805.00
Fine Nappa leather, Black GD/JN	Fine Nappa leather, Light grey GE/AD	Fine Nappa leather, Cardamom beige AN	Fine Nappa leather, Red AA/BF						
									
Fine Nappa leather, Luxor beige AC/GM	Fine Nappa leather, Cinnamon GN/GJ								

All leather upholstery choices include seats, head restraints, door inserts and front centre armrest in leather. Alcantara/leather choices include head restraints, seat side bolsters and front centre armrest in leather with the seat centres and door inserts in Alcantara.

Upholstery

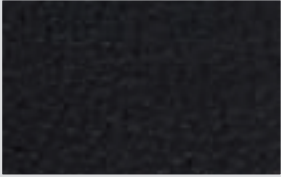
S line Sports seats – front, with 4-way electrical lumbar adjustment and manual height adjustment. Front seats with 'S line' logo available with black stitching on all upholsteries and silver stitching on leather/cloth and leather/Alcantara upholsteries.

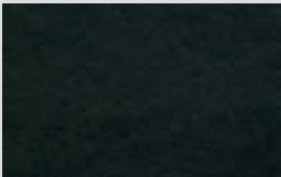
		Standard	SE	S line	S5 quattro®	Basic RRP	Total RRP ^{inc. VAT}
	QE	-	-	S	-	No charge	No charge
	QE	-	-	•	-	No charge	No charge
	QF	-	-	•	-	No charge	No charge
	QE	-	-	•	-	£300.00	£345.00



S line embossed Sports seats in Alcantara leather (N7K) and matt-brushed aluminium (5TG) inlays

Upholstery

Climate comfort seats – Climate-controlled front seats can be heated or cooled according to the driver’s and passenger’s requirements. Includes electrically-adjustable front seats and memory function for driver’s seat. Also included: door mirrors – electrically folding and auto-dimming with memory function, and auto-dimming rear view mirror. (Only available in Milano leather).



Milano leather, Black

GD/JN



Milano leather, Light grey

GE/AD



Milano leather, Cinnamon

GN/GJ



Milano leather, Cardamom beige

AN

Standard	S5	S line	S5 quattro®	Basic RRP	Total RRP ^{inc. VAT}
-	●	-	-	£2,256.52	£2,595.00

S5 Cabriolet quattro® Super Sports seats – S5 embossed seats with electric height adjustment, forwards and backwards position, backrest angle and lumbar support for driver and front-passenger seats

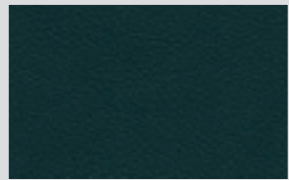

Silk Nappa leather, Black/Black

ZM/SC

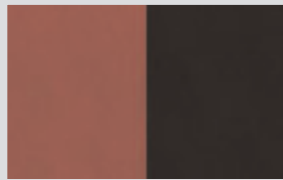

Silk Nappa leather, Magma red/Black

FA/SJ

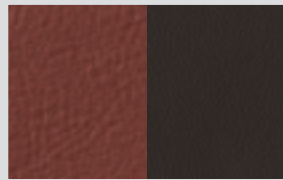

Silk Nappa leather, Mustang brown/Black

SH/SK

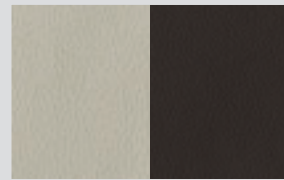

Silk Nappa leather, Spectral silver/Black

SP/SQ

-	-	-	S	No charge	No charge
---	---	---	---	-----------	-----------

Colour and trim guide

To help you choose the right interior for your Audi A5 Cabriolet, please use the guide below showing the carpet, dashboard and headlining colours that have been matched to your chosen upholstery.

Standard seats – Interior trim colours:

Order code	Upholstery	Carpet	Dashboard (upper/lower)	Headlining	Arcade cloth (N0B)	Milano leather (N5W)
GD/JN	Black	Black	Black/Black	Silver/Black	●	●
GE/AD	Light grey	Quartz grey	Black/Graphite grey	Silver/Black	●	●
GN/GJ	Cinnamon	Black	Black/Black	Silver/Black	–	●
AN	Cardamom beige	Coriander beige	Taupe beige/Tan beige	Linen beige	–	●

Sports seats – Interior trim colours:

Order code	Upholstery	Carpet	Dashboard (upper/lower)	Headlining	Leather/Alcantara (N7U)	Milano leather (N5W)	Fine Nappa leather (N3Q)
GD/JN	Black	Black	Black/Black	Silver/Black	●	●	●
GE/AD	Light grey	Quartz grey	Black/Graphite grey	Silver/Black	●	●	●
AN	Cardamom beige	Coriander beige	Taupe grey/Tan beige	Linen beige	●	●	●
AA/BF	Red	Black	Black/Black	Silver/Black	–	–	●
AC/GM	Luxor beige	Black	Black/Black	Silver/Black	–	–	●
GN/GJ	Cinnamon	Black	Black/Black	Silver/Black	–	●	●

S line Sports seats – Interior trim colours:

Order code	Upholstery	Carpet	Dashboard (upper/lower)	Headlining	Leather/Alcantara (N7K)	Milano leather (N1Y)	Fine Nappa leather (N2R)
QE (Black stitching)	Black	Black	Black/Black	Black	●	●	●
QF (Silver stitching)	Black	Black	Black/Black	Black	●	–	–

Climate comfort seats – Interior trim colours:

Order code	Upholstery	Carpet	Dashboard (upper/lower)	Headlining	Milano leather (N5W)
GD/JN	Black	Black	Black/Black	Silver/Black	●
GE/AD	Light grey	Quartz grey	Black/Graphite grey	Silver/Black	●
GN/GJ	Cinnamon	Black	Black/Black	Silver/Black	●
AN	Cardamom beige	Coriander beige	Taupe beige/Tan beige	Linen beige	●

Colour and trim guide

S5 Super Sports seats – Interior trim colours:

Order code	Upholstery	Carpet	Dashboard (upper/lower)	Headlining	Silk Nappa leather (N1U)
SH/SK	Mustang brown/Black	Black	Black/Black	Black/Silver	•
SP/SQ	Spectral silver/Black	Black	Black/Black	Black/Silver	•
FA/SJ	Magma red/Black	Black	Black/Black	Black/Silver	•
ZM/SC	Black/Black	Black	Black/Black	Black/Silver	•





To help you choose the right exterior for your Audi A5 Cabriolet, please use the guide below which shows possible paintwork and hood colour combinations.

Order code	Paint	Black (PA)	Brown (PW)	Blue (PB)	Red (SF)
T9	Ibis white	•	•	•	•
C8	Brilliant red	•	•	•	•
A2	Brilliant black	•	•	•	•
P5	Ice silver	•	•	•	•
Q4	Quartz grey	•	•	•	•
X5	Meteor grey	•	•	•	•
L8	Phantom black	•	•	•	•
8A	Deep sea blue	•	•	•	•
9T	Sahara silver	•	•	•	•
1J	Amethyst grey	•	•	•	•
4U	Teak brown	•	•	•	•
Q9	Aruba blue	•	•	•	•
9C	Garnet red	•	•	•	•
9F	Sphere blue	•	•	•	•

Inlays

Order code			Standard	SE	S line	S5 quattro®	Basic RRP	Total RRP ^{inc. VAT}
5MA		Micrometallic platinum	S	S	-	-	No charge	No charge
5TG		Matt-brushed aluminium	-	-	S	S	No charge	No charge
5TE		Aluminium hologram	•	•	-	-	£126.09	£145.00
5TK		Fine grain ash, Almond beige	•	•	-	-	£278.26	£320.00
5TZ		Fine grain birch wood, grey	-	-	-	•	£147.83	£170.00

Inlays

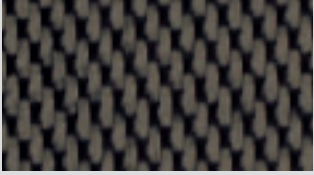
Order code			Standard	SE	S line	S5 quattro®	Basic RRP	Total RRP ^{inc. VAT}
5MG		Walnut brown	•	•	-	-	£278.26	£320.00
7TD		Laurel nutmeg	•	•	-	-	£278.26	£320.00
5TL		Piano finish, black	-	-	•	-	No charge	No charge
5MZ		Stainless steel mesh (centre console comes in Piano black)	-	-	-	•	£300.00	£345.00
5MK		Carbon atlas	-	-	-	•	£213.04	£245.00

Wheels, tyres and suspension

Order code		Standard	SE	S line	S5 quattro®	Basic RRP	Total RRP ^{inc. VAT}
CH5	17 x 7.5J '7-arm' design alloy wheels with 225/50 R17 tyres	•	S	-	-	£165.22	£190.00
PQ5	18 x 8.5J '10-spoke' design alloy wheels with 245/40 R18 tyres	-	-	•	-	No charge	No charge
PRR	18 x 8.5J '15-spoke star' design alloy wheels with 245/40 R18 Y tyres	-	•	-	-	£513.04	£590.00
PRV	19 x 8.5J '5-spoke Y' design alloy wheels with 255/35 R19 Y tyres	-	•	-	-	£1,104.35	£1,270.00
PQS	19 x 9J '20-spoke' design, 2-piece alloy wheels with 255/35 R19 Y tyres	-	-	•	-	£382.61	£440.00
PQ6	19 x 9J '5-segment-spoke' design wheels with 255/35 R19 tyres	-	•	-	-	£1,191.30	£1,370.00
		-	-	•	-	£382.61	£440.00



18 x 8J '10-spoke' design alloy wheels



18 x 8.5J '15-spoke star' design alloy wheels



19 x 8.5J '5-spoke Y' design alloy wheels

Wheels, tyres and suspension

Order code		Standard	SE	S line	S5 quattro®	Basic RRP	Total RRP ^{inc. VAT}
PQF	20 x 9J '7-arm double-spoke' design alloy wheels with 255/30 R20 tyres (only available in combination with quattro®)	-	-	•	-	£934.78	£1,075.00
		-	-	-	•	£826.09	£950.00
2H1 1N7	Audi drive select – with dynamic steering	-	•	•	•	£852.17	£980.00
2H1 1BL	Audi drive select – with damper control (only in combination with servotronic power steering)	-	•	-	-	£852.17	£980.00
		-	-	•	•	£513.04	£590.00
2H1 1BL 1N7	Audi drive select – full package	-	•	-	-	£1,460.87	£1,680.00
		-	-	•	•	£1,121.74	£1,290.00
GH2	Audi quattro® Sports differential – full package (must be combined with Audi drive select with dynamic steering or the full package. Only available on 3.0 TDI quattro®, 3.2 FSI quattro® and S5 quattro® models)	-	•	•	•	£400.00	£460.00
1N3	Servotronic power steering (standard on 190PS and above models)	•	•	•	S	£152.17	£175.00
1BE	Sports suspension , with stiffer springs, stiffer shock absorbers and a 20mm lower ride height	•	•	S	-	£213.04	£245.00



19 x 9J '20-spoke' design, 2-piece alloy wheels



19 x 8.5J '5-segment-spoke' design with tyres



20 x 9J '7-arm double-spoke' design alloy wheels

Audio and communication

Order code		Standard	SE	S line	S5 quattro®	Basic RRP	Total RRP ^{inc. VAT}
8UM	Audi Symphony radio , with front-loading MP3-compatible 6-CD changer, 6.5" colour screen and SD memory card reader and AUX-IN socket in centre console	•	•	•	•	£234.78	£270.00
UF7	Audi Music Interface , universal connection for use with stereo audio sources and iPod generation 4 onwards (iPod, iPod mini, iPod nano, iPod photo, iPod video). Provides intuitive control through the audio system and multi-function steering wheel. It also replicates the iPod display on the audio screen, including track titles. The interface provides power as well as a convenient rubberised storage tray. An adaptor cable is required at additional cost. Please consult your Audi Centre for details (includes 2 cables to connect your iPod or USB MP3 device)	•	•	•	•	£213.04	£245.00
9VK	Bang & Olufsen sound system , designed specifically for the A5 Cabriolet providing surround-sound reproduction with dynamic noise compensation, 14 high-performance loud speakers (505 Watt) and 10-channel amplifier	•	•	•	•	£447.83	£515.00
7D1	CD changer (only in combination with Technology Package)	•	•	•	•	£256.52	£295.00
7A6	CD changer (only in combination with DVD Satellite Navigation)	•	•	•	•	£256.52	£295.00
QV3	DAB digital radio	•	•	•	•	£256.52	£295.00
9ZX	Mobile telephone preparation – Bluetooth Interface . Provides handsfree connection via Bluetooth using mobile phone aerial. Please contact your Audi Centre for phone compatibility (only available in combination with multi-function steering wheel)	•	•	•	•	£217.39	£250.00
PT5	Mobile telephone preparation – Low . In front centre armrest, uses Bluetooth interface or cradle to connect to your A5 Cabriolet, including roof aerial for optimal reception and charger. A phone adaptor is required at extra cost, please consult your Audi Centre for phone compatibility. (Must be combined with either Concert radio or Symphony radio and multi-function steering wheel)	•	–	–	–	£447.83	£515.00
		–	•	•	•	£317.39	£365.00



Bang & Olufsen sound system



Mobile telephone preparation – High with privacy handset

Audio and communication

Order code		Standard	SE	S line	S5 quattro®	Basic RRP	Total RRP ^{inc. VAT}
9ZW	Mobile telephone preparation – High. Uses Bluetooth interface with no physical connection to your A5 Cabriolet, including roof aerial for optimal reception. Please note that your mobile phone must have SIM-Access Profile facility for full functionality. (Only in combination with Technology Package)	-	•	•	•	£552.17	£635.00
PT4	Mobile telephone preparation – High (with privacy handset). The handset allows passengers to make private calls, providing remote control of the telephone functions as well as a convenient SMS text messaging function. The handset is charged from a docking station integrated in the front centre armrest. (Only in combination with Technology Package)	-	•	•	•	£808.70	£930.00
QV9	TV reception – analogue and digital (only in combination with Technology Package)	-	•	•	•	£721.74	£830.00
PNG 8T1 UF7	Technology Package – HDD Satellite Navigation with MMI 3G – High, Audi Music Interface and cruise control	-	•	•	•	£1,517.39	£1,745.00
PNG 8T4 UF7	Technology Package – HDD Satellite Navigation with MMI 3G – High, Audi Music Interface and adaptive cruise control	-	•	•	•	£2,291.30	£2,635.00
PNW	DVD Satellite Navigation (only in combination with multi-function steering wheel – CD changer is recommended with this option)	•	•	•	•	£1,347.83	£1,550.00

HDD Satellite Navigation with MMI 3G

3rd generation MMI system including single CD/DVD player, 2 FM tuners, high-resolution (800 x 400) 7" colour TFT display, 2 SD card readers and 40GB hard drive, 10GB of which can be used to store up to 4,000 songs. HDD Navigation functionality includes 3D and topographical mapping display and advanced 3D building display.



MMI 3G – High, part of HDD Satellite Navigation



MMI 3G Control – High, part of HDD Satellite Navigation

Steering wheels

Order code		Standard	SE	S line	S5 quattro®	Basic RRP	Total RRP <small>inc. VAT</small>
2ZQ	Steering wheel – leather 4-spoke multi-function (only in combination with Audi lane assist)	-	•	•	-	No charge	No charge
2ZS	Steering wheel – leather 4-spoke multi-function with paddle shift for auto-transmission only (only in combination with Audi lane assist)	-	•	•	-	No charge	No charge
1XW	Steering wheel – leather 3-spoke multi-function	•	S	-	-	£213.04	£245.00
1XX	Steering wheel – leather 3-spoke multi-function with paddle shift for auto-transmission only	•	S	-	-	£326.09	£375.00



Safety and security

Order code		Standard	SE	S line	S5 quattro*	Basic RRP	Total RRP inc. VAT
UH2	Audi hill-hold assist , automatically activates electromechanical parking brake when stationary (not available in combination with start/stop technology)	•	•	•	•	£39.13	£45.00
7X1	Acoustic parking system (rear only)	•	S	S	S	£300.00	£345.00
7X4	Audi Parking System Plus , aids parking by acoustically and graphically indicating distances to obstacles in front of and behind your A5 Cabriolet	-	•	•	•	£256.52	£295.00
7X8	Audi Parking System Advanced , aids parking by acoustically and visually indicating distances to obstacles in front of and behind your A5 Cabriolet with guiding lines. Measured by ultrasonic sensors and camera integrated discreetly in the boot handle. Only in combination with Technology Package	-	•	•	•	£552.17	£635.00
7Y1	Audi side assist , aids the driver when changing lane. Audi side assist monitors the area behind your A5 Cabriolet using radar sensors located discreetly in the rear bumper, informing the driver via a visual warning signal in the door mirror if there is a vehicle in the driver's blind spot or approaching quickly from behind. The system is activated via a button in the driver's door	-	•	•	-	£382.61	£440.00
PU1	Audi lane assist , uses a discreet camera at the top of the windscreen to monitor the road ahead. The driver is warned via a vibration of the steering wheel if the vehicle is about to exit the lane unintentionally (only in combination with the 4-spoke leather multi-function steering wheel)	-	•	•	-	£382.61	£440.00
6XE	Door mirrors – electrically-folding	•	•	•	•	£147.83	£170.00
6XK 4L6 8N6	Door mirrors – electrically-folding and auto-dimming . Includes auto-dimming rear-view mirror and light and rain sensors which control the automatic headlights facility, the coming home/leaving home function and the automatic windscreen wipers	-	•	•	•	£404.35	£465.00
VC1	Garage door opener (HomeLink®*) . Programmable radio-operated remote control for compatible doors/gates. Control buttons integrated in the roof module at the front	•	•	•	•	£147.83	£170.00
7K6	Tyre pressure monitor	•	•	•	•	£65.22	£75.00

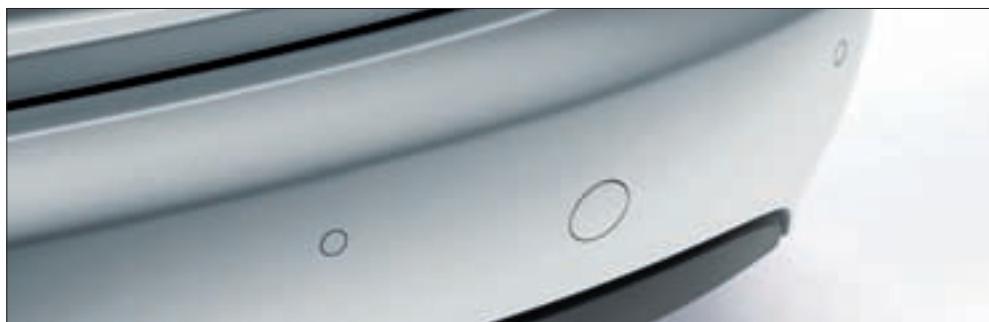

Audi Parking System Plus



Door mirror – electrically folding

Options are subject to availability and may extend delivery.
 - = Not available • = Available S = Standard

RRP – Recommended Retail Price.
 *HomeLink® is a registered trademark of Johnson Controls. For information on compatibility, visit www.homelink.com.

Interior equipment

Order code		Standard	SE	S line	S5 quattro®	Basic RRP	Total RRP <small>inc. VAT</small>
4K7	Advanced key. Access and authorisation system which automatically exchanges data between key and vehicle, allowing the driver to keep the key in their pocket or bag at all times. To unlock and open, simply lift the exterior door handle. To lock, press the button on the handle. Pressing the start/stop button integrated in the centre console starts and stops the engine	-	•	•	•	£421.74	£485.00
4L6 8N6	Auto-dimming rear-view mirror. Includes light and rain sensors which control the automatic headlights facility, the coming home/leaving home function and the automatic windscreen wipers	-	•	•	•	£169.57	£195.00
8T1	Cruise control	•	•	•	•	£160.87	£185.00
8T4	Adaptive cruise control. (Only available on 6-cylinder models)	-	•	•	•	£934.78	£1,075.00
QQ1	Interior light package – includes reading lights at rear, illuminated vents, internal door controls, vanity mirrors, active door reflectors, entrance lighting, footwell lighting at front and illuminated glove compartment	•	•	•	S	£86.96	£100.00
9K1	Head-level heating system – can be adjusted in three stages. Includes vents in the front seat backrest that blow hot air on your neck as you drive (can only be ordered in conjunction with heated climate comfort seats or heated Sports seats)	-	•	•	-	£295.65	£340.00
7HB	Leather package – includes leather-covered armrest on door panel for front and rear	-	•	•	•	£169.57	£195.00



Milano leather seats (N5W) in Cardamom beige (AN) with a 3-spoke multi-function steering wheel (1XW) and Symphony radio (8UM)

Exterior equipment

Order code		Standard	SE	S line	S5 quattro®	Basic RRP	Total RRP ^{inc. VAT}
3FT	Acoustic hood – fully automatic	•	•	S	S	£182.61	£210.00
PX1 8K4 8Q5	Adaptive Xenon Plus headlights with LED daytime-running lights. (Includes headlight washers)	•	•	–	–	£939.13	£1,080.00
8Q5	Adaptive lights. Swivelling headlights for improved illumination of a winding road	–	–	•	•	£278.26	£320.00
2Z0	Deletion of model and engine capacity designation at rear	•	•	•	–	No charge	No charge
2Z7	Deletion of engine capacity designation at rear	•	•	•	–	No charge	No charge
8N7	High beam assistant (only in combination with Xenon Plus headlights and Auto-dimming rear-view mirror)	•	•	•	•	£95.65	£110.00
1D2	Tow bar , factory fitted and removable	•	•	•	•	£552.17	£635.00



Seats

Order code		Standard	SE	S line	S5 quattro®	Basic RRP	Total RRP <small>inc. VAT</small>
PV3 6XL 4L6 8N6	Comfort pack , comprising electric front seats with memory function on driver's side, door mirrors – electrically folding and auto-dimming with memory function, auto-dimming rear-view mirror and light and rain sensors which control the automatic headlights facility	-	•	-	-	£1,191.30	£1,370.00
		-	-	•	-	£930.43	£1,070.00
		-	-	-	•	£508.70	£585.00
PV1	Electric front seats , with adjustment for height, forwards and backwards position, backrest angle and lumbar support for driver and front-passenger seats	-	•	-	-	£639.13	£735.00
		-	-	•	S	£378.26	£435.00
4A4	Heated front and outer rear seats	•	•	•	•	£382.61	£440.00
4A3	Heated front seats	•	•	•	•	£213.04	£245.00
3X2	Through-load facility , with removable ski bag for transporting long objects	•	•	•	S	£134.78	£155.00



Electric front seats



Through-load facility



Milano leather seats (N5W) in Cardamom beige (AN) and Laurel nutmeg inlays (7TD)



Every Audi is intrinsically exclusive. It's the breathtaking design, the exceptional engineering, the Vorsprung durch Technik. But for that added element of exclusivity – that distinguishing look that sets you apart from the rest – you can specify your A5 Cabriolet with options from Audi exclusive. Whether you want a completely unique, custom-mixed paint colour, seats in a combination of complementary shades or even individualised carpets and floor mats, Audi exclusive will enable you to drive the car you've always imagined.

For more information on any of the options over the following pages or to view swatches, simply ask a member of staff at your local Audi Centre.



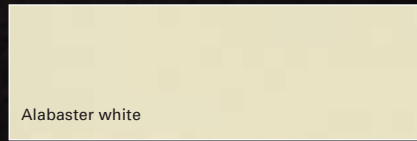

Alabaster white

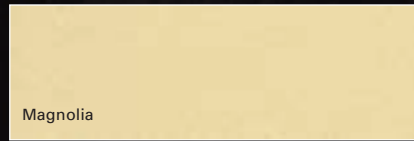

Magnolia

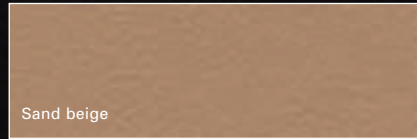

Sand beige

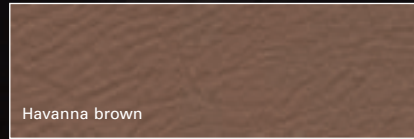

Havanna brown

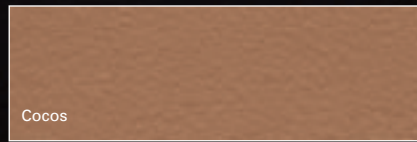

Cocos



Cognac



Saddle brown

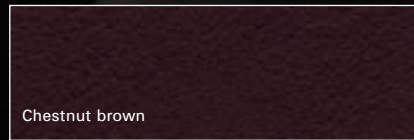

Chestnut brown

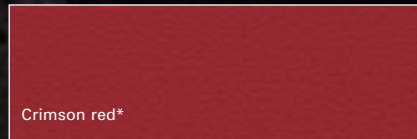

Crimson red*

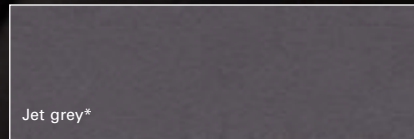

Jet grey*



Palace blue

Upholstery

With Audi exclusive, you can choose between Valcona leather and Alcantara, depending on the texture and flexibility you prefer in your car's upholstery. And once that's decided, you can specify your seats in an array of different colours shown to the left.

Choose just one all-over shade for each seat, or for a more striking look, customise each panel in two or more complementary colours from the distinctive Audi exclusive palette shown here. You can even choose the colour of the decorative stitching – to match or contrast with your chosen upholstery – from this varied collection. Whatever combination you decide upon, you're guaranteed to be extremely comfortable with the result.

Order code		Standard	SE	S line	S5 quattro*	Basic RRP	Total RRP ^{inc. VAT}
PYF/ S3G	Audi exclusive leather package (package 2) in Alcantara/leather, comprising the following in leather: Front and rear seat upholstery, head restraints, door trim inserts (in leather or Alcantara), front centre armrest (if ordered), backrest covers for front seats, seat side trims and add-on seat parts are colour-coordinated with the interior code.	-	•	-	-	£2,608.70	£3,000.00
	Note: backrest covers, add-on seat parts and seat side trims are colour-keyed. Not available in conjunction with comfort front seats.	-	-	•	-	£2,086.96	£2,400.00
		-	-	-	•	£1,565.22	£1,800.00
PYD/ S3G	Audi exclusive leather package (package 2) in Fine Nappa leather, comprising the following in leather: Front and rear seat upholstery, head restraints, door trim inserts (in leather or Alcantara), front centre armrest (if ordered), backrest covers for front seats, seat side trims and add-on seat parts are colour-coordinated with the interior code.	-	•	-	-	£2,608.70	£3,000.00
	Note: backrest covers, add-on seat parts and seat side trims are colour-keyed. Not available in conjunction with comfort front seats.	-	-	•	-	£2,086.96	£2,400.00
		-	-	-	•	£1,565.22	£1,800.00

*Not available in Alcantara.

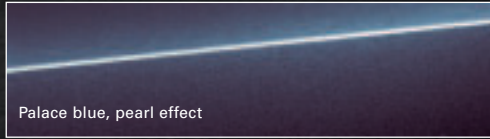

Palace blue, pearl effect



Morning Dew, metallic



Sand beige, pearl effect

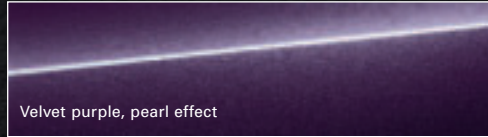

Velvet purple, pearl effect

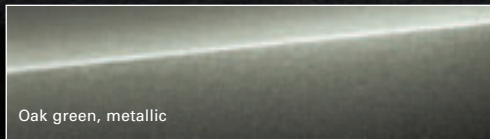

Oak green, metallic

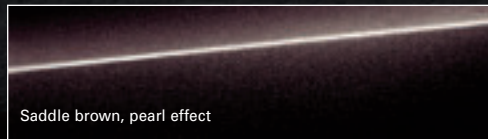

Saddle brown, pearl effect



Classic red, pearl effect

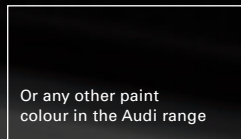

Or any other paint colour in the Audi range

Basic RRP	Total RRP ^{inc.} _{VAT}
£1,447.83	£1,665.00*

Paint

Everyone has a favourite colour. No matter what yours is, Audi exclusive provides a range of unique colours that have been designed to set your car apart. Choose from the swatches here, or specify any other paint colour in the Audi range – whether it's Jet blue from the Audi R8 or Alpine white from the original Audi quattro®. The choice is yours.

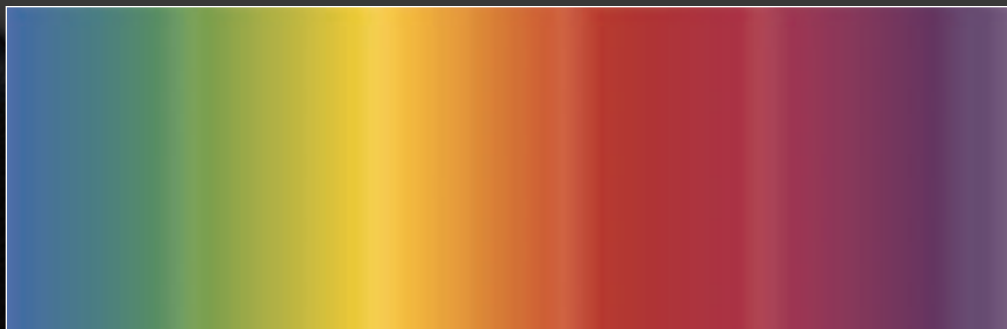

Customised paint

In a car made from Vorsprung durch Technik, there are no compromises. So if you have a particular colour in mind, we'll mix the exact water-based pearlescent or metallic-effect shade you want – whether it's the blue of your favourite shirt or the wall colour in your sitting room.

Basic RRP	Total RRP ^{inc.} _{VAT}
£2,043.47	£2,350.00*

*Not available on Standard models

Inlays

Inlays are the all-important ‘finishing touch’ that add flair and interest to the surfaces inside your car. So Audi exclusive have sourced a hugely varied range of materials from which to craft these elements – from Oak sepia to rich quilted maple wood. You can even customise your gear knob with one of the available woods, all of which are shown opposite.

Order code		Standard	SE	S line	S5 quattro®	Basic RRP	Total RRP ^{inc. VAT}
YTA/S3G	Audi exclusive - inlays from Audi exclusive range	-	•	•	•	£678.26	£780.00

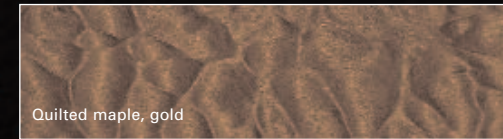
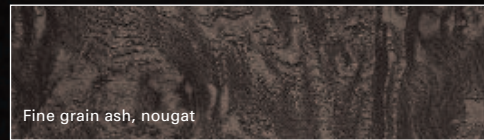
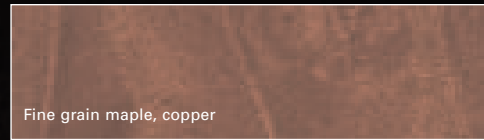

Steering wheels and controls pack

Our fingertips and palms contain more touch receptors than any other part of our body – so shouldn't the parts of our car we handle the most also be the most pleasing to touch? With this in mind, Audi exclusive enables you to customise the steering wheel of your choice in smooth, warm leather, in any of the colours shown on page 39. As with Audi exclusive seats, you even have free choice on the colour of the decorative stitching used. Choose a Controls Pack and you can extend this exclusive look and feel to your car's gearknob and gaiter too.



Order code		Standard	SE	S line	S5 quattro*	Basic RRP	Total RRP ^{inc. VAT}
YRB/S3G	Audi exclusive leather control elements, featuring steering wheel, gear lever knob, gear lever gaiter and handbrake grip from the Audi exclusive range	-	•	•	•	£600.00	£690.00
YRH/S3G	Audi exclusive leather steering wheel rim. Leather according to the Audi exclusive range	-	•	•	•	£300.00	£345.00

Carpets and floor mats

Exclusivity isn't just about choice and individuality – it's about attention to every detail in your A5 Cabriolet; and for us, that includes the carpets and floor mats. First, choose from ten different colours of high-quality velour carpets. Next, choose the colour of your car's floor mats from the same list, whilst using the palette of Audi upholstery colours detailed on page 39 to select a leather colour for the mats' decorative leather piping – matched or contrasting, depending on your personal taste. Floor mats are included when you order Audi exclusive carpet; but if you wish, they can also be purchased separately in a set of four.

Carpet colours

- ▶ Alabaster white
- ▶ Magnolia
- ▶ Sand beige
- ▶ Havanna brown
- ▶ Cocos
- ▶ Cognac
- ▶ Chestnut brown
- ▶ Palace blue
- ▶ Amethyst grey



Order code		Standard	SE	S line	S5 quattro®	Basic RRP	Total RRP <small>inc. VAT</small>
YSR/S3G	Audi exclusive floor mats with piping (4 floor mats). The leather piping of the additional floor mats is colour-coordinated with the mats themselves unless otherwise specified. A colour from the Audi exclusive presenter can also be specified for the leather piping of the additional floor mats. A colour from the Audi exclusive program or standard colour range can be specified for the carpet section of the additional floor mats. The additional floor mats need not necessarily be in the same colour as the carpet. Note: not available in conjunction with YSQ.	-	•	•	•	£365.22	£420.00
YSQ/S3G	Audi exclusive carpet incl. 4 floor mats. The leather piping on the additional floor mats is colour-coordinated with the mats themselves unless specified otherwise. A colour from the Audi exclusive presenter can also be specified for the leather piping. A colour from the Audi exclusive or standard colour range can be specified for the carpet section of the additional floor mats. The additional floor mats need not necessarily be in the same colour as the carpet. Note: not available in conjunction with YSR.	-	•	•	•	£721.74	£830.00

Audi exclusive line

Audi exclusive is ultimately about choice – but if you’d rather leave some of the decisions in the capable hands of our designers, the expert team at quattro® GmbH have compiled Audi exclusive line, combining some of the most popular elements of the exclusive range in one stylish, beautifully co-ordinated package. The package gives you:

- ▶ Front sports seats
- ▶ Electric lumbar supports for the front seats
- ▶ Seat side sections and head restraints with coloured piping, steering wheel rim and gear lever gaiter with coloured stitching (piping and stitching to match seat centre section)
- ▶ Two-colour seat upholstery with piping (seat side sections black/seat centre section in choice of alabaster white, crimson red or cognac) in Fine Nappa leather (including heat-up resistance leather for the front seats)
- ▶ Door trim inserts in leather to match seat centre section
- ▶ Sports steering wheel, 3-spoke design, with coloured stitching (to match seat centre section); optionally: 3-spoke multifunction sports steering wheel with or without gearshift function with coloured stitching (to match seat centre section).
- ▶ Matt brushed aluminium inlays or Walnut brown as an option
- ▶ Black interior (including black add-on parts)
- ▶ Floor mats with coloured piping (to match seat centre section)
- ▶ Audi exclusive door sill trims

Note: if ordering Audi lane assist, it can only be combined with the corresponding leather steering wheel in 4-spoke design without coloured stitching.



Order code		Standard	SE	S line	S5 quattro®	Basic RRP	Total RRP <small>inc. VAT</small>
WQK	Audi exclusive line	-	•	-	-	£1,739.93	£2,000.00



Crimson red



Alabaster white



Cognac brown



Technical data

A5 Cabriolet

Petrol									
Engine	Cylinder	Displacement, cubic cm (valves per cylinder)	Max. power ¹ , PS	Max. torque, Nm at rpm	Transmission	CO ₂ emissions ² , g/km	0-62mph acceleration, seconds	Top speed, mph	ABI insurance group
2.0 TFSI	4-cylinder	1984	211	350/1500-4200	6-speed manual	156	7.5	150	17E
2.0 TFSI	4-cylinder	1984	211	350/1500-4200	multitronic®	174	7.9	145	17E
2.0 TFSI quattro®	4-cylinder	1984	211	350/1500-4200	7-speed S tronic	177	7.3	147	TBC
3.2 FSI	V6	3197	265	330/3000-5000	multitronic®	199	6.9	153	17E
3.2 FSI quattro®	V6	3197	265	330/3000-5000	7-speed S tronic	219	6.9	155	TBC
S5 quattro®	V6	2995	333	440/2900-5300	7-speed S tronic	224	5.6	155	TBC

Diesel

2.0 TDI	4-cylinder	1968	170	350/1750-2500	6-speed manual	148	8.3	140	TBC
2.7 TDI	V6	2698	190	400/1400-3250	multitronic	169	7.4	140	TBC
3.0 TDI quattro®	V6	2967	240	500/1500-3000	7-speed S tronic	179	6.4	154	18E

¹ The given value was obtained in accordance with the specified measurement procedure (the respective current version of the Directive 80/1269/EEC).

² The given values were calculated in accordance with the specified measurement procedure (the respective current version of Directive 80/1268/EEC). This information does not relate to a single vehicle and does not comprise part of the offer but is merely intended for the purpose of comparison between the different vehicle types.

Weights, kg			Max. trailer load ⁴ , kg			Volumes			Fuel consumption, mpg (l/100km)		
Unladen weight ³	Gross weight limit	Nose weight	unbraked	with 12% gradient	with 8% gradient	Luggage compartment capacity, litres		Fuel tank capacity approx, litres	Urban	Extra Urban	Combined
						Rear seats upright	Rear seats folded				
1630	2130	80	750	1500	1700	320	750	65	33.2 (8.5)	49.6 (5.7)	42.2 (6.7)
1655	2155	80	750	1500	1700	320	750	65	28.5 (9.9)	47.1 (6.6)	38.2 (7.4)
1735	2235	80	750	1700	1900	320	750	65	29.7 (9.5)	42.8 (6.6)	36.7 (7.7)
1710	2210	80	750	1700	1800	320	750	65	23.3 (12.1)	43.5 (6.5)	32.8 (8.6)
1785	2285	80	750	1900	2100	320	750	65	20.5 (13.8)	40.4 (7.0)	29.7 (9.5)
1875	2375	80	750	1900	2100	320	750	64	20.5 (13.8)	38.7 (7.3)	29.1 (9.7)

1660	2160	80	750	1600	1800	320	750	65	40.4 (7.0)	57.7 (4.9)	49.6 (5.7)
1785	2285	80	750	1700	1900	320	750	65	36.7 (7.7)	48.7 (5.8)	43.5 (6.5)
1860	2360	80	750	1900	2100	320	750	65	33.2 (8.5)	48.7 (5.8)	41.5 (6.8)

³ Vehicle's unladen weight without driver (calculated in accordance with the current version of Directive 80/1268/EEC). The fitting of additional equipment may increase the vehicle's unladen weight and drag coefficient, whereupon the potential carrying capacity and top speed will be correspondingly reduced.

⁴ The engine's power output always goes down with increasing altitude. At 1000m above sea level, and for every additional 1000m, deduct 10% from the weight of the outfit (trailer load limit + gross weight of the towing vehicle).

* Loaded up to roof with rear seat folded down.

Dimensions

A5 Cabriolet

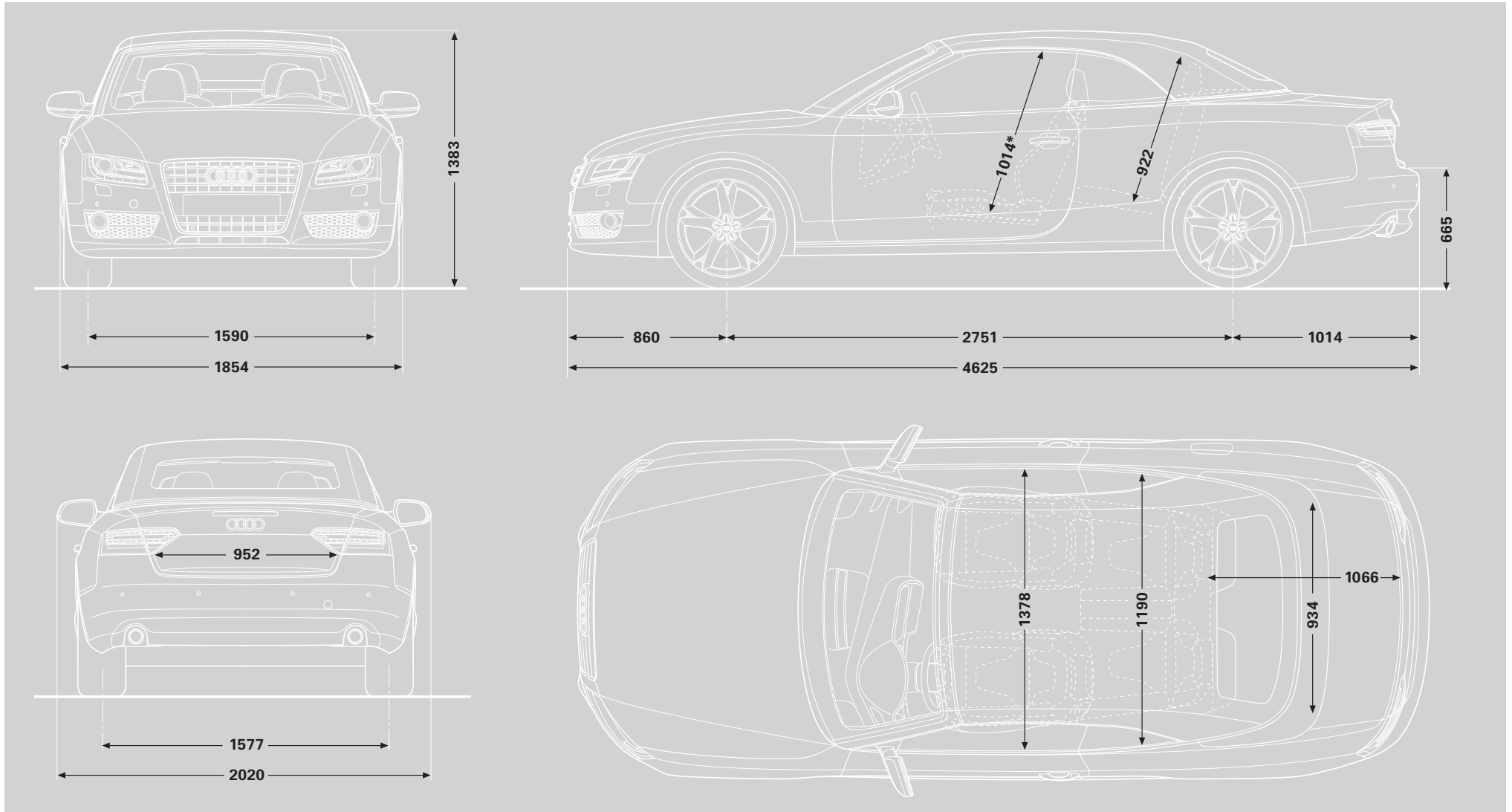

Dimensions

S5 Cabriolet

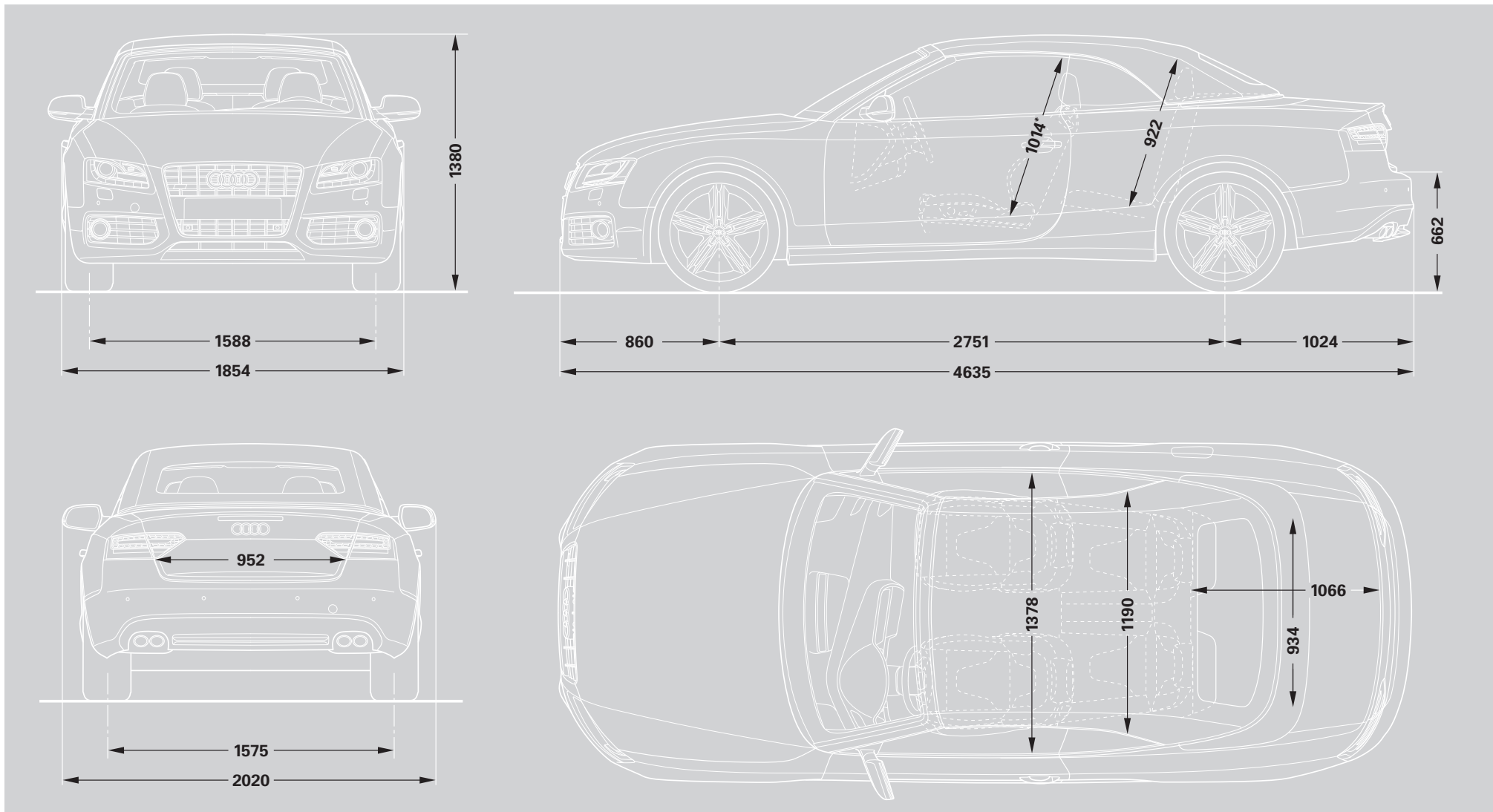

Dimensions were measured with vehicle at unladen weight, ground clearance measured with vehicle carrying its maximum load. Luggage compartment volume in litres: 320 with hood open, 360 with hood closed, 750 with rear seats folded (measured by the VDA standard test method using 200 x 100 x 50 mm blocks; second value: with rear seat folded down). Turning circle approx 11.4m.

Dimensions in millimetres.
*Maximum headroom.

Additional information

CO₂ data and information

CO₂ emissions-based Vehicle Excise Duty

Vehicle Excise Duty (Road Fund Licence) is based upon the amount of Carbon Dioxide (CO₂) a vehicle emits, measured in grams per kilometre (g/km). The DVLA has created thirteen categories:

Petrol and Diesel engines	
A – up to 100g/km	£0.00
B – 101 to 110g/km	£35.00
C – 111 to 120g/km	£35.00
D – 121 to 130g/km	£120.00
E – 131 to 140g/km	£120.00
F – 141 to 150g/km	£125.00
G – 151 to 165g/km	£150.00
H – 166 to 175g/km	£175.00
I – 176 to 185g/km	£175.00
J – 186 to 200g/km	£215.00
K* – 201 to 225g/km	£215.00
L – 226 to 255g/km	£405.00
M – over 255g/km	£405.00

*Band K includes cars that have a CO₂ figure over 225g/kg but were registered before 23 March 2006.

Audi Service

Servicing tailored to your needs

Regular servicing is key to safeguarding your Audi's performance and a full Audi service history could help you preserve the future re-sale value. To make servicing easy, the Audi Service Schedules have been designed to work with your individual driving style and vehicle.

There are two schedules available and your Audi Centre will advise which schedule is most suited to your needs. The conventional fixed Audi Inspection Service schedule

Inspection Service Schedule

Vehicle usage:	
Mileage	Less than 10,000* miles per annum
Type of journey	Mainly city/town centre driving. Short journeys
Conditions	Frequent cold starts. High engine loading – e.g. frequent hill climbs, vehicle fully loaded, towing
Driving style	Uneconomical – e.g. heavy acceleration, heavy braking, constant changes in speed, constant use of high revs, 'sporty' driving

Fixed Audi Inspection Service Intervals:	
Oil-change Service	Fixed to every 10,000* miles/1 year
Inspection Service	Fixed to every 20,000* miles/3 years, then every 20,000* miles/2 years thereafter

*As indicated by the service interval display. Mileages are approximate as the Service Indicator system uses kilometres as its distance measurement.

has fixed intervals for the Oil Change and Inspection Service that are based on time and distance, whichever comes first. With the Audi LongLife Service schedule, sensors take account of driving style and conditions in which the vehicle is used to indicate when the Oil Change Service is required. Oil Change Service intervals are therefore variable and are conveniently indicated via the on-board service interval display.

LongLife Service Regime

Vehicle usage:	
Mileage	More than 30 miles per day
Type of journey	Motorway and main road driving. Mainly longer distance journeys. Constant speeds
Conditions	Normal engine loading – e.g. with little or no towing, with little or no hill climbs. Normal vehicle loading
Driving style	Moderate acceleration, moderate braking, engine revs mainly below 3,000

Audi LongLife Service Intervals:	
Oil-change Service	Variable to a maximum of every 20,000* miles/2 years
Inspection Service	Fixed to every 20,000* miles/3 years, then every 20,000* miles/2 years thereafter

Service by Design

At Audi, we believe our customers have the right to expect excellent service each and every time they make contact with us. To ensure that this happens, we have agreed a set of service standards with our Audi Centre network that governs the way they do business with you. These standards apply to both Sales and Aftersales, and we actively monitor our Centres to ensure that you receive the highest level of customer service. These service standards will ensure a consistent, stress-free experience whenever you are in contact with anyone representing the Audi brand.

Every Audi Centre will be open during the following hours:

Sales: 9am-6pm Monday to Friday
9am-5pm Saturday

Service: 8am-6pm Monday to Friday
8.30am-1pm Saturday

Sunday opening at local discretion.

Test drives

Whilst we cannot always have the desired demonstrator car ready immediately, we will confirm arrangements for a test drive within two working days (subject to status).

New Car delivery

Once we have confirmed a delivery date with you, we will keep you informed of progress. In the unlikely event of a delay, we will provide you with a courtesy car to minimise inconvenience and keep you mobile.

Delivery to any location within the UK

To maximise your Audi experience right from the first day of ownership, we will deliver your car to your preferred location – whether that's home or your place of work (subject to reasonable notice).

Every attention to detail

Your ownership experience starts with half a tank of fuel.

Quotation response

We are committed to answering any quotation request within 1 working day.

Training

We run a continuous training development programme for all our staff so that we consistently deliver a high-quality, professional service.

Formal complaints procedure

We have a complaints procedure designed to ensure any negative issue you raise with us is dealt with properly.

Courtesy cars

When your car is off the road, perhaps due to a scheduled service or MOT, we will offer you an Audi Courtesy Vehicle until yours is ready. We'll even collect from and deliver to your chosen location, keeping hassle to an absolute minimum.

All our courtesy cars are insured and fuelled

Upon collection or delivery, your courtesy car will have a minimum of a quarter of a tank of fuel; all we ask is that you replace any fuel used before returning it to us. On presentation of your driving licence, we will also insure the car free of charge.

Service bookings

If you do not require a courtesy car, we will service your Audi within a maximum of 5 working days. If you do choose to take a courtesy car, we will promise to service your vehicle within a maximum of 10 working days.

Cleaning

When your car comes to our workshop, we will wash and vacuum it at no extra cost.

No hidden charges

You will be consulted before we carry out any necessary work on your vehicle, and anything charged for will be itemised on your bill. No extra work will be undertaken without your permission.

A personal service

All work will be done by a named Audi Technician, to whom you can personally direct questions or requests should you need to.

Environmental commitment

We promise to dispose of all non-biodegradable materials from your vehicle in a responsible manner.



Pricing information

Pricing

Prices and specifications given are correct at the time of printing. Always check details with your Audi Centre, as Audi policies are continually developing. We reserve the right to change prices or specifications at any time.

All prices are subject to VAT, currently charged at 15%.

Delivery charges and number plates are not included in the vehicle price.

<u>Delivery charge</u>	<u>£471.30</u>
<u>Number plates</u>	<u>£20.00</u>
<u>VAT</u>	<u>£73.70</u>
<u>Total</u>	<u>£565.00</u>

Audi Roadside Assistance

Your new car comes complete with complimentary roadside assistance and recovery across the UK provided by RAC Motoring Services. Also included is roadside assistance throughout Europe, managed by RAC Motoring Services.

Audi Customer Care

Every new Audi benefits from the comprehensive Audi Customer Care Package, which comprises:

- ▶ A 3-year Audi warranty, which covers you for unlimited mileage in the first 2 years of ownership, with a full mechanical and electrical warranty which covers you for up to 60,000 miles in the third year
- ▶ A 3-year paint warranty
- ▶ A 12-year anti-corrosion warranty
- ▶ Up to 3 years' UK roadside assistance and recovery

This package, together with Audi variable Service intervals, offers a combination unmatched by any other major manufacturer. Contact your Audi Centre for full details.

Audi Tax-Free Sales

If you are entitled to purchase a vehicle free of VAT, normally through Military or Diplomatic privilege, please contact your local Audi Centre for full details.

Should you have any difficulty obtaining the information you require, please call Freephone 0800 585878.

Audi Finance

Audi Finance specialise in providing funding solutions for Audi drivers. Whether your Audi is for private or business use, there are a range of funding options to choose from.

Below is the full range of finance products.

- ▶ Solutions – a Personal Contract Plan
- ▶ Hire purchase
- ▶ Lease purchase
- ▶ Finance lease
- ▶ Contract hire

With all products, you can choose a fixed-cost maintenance plan designed to help you budget accurately.

No matter what Audi model you choose, your local Audi Centre can provide you with a personalised quote which could fit your budget and motoring needs.

Audi Finance is a trading name of Volkswagen Financial Services (UK) Limited. An offer of finance depends on certain conditions. Available to people over 18 in the UK only.

Audi Insurance

Competitive comprehensive motor insurance designed specially for Audi drivers. All new Audi models come with complimentary seven-day cover upon request – we'll email a cover note directly to your Audi Centre, enabling them to tax your car easily. This way, you can drive straight out of the showroom. Taking out an annual policy is easy and can begin as soon as your free seven-day cover expires.

For more information, contact your local Audi Centre. Alternatively, call 0800 051 3146 for a quote and to receive 7 days' complimentary cover for your new Audi.

Audi Insurance is underwritten and administered by Zurich Insurance Company.

Audi UK

Customer Services
Selectapost 29
Sheffield
S97 3FG
0800 699888
www.audi.co.uk

Specifications and prices subject
to change without notice.

© Audi UK

Printed in the UK
Edition 1.3. 07/09
2010 Model year



Mixed Sources
Product group from well-managed
forests and other controlled sources

Cert no. TT-COC-002327
www.fsc.org
© 1996 Forest Stewardship Council