



[View offers](#)



[Book a test drive](#) [AMG test drive](#)



[Find a Retailer](#)



[View the Range Guide](#)

G-Class



Effective from 1 April 2016.

Mercedes-Benz





> View offers



Book a > test drive > AMG test drive



> Find a Retailer



> View the Range Guide

Contents

Model prices	17	Sports Styling package	38	Colours and materials	48
Finance offers	18	Driving Assistance package	39	Technical data	51
Model lines	22	Entertainment package	40	Road Fund Licence	56
Mercedes-AMG driver training	30	Winter package	41	Services and insurance	57
Standard equipment	32	Pricing summary for packages	42	Mercedes-Benz Finance	58
Wheels	36	Optional equipment	43		



> View offers



Book a > test drive > AMG test drive



> Find a Retailer



> View the Range Guide

The hard facts to melt your heart

At Mercedes-Benz we appreciate the importance of detail. Over the following pages you'll find model prices and a breakdown of standard and optional equipment, as well as details of the comprehensive services and benefits that are available to every Mercedes-Benz driver.

See Mercedes-Benz in a new light. Now is the time to get yourself behind the wheel of a G-Class. Choose from a number of attractive finance offers. Please see pages 18–21 for further details, or visit www.mercedes-benz.co.uk/offers

Of course, some things have to be experienced to be truly appreciated, such as the qualities that set a Mercedes-Benz apart. Which is why we'd like to invite you for a test drive at your local Mercedes-Benz Retailer. Alternatively, you can make arrangements by visiting www.mercedes-benz.co.uk/testdrive

For more information visit www.mercedes-benz.co.uk or call 0333 222 0500.



> View offers



Book a > test drive > AMG test drive



> Find a Retailer



> View the Range Guide



Model features optional equipment at an additional cost.



[View offers](#)



[Book a test drive](#) [AMG test drive](#)



[Find a Retailer](#)



[View the Range Guide](#)



Model features optional equipment at an additional cost.



> View offers



Book a > test drive > AMG test drive



> Find a Retailer



> View the Range Guide



Model features optional equipment at an additional cost.



> View offers



Book a > test drive > AMG test drive



> Find a Retailer



> View the Range Guide



Model features optional equipment at an additional cost.



> View offers



Book a > test drive > AMG test drive



> Find a Retailer



> View the Range Guide



Model features optional equipment at an additional cost.



> View offers



Book a > test drive > AMG test drive



> Find a Retailer



> View the Range Guide



Model features optional equipment at an additional cost.



[View offers](#)



[Book a test drive](#) [AMG test drive](#)



[Find a Retailer](#)



[View the Range Guide](#)



Model features optional equipment at an additional cost.



> View offers



Book a > test drive > AMG test drive



> Find a Retailer



> View the Range Guide





> View offers



Book a > test drive > AMG test drive



> Find a Retailer



> View the Range Guide

We are G-Class.

A claim that visitors to the production facility in Graz will hear often. The G-Class has been hand-built here for the last 35 years – filling everyone involved with pride. The variety of models necessitates to this day a manual process on just one production line. From a range of more than 10,000 individual parts, experienced technicians therefore select the 3000 or so that they need, which they then assemble with exemplary care to create a new G-Class. Only after more than 100 man-hours of work – almost three times as much as for a machine-produced vehicle – will a G-Class leave its place of origin.



> View offers



Book a > test drive > AMG test drive



> Find a Retailer



> View the Range Guide



13

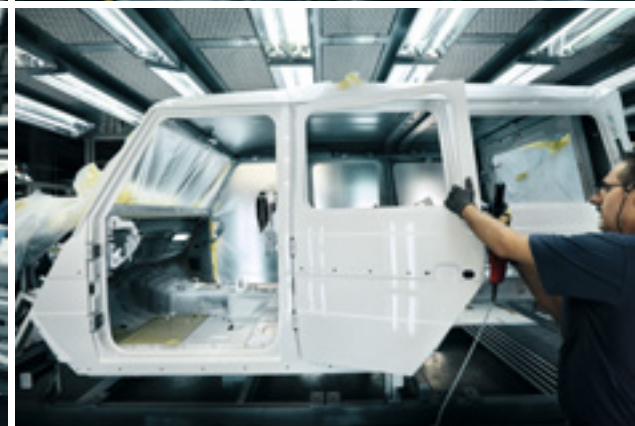



> View offers



Book a > test drive > AMG test drive



> Find a Retailer



> View the Range Guide

Boulders protruding half a metre out of the track. Massive tree roots breaking through the surface. The sort of terrain that would defeat any other vehicle. Welcome to the 'Schöckl' mountain. During the ongoing process of development, a G-Class must survive several thousand kilometres or more on the company's own test track. Only once the axles, frame, bodyshell, drive train and major assemblies are proven to hold out longer than their drivers, will we certify them as 'Schöckl-proof and ready for series production'.

Tried, tested and Schöckl-proof.





> View offers



Book a > test drive > AMG test drive



> Find a Retailer



> View the Range Guide



Model features optional equipment at an additional cost.



> View offers



Book a > test drive > AMG test drive



> Find a Retailer



> View the Range Guide



Model features optional equipment at an additional cost.



Model prices

Engine	Model line	Transmission	CO ₂	Basic RRP excl. VAT (£)	Total RRP incl. VAT (£)	Road Fund Licence (£) ¹	Rec. OTR price (£) ²	P11D value (£)	BiK tax rate 2016/17 (%)
G 350 d Diesel – 2,987 cc, 6-cylinder, 211 hp/155 kW	–	7G-TRONIC PLUS 7-speed automatic	261	71,687.50	86,025.00	1,120.00	87,815.00	86,640.00	37
Mercedes-AMG									
Mercedes-AMG G 63 Petrol – 5,461 cc, 8-cylinder, 571 hp/420 kW	–	AMG SPEEDSHIFT PLUS 7-speed auto.	322	108,254.17	129,905.00	1,120.00	131,695.00	130,520.00	34
Mercedes-AMG EDITION 463									
Mercedes-AMG G 63 Petrol – 5,461 cc, 8-cylinder, 571 hp/420 kW	–	AMG SPEEDSHIFT PLUS 7-speed auto.	322	123,500.00	148,200.00	1,120.00	149,990.00	148,815.00	37
Mercedes-AMG Colour Edition									
Mercedes-AMG G 63 Petrol – 5,461 cc, 8-cylinder, 571 hp/420 kW	Solar beam	AMG SPEEDSHIFT PLUS 7-speed auto.	322	121,554.17	145,865.00	1,120.00	147,655.00	146,480.00	37
Mercedes-AMG G 63 Petrol – 5,461 cc, 8-cylinder, 571 hp/420 kW	Tomato red Alien green Sunset beam	AMG SPEEDSHIFT PLUS 7-speed auto.	322	124,054.17	148,865.00	1,120.00	150,655.00	149,480.00	37
Mercedes-AMG G 63 Petrol – 5,461 cc, 8-cylinder, 571 hp/420 kW	Galactic beam	AMG SPEEDSHIFT PLUS 7-speed auto.	322	124,887.50	149,865.00	1,120.00	151,655.00	150,480.00	37

¹A different first year rate of Vehicle Excise Duty (Road Fund Licence) applies for new cars. Please refer to page 56 for the relevant rate for the second and subsequent years

²Recommended on-the-road price: these prices reflect the Road Fund Licence applicable to the standard model plus £670.00 additional costs necessary to put your car on the road.

Included are a standard UK delivery charge (£540.00 incl. VAT), new vehicle registration fee (£55.00), number plates (£25.00 incl. VAT) and fuel (£50.00 incl. VAT). VAT is calculated at the standard rate of 20%



Mercedes-Benz Finance

It comes with a specification list worth exploring

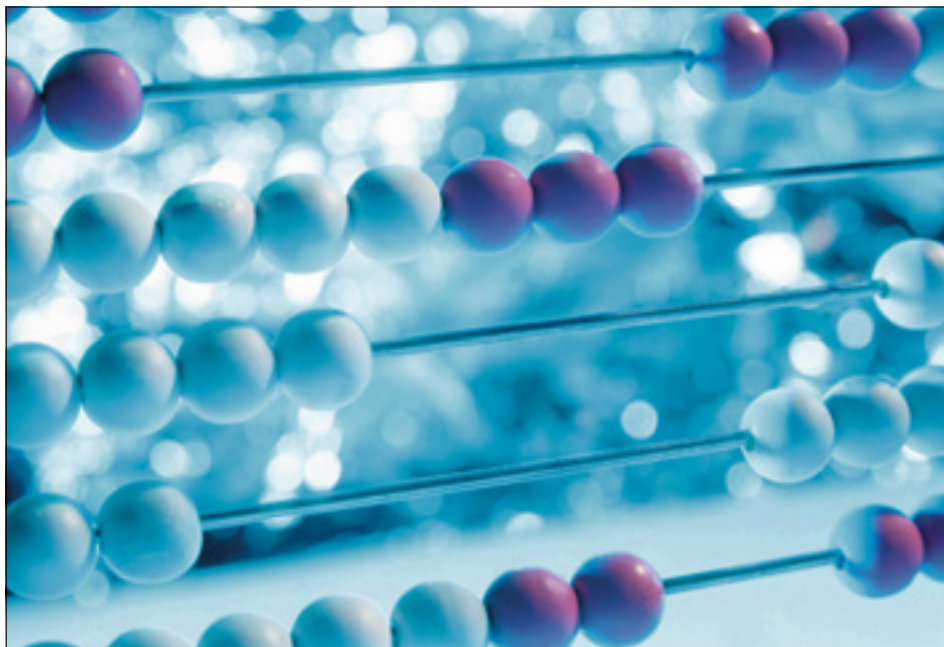

G 350 d with automatic transmission and metallic paint (representative example)

24 monthly payments of ¹	£1,399.00
Customer deposit	£13,419.38
On-the-road price	£87,815.00
Optional purchase payment ²	£48,250.00
Amount of credit	£74,395.62
Duration of agreement	24 months
Total amount payable ³	£95,255.38
Purchase activation fee ²	£10.00
APR	6.2%
Fixed interest rate	5.98%
Excess mileage	12p per mile



Example offer – 6.2% APR Representative

	Automatic	Metallic	On-the-road price	Customer deposit	24 monthly payments of ¹
G350d	●	●	£87,815.00	£13,419.38	£1,399.00

- Standard equipment

Mercedes-Benz Service Care

- Mercedes-Benz trained Technicians
- Maintained by Mercedes-Benz Retailers
- Meets requirements of Mercedes-Benz Agility finance agreement

Mercedes-Benz Motor Insurance

- 24/7 UK accident recovery
- We use Mercedes-Benz GenuineParts
- To qualify for up to 10% discount online, go to www.mercedes-benz.co.uk/motorinsurance
- Alternatively, call Mercedes-Benz Motor Insurance now on **0345 600 2180**⁴ for an annual quote

We may decline to quote in some circumstances. Mercedes-Benz Motor Insurance is underwritten by Aviva Insurance Limited

Content relating to finance is promoted by Mercedes-Benz Finance. Your Retailer may offer finance on behalf of other companies.

Orders/credit approvals on selected G-Class models only, between 1 April and 30 June 2016, registered by 30 September 2016; excluding Mercedes-AMG G 63 models. Some combinations of features/options may not be available. Please contact your local Mercedes-Benz Retailer for availability

¹Based on a Mercedes-Benz Agility agreement. Vehicle condition, excess mileage and other charges may be payable. Quotations available on request for alternative contract lengths and mileages.

Guarantees may be required. Credit provided, subject to status, by Mercedes-Benz Finance, MK15 8BA

²Payable if you exercise the option to purchase the car

³Includes optional purchase payment, purchase activation fee and Retailer deposit contribution (where applicable)

⁴Calls are charged at local rate and may be recorded



Mercedes-Benz Finance

Even the finance offer is beautifully put together



Mercedes-AMG G 63 with automatic transmission and metallic paint (representative example)

36 monthly payments of ¹	£1,899.00
Customer deposit	£23,412.75
On-the-road price	£131,695.00
Optional purchase payment ²	£54,825.00
Amount of credit	£108,282.25
Duration of agreement	36 months
Total amount payable ³	£146,611.75
Purchase activation fee ²	£10.00
APR	6.2%
Fixed interest rate	5.98%
Excess mileage	12p per mile



Example offer – 6.2% APR Representative

	Automatic	Metallic	On-the-road price	Customer deposit	36 monthly payments of ¹
Mercedes-AMG G 63	●	●	£131,695.00	£23,412.75	£1,899.00

- Standard equipment

Mercedes-Benz Service Care

- Mercedes-Benz trained Technicians
- Maintained by Mercedes-Benz Retailers
- Meets requirements of Mercedes-Benz Agility finance agreement

Mercedes-Benz Motor Insurance

- 24/7 UK accident recovery
- We use Mercedes-Benz GenuineParts
- To qualify for up to 10% discount go online, to www.mercedes-benz.co.uk/motorinsurance
- Alternatively, call Mercedes-Benz Motor Insurance now on **0345 600 2180⁴** for an annual quote

We may decline to quote in some circumstances. Mercedes-Benz Motor Insurance is underwritten by Aviva Insurance Limited

Content relating to finance is promoted by Mercedes-Benz Finance. Your Retailer may offer finance on behalf of other companies.

Orders/credit approvals on Mercedes-AMG G 63 4MATIC models only, between 1 April and 30 June 2016, registered by 30 September 2016; excluding non-Mercedes-AMG models. Some combinations of features/options may not be available. Please contact your local Mercedes-Benz Retailer for availability

¹Based on a Mercedes-Benz Agility agreement. Vehicle condition, excess mileage and other charges may be payable. Quotations available on request for alternative contract lengths and mileages.

Guarantees may be required. Credit provided, subject to status, by Mercedes-Benz Finance, MK15 8BA

²Payable if you exercise the option to purchase the car

³Includes optional purchase payment, purchase activation fee and Retailer deposit contribution (where applicable)

⁴Calls are charged at local rate and may be recorded



> View offers



Book a > test drive > AMG test drive



> Find a Retailer



> View the Range Guide

G 350 d





Now in its fourth decade, the G-Class boasts the same classic lines that have always made it such a unique presence. Its large glass area features distinctively shaped load compartment windows; the side skirts, shoulder lines, roof lines and side rubbing strips are almost exactly parallel, and the high wheel arches and wide track, together with a rear that's slightly thicker at the base, add up to a sturdy looking body with optimum off-road ability.

Inside, the spacious G-Class cabin is supremely comfortable whatever the distance or weather, thanks to a 2,850 mm wheelbase, heat-insulating glass all round, and heated seats front and rear. The G-Class accommodates equipment with ease too, offering up to 2,250 litres of luggage capacity and easy access via the large side-hinged tailgate. The standard 1/3:2/3 split folding rear seat and load-securing points further enhance its versatility.

Exterior





- 18" alloy wheels – 5-twin-spoke design, 265/60 tyres
- Bi-xenon headlamps and LED daytime running lamps
- Exterior mirrors – electrically adjustable, heated and painted in vehicle colour
- Metallic paint
- Parking Guidance with PARKTRONIC
- Privacy glass
- Rain-sensing wipers
- Reversing camera
- Tow bar

Interior

- Ambient lighting
- COMAND Online system with Media Interface

- DAB digital radio tuner
- Front and rear seats – heated
- Instrument cluster with colour display
- Leather upholstery in black, alpaca grey or chestnut
- Surround sound system – Harman Kardon® Logic 7® with 12 high-performance speakers
- Twin bottle holder in rear

Trim and Upholstery

- | | |
|--|---|
| Anthracite poplar wood | Leather – black |
|  |  |
| Leather – alpaca grey | Leather – chestnut |
|  |  |



> View offers



Book a > test drive > AMG test drive



> Find a Retailer



> View the Range Guide

Mercedes-AMG G 63





> View offers



Book a > test drive > AMG test drive



> Find a Retailer



> View the Range Guide

With 544 hp (400 kW) from its AMG biturbo V8, 760 Nm of torque and fuel-saving features such as ECO start/stop, the Mercedes-AMG G 63 is a remarkable combination of exhilaration and efficiency. Visually, it's simply unmistakable, thanks to the AMG two-bar grille with chrome trim, AMG wheel arch extensions, 'V8 BITURBO' badges on the front wings and an AMG exhaust system with side-exiting twin chromed tailpipes. Also fitted as standard are the Exterior Styling package and 20" AMG 5-twin-spoke alloy wheels

with titanium grey finish, red-painted brake calipers and 275/50 tyres. The cabin is similarly special, with illuminated AMG stainless steel door sill panels, designo leather upholstery, leather trim for the dashboard and AMG performance multi-function steering wheel, door panels in ruffled leather, ambient interior lighting, chrome trim and a designo black DINAMICA microfibre roof lining. There's also a choice of three designo wood trims and the option of AMG carbon-fibre trim for an even more dynamic look.

Exterior

20" alloy wheels – 5-twin-spoke design, titanium grey high-sheen finish, 275/50 tyres

AMG door sill panels in polished stainless steel

AMG logo in front grille

AMG radiator grille featuring twin chromed louvres with central Mercedes-Benz star

AMG red brake calipers

AMG sports exhaust system with chrome-trimmed twin tailpipes

Chrome package and Exterior Styling package

Electric steel sunroof – tilting/sliding, with one-touch opening

Metallic paint

Privacy glass

Interior

AMG instrument cluster with colour display (TFT technology)

COMAND Online system with Media Interface

DAB digital radio tuner

Single-tone designo leather in a choice of eight colours

Surround sound system – Harman Kardon® Logic 7® with 12 high-performance speakers

Steering wheel – multi-function AMG performance steering wheel trimmed in black nappa leather

THERMATIC – automatic climate control

Twin bottle holder in rear

Trim and Upholstery

designo black piano lacquer

designo leather – black



Please refer to page 49 for the full range of standard designo trim and leather choices



> View offers



Book a > test drive > AMG test drive



> Find a Retailer



> View the Range Guide

Mercedes-AMG EDITION 463



Protective grilles for headlamps not shown



Two-tone seats in high-quality designo leather



Protective grilles for headlamps



21" black alloy wheels (R12)



> View offers



Book a > test drive > AMG test drive



> Find a Retailer



> View the Range Guide

With the new EDITION 463 special model, Mercedes-AMG is giving the G-Class an impressive sporty look. The exquisite interior specification includes a two-tone instrument panel, two-tone seats in high-quality designo leather with side bolsters in carbon-look leather and contrasting topstitching, seat and door centre panels in a diamond design, carbon-fibre trim and door handles in nappa leather.

On the outside, a stainless steel guard under the engine, AMG sport stripes along the sides, a protective-strip insert in black aluminium-look as well as exclusive 21" forged wheels underscore both the dynamics and exclusivity of the special model. The EDITION 463 special model is based on the Mercedes-AMG G 63.

Exterior

21" alloy wheels – 5-twin-spoke design, matt black finish, 275/50 tyres

AMG sports stripes along sides

Metallic paint

Stainless steel guard under engine

Protective grilles for headlamps

Winter package, including auxiliary heater and heated windscreen

Interior

designo Exclusive package – without embossed crests in the head restraints

Driving Assistance package, including Blind Spot Assist and DISTRONIC PLUS

Entertainment package, including rear seat entertainment system and TV tuner

Two-tone seats in high-quality designo leather

Seat and door centre sections with diamond-pattern design in designo colour

Trim and Upholstery

AMG carbon fibre



designo leather – black



designo leather – light brown



designo leather – porcelain





> View offers



Book a > test drive > AMG test drive



> Find a Retailer



> View the Range Guide

Mercedes-AMG G 63 Colour Edition



Mercedes-AMG G 63 Colour Edition – solar beam with obsidian black exterior trim highlights. Image shows optional wheels (code R11)



Interior contrast stitching matching the exterior paint colour



AMG carbon fibre trim



> View offers



Book a > test drive > AMG test drive



> Find a Retailer



> View the Range Guide

What could be more striking than the Mercedes-AMG G 63? Perhaps a version of the same with an injection of strong, vivid colour? The new Mercedes-AMG G 63 Colour Edition offers five new exterior paints – tomato red, alien green, galactic beam, solar beam and sunset beam – all with complimentary sports styling details inside and out. Obsidian black accents feature on the trim, mirrors, roof, bumpers, fender flares and spare wheel

cover. The vibrant contrast continues in the interior with matching body colour contrast stitching on key elements including seats, dashboard, centre console and door panel. All models come as standard with AMG carbon fibre trim and black designo nappa leather upholstery regardless of which exterior colour is chosen. The result is a truly outstanding, highly energising look for a Mercedes-AMG G 63 like no other.



Mercedes-AMG G 63 Colour Edition – in a choice of five colours

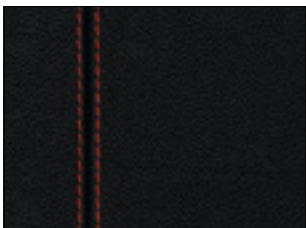

Tomato red (code 3150)

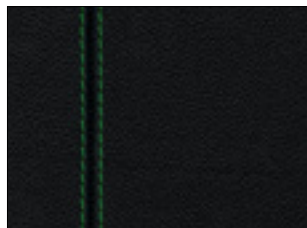

Alien green (code 6166)

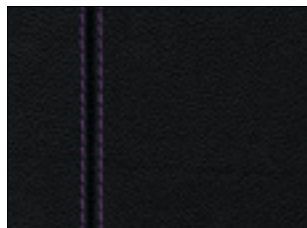

Galactic beam (code 4171)

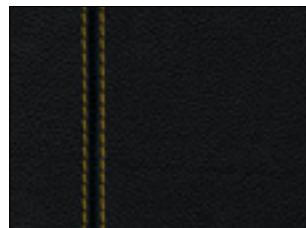

Solar beam (code 1278)

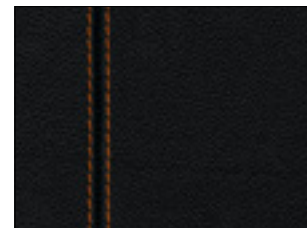

Sunset beam (code 2173)



Exclusive driver training for Mercedes-AMG owners

All Mercedes-AMG customers are invited to a complimentary AMG Driving Academy Training experience at Mercedes-Benz World.



With friendly one-to-one tuition from a professional Mercedes-AMG driver, your training will be personalised to you. You'll push Mercedes-AMG driving performance and your driving skills to the limits on our track and purpose-built low friction dynamic handling facilities.

Through high-speed and adrenaline-fuelled exercises you'll experience oversteer, understeer, slaloms and many more performance driving skills. Designed as part of your ownership experience, this will lay the foundations to master a high-performance vehicle, develop driving skills with maximum enjoyment and prepare you to take full command of your own Mercedes-AMG.

TERMS AND CONDITIONS

The following only are eligible: the first purchaser/registered keeper of a newly-registered Mercedes-AMG; the second owner/registered keeper of a Mercedes-AMG purchased from a Mercedes-Benz Retailer, where the vehicle is less than 90 days from registration. The AMG Driving Academy Training experience is the AMG BASIC-Training as detailed in the further information above and must be booked and taken within six months of delivery of your Mercedes-AMG; it cannot be exchanged and cannot be transferred for any other driving experience. The Training experience is available Monday to Friday only and is subject to availability. Mercedes-Benz UK Limited reserves the right to amend or withdraw this Training experience. Attendees must hold a full UK driving licence. Attendees will be required to sign the Mercedes-Benz World Driving Risk Acknowledgement prior to undertaking the Training experience. The Training experience is also subject to the Mercedes-Benz World Terms and Conditions, as applicable.



> View offers



Book a > test drive > AMG test drive



> Find a Retailer



> View the Range Guide





> View offers



Book a > test drive > AMG test drive



> Find a Retailer



> View the Range Guide

Standard equipment



Colour display in instrument panel



Sequentially lockable differentials



Parking Guidance with PARKTRONIC

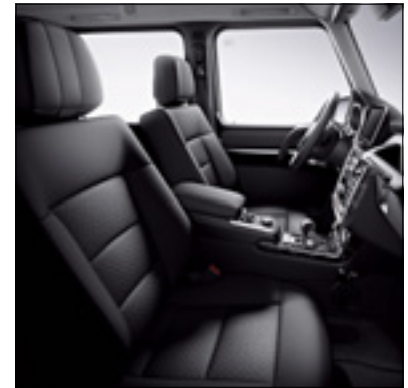

Front seats – electrically adjustable



THERMATIC – automatic climate control



Harman Kardon® Logic 7® surround sound system



Ambient interior lighting



Bi-xenon headlamps/LED daytime running lamps



Item	G 350 d	Mercedes-AMG G 63
Transmission and Suspension		
7G-TRONIC PLUS 7-speed transmission with cruise control and variable speed limiter	●	-
AMG SPEEDSHIFT PLUS 7G-TRONIC 7-speed automatic transmission with SPEEDTRONIC cruise control	-	●
ECO start/stop function	-	●
Permanent four-wheel drive with differentials	●	●
Exterior		
Chrome package	-	●
Chrome trim for gearshift lever frame		
Luggage compartment door sill panel in chrome with 'AMG' lettering ('Mercedes-Benz' lettering for G 350 d)		
Radiator grille with chrome highlights		
Switch for seat adjustment and speaker grille surround in front doors		
Exterior Styling package	-	●
Running boards left and right		
Spare wheel cover in stainless steel with three-dimensional Mercedes-Benz star		
AMG bodystyling with exclusive G 63 AMG front aprons with cooling air intakes in black and AMG flared wheel arches in vehicle colour	-	●
AMG brake calipers, painted red	-	●
AMG brake calipers, painted silver - only in conjunction with galactic beam (code 4171) and tomato red (code 3150)	-	●
AMG door sill panels in brushed stainless steel	-	●
AMG radiator grille with chrome-trimmed twin louvre, chrome-trimmed grid and AMG logo	-	●

Item	G 350 d	Mercedes-AMG G 63
AMG sports exhaust system with two chrome-trimmed twin tailpipes, left and right	-	●
Bumpers - painted in body colour, front and rear	●	●
Differential locks (transfer case, front and rear axle)	●	●
Door mirrors - electrically adjustable and heated Integrated indicators, front area lighting and automatically dimming driver's mirror	●	●
Electric steel sunroof - tilting/sliding, with one-touch opening	○	●
Front fog lamps with integral cornering light function	●	-
Headlamps - bi-xenon, with automatic range adjustment and cleaning system	●	●
LED daytime running lamps	●	●
Low range gear reduction (electronically selectable while driving)	●	●
Obsidian black exterior trim highlights (mirrors, roof, front and rear bumpers, fender flares and spare wheel cover) only in conjunction with the Colour Edition	-	●
Parking Guidance with PARKTRONIC	●	●
Privacy glass - dark glass from B-pillar backwards	●	●
Radiator grille with three-louvre design	●	-
Rain-sensing wipers	●	●
Rear lamps - LED-look	●	●
Reversing camera	●	●
Tow bar	●	●



Item	G 350 d	Mercedes-AMG G 63
Interior		
12V sockets in front passenger footwell, rear and load compartment	●	●
AMG instrument cluster with colour display (TFT technology)	-	●
Ambient lighting	●	●
Automatically dimming rear-view mirror	●	●
Centre armrest between front seats with integrated stowage compartment	●	●
Cup holders – front and rear	●	●
Dashboard – leather-covered	●	●
Electric windows (4)	●	●
Front seats – heated and electrically adjustable Memory function for seats, head restraints, exterior mirrors and steering wheel	●	●
Instrument cluster with colour display (TFT technology)	●	-
Interior contrast stitching matching the exterior paint colour (seats, dashboard, centre console, handbrake, upper door panel edge and grab handle) only in conjunction with the Colour Edition	-	●
Luggage compartment cover	●	●
Luggage protection net	●	●
Rear bench seat – split folding 1/3:2/3	●	●
Rear seats – heated	●	●
Seat belts, 3-point design (4)	●	●
Seat belt pre-tensioners (4)	●	●

Item	G 350 d	Mercedes-AMG G 63
Seat Comfort package Ventilated multi-contour front seats	-	●
THERMATIC – automatic climate control	●	●
Twin bottle holder in rear	●	●
Steering		
Multi-function AMG performance steering wheel and AMG gearshift lever trimmed in nappa leather	-	●
Multi-function steering wheel and gearshift lever in nappa leather	●	-
Steering column – electrically adjustable, with automatic adjustment for entry/exit	●	●
Paint, Trim and Upholstery		
Paint – metallic	●	●
Roof lining – designo black DINAMICA microfibre	-	●
Roof lining – grey	●	-
Trim – anthracite poplar wood	●	-
Trim – designo black piano lacquer	○	●
Upholstery – leather	●	-
Upholstery – designo leather	○	●





Item	G 350 d	Mercedes-AMG G 63
Safety and Assistance Systems		
AMG high-performance braking system	-	●
Airbags - driver and front passenger	●	●
Airbags - front side	●	●
Airbags - windowbags	●	●
Anti-lock braking system (ABS) with Brake Assist (BAS)	●	●
Anti-theft alarm system with tow-away protection and interior motion sensor	●	●
Electronic Brake Force Distribution (EBV)	●	●
Electronic Stability Programme (ESP®) with Acceleration Skid Control (ASR)	●	●
Four-wheel Electronic Traction System (4ETS)	●	●
Headlamp Assist - automatic headlamp activation	●	●
ISOFIX child seat fixing points in rear (two outer seats)	●	●
Service indicator ASSYST	●	●
Tyre pressure monitoring system	●	●

Item	G 350 d	Mercedes-AMG G 63
Communications and In-Car Entertainment		
Bluetooth® interface for hands-free telephony	●	●
Central controller dial to operate audio functions and telephone (when connected)	●	●
COMAND Online system with Media Interface Includes radio, single CD, 7-inch colour display, hard disk drive (HDD) navigation with 3D map display and TMC (Traffic Message Channel), Speed Limit Assist, LINGUATRONIC voice control in centre console and in-car internet access (internet-enabled mobile phone required). Also includes SD memory card slot, 10 GB music register and MP3 compatibility. Media Interface allows connection and control of portable media devices (e.g. MP3 player, USB storage media). Cables included for aux-in, USB or iPod® connectivity	●	●
DAB digital radio tuner	●	●
Surround sound system - Harman Kardon® Logic 7® with Dolby Digital 5.1 and DTS 12 high-performance speakers and additional amplifier	●	●



A revolution in style

Item	Notes				Basic RRP excl. VAT (£)	Total RRP incl. VAT (£)
Wheels						
18" alloy wheels (4) – 5-twin-spoke design 265/60 tyres			RM9	●	-	-
19" alloy wheels (4) – 5-twin-spoke design, matt black 275/55 tyres	Included with Sports Styling package (code SPT). Please refer to page 38 for more information.		RK5	△	-	Included in Sports Styling package
20" AMG alloy wheels (4) – 5-twin-spoke design, burnished titanium grey high-sheen finish 275/50 tyres			R10	-	●	-



> View offers





Book a > test drive > AMG test drive



> Find a Retailer



> View the Range Guide

Item	Notes		G 350 d	Mercedes-AMG G 63	Basic RRP excl. VAT (£)	Total RRP incl. VAT (£)
Wheels (continued)						
20" AMG alloy wheels (4) – 5-spoke design, painted matt black, high-sheen finish 275/50 tyres	Silver brake calipers available with galactic beam (code 4171) and tomato red (code 3150)		R11	- ○	829.17	995.00
21" alloy wheels (4)- 5-twin-spoke design, painted black 295/40 tyres	Available exclusively on Mercedes-AMG G 63 EDITION 463		R12	- △	-	-
21" bicolour alloy wheels (4)- 5-twin-spoke design, painted black 295/40 tyres	Available exclusively on Mercedes-AMG G 63 EDITION 463		R13	- △	-	-

● Standard ○ Optional - Not available △ Available as part of an option package or special edition



Sports Styling package



Running boards left and right



Radiator grille with chrome inserts



Stainless steel spare wheel cover with 3D star



19" 5-twin-spoke alloy wheels painted in matt black

The Sports Styling package contains eye-catching design features for both the exterior and interior.

Sports Styling package – designed and priced as a package, including items as listed below.

G 350 d

Total incl. VAT £2,995.00

Sports Styling package (code SPT)

19" 5-twin-spoke alloy wheels painted in matt black

Additional chrome trim elements around wooden fascia for seat adjustment, around the front door loudspeaker grilles and gearshift lever frame

Black velour floor mats

Chrome load sill protector with 'Mercedes-Benz' lettering

Radiator grille with chrome inserts

Running boards left and right

Spare wheel cover in stainless steel with three-dimensional Mercedes-Benz star



Driving Assistance package



Blind Spot Assist

Blind Spot Assist utilises short-range radar sensors to monitor the vehicle’s blind spot. If the system detects a vehicle in the blind spot, a red triangle lights up in the respective exterior mirror to alert the driver.

DISTRONIC PLUS is a proximity control system which extends the functionality of the conventional cruise control with variable speed limiter by adding automatic control of the distance to the vehicle ahead.



DISTRONIC PLUS

Driving Assistance package – designed and priced as a package, including items as listed below.

G 350 d and Mercedes-AMG G 63 Total incl. VAT £2,495.00

Driving Assistance package (code DAP)

Blind Spot Assist

DISTRONIC PLUS



Entertainment package



The rear seat entertainment system offers all rear passengers entertainment of a high technical standard. During the journey, rear passengers can watch DVDs by means of the DVD players integrated in the displays or use external entertainment devices such as game consoles. Each screen works independently from the other or content can be played simultaneously.

The TV tuner¹ makes it possible to receive digital terrestrial channels around the world, plus Teletext access, a choice of up to 30 channels, audio playback through speaker and playback through front COMAND screen up to approx. 4 mph.

Entertainment package – designed and priced as a package, including items as listed below.

G 350 d and Mercedes-AMG G 63 Total incl. VAT £2,995.00

Entertainment package (code ENT)

Rear seat entertainment system

TV tuner

¹TV tuner plays through front COMAND screen only



> View offers



Book a > test drive > AMG test drive



> Find a Retailer



> View the Range Guide

Winter package



Fuel-fired auxiliary heater



Heated windscreen

A fuel-fired heater that operates independently of the engine can be set to heat or ventilate the interior by remote control or by programming the departure time.

The heated windscreen function enables the windscreen to be easily defrosted, or the windscreen and side windows to be demisted, at the touch of a button.

Winter package – designed and priced as a package, including items as listed below.

G 350 d and Mercedes-AMG G 63 Total incl. VAT £1,750.00

Winter package (code WNT)

Auxiliary heater

Heated windscreen

[View offers](#)[Book a test drive](#) [AMG test drive](#)[Find a Retailer](#)[View the Range Guide](#)

Pricing summary for packages

Model	Transmission	Recommended OTR price (£) ¹				
			Sports Styling package	Driving Assistance package	Entertainment package	Winter package
G 350 d	7G-TRONIC PLUS 7-speed automatic	87,815.00	90,810.00	90,310.00	90,810.00	89,565.00
Mercedes-AMG G 63	AMG SPEEDSHIFT PLUS 7-speed automatic	131,695.00	-	134,190.00	134,690.00	133,445.00

¹Recommended on-the-road price: these prices reflect the Road Fund Licence applicable to the standard model plus £670.00 additional costs necessary to put your car on the road. Included are a standard UK delivery charge (£540.00 incl. VAT), new vehicle registration fee (£55.00), number plates (£25.00 incl. VAT) and fuel (£50.00 incl. VAT). VAT is calculated at the standard rate of 20%



Optional equipment

Item	Notes	Mercedes-AMG G 63			Basic RRP excl. VAT (£)	Total RRP incl. VAT (£)
		G 350 d				
AMG Performance Studio						
AMG Driver's package Includes an increase to your vehicle's electronically limited top speed (144 mph) and participation in one of the AMG BASIC-Training 'Power and Passion' events. The event is run by the AMG Driving Academy and held at a racetrack located in mainland Europe		Z09	-	○	2,079.17	2,495.00
Exterior						
AMG brake calipers, painted silver		BS1	-	○	no-cost option	
Comfort						
Exclusive package Comprising Seat Comfort package, designo black DINAMICA microfibre roof lining and illuminated door sills		PA4	○	●	2,079.17	2,495.00
Electric steel sunroof - tilting/sliding, with one-touch opening		D27	○	●	1,383.33	1,660.00
Paint, Trim and Upholstery						
designo Exclusive package designo two-tone leather in a choice of colours, AMG front sports seats, seat and door centre panels in designo leather with diamond design, upper and lower part of dashboard in designo black nappa leather	designo black ZF7 is optional on the Colour Edition	PA6	-	○	3,133.33	3,760.00
Available in: designo porcelain ZF3 designo light brown ZH2 designo classic red ZF5 designo sand ZK6 designo black ZF7 designo titan pearl ZN9						



Item	Notes			Basic RRP excl. VAT (£)	Total RRP incl. VAT (£)
		G 350 d	Mercedes-AMG G 63		
Paint, Trim and Upholstery (continued)					
Paint – designo metallic paint finishes Available in: designo mocha black 033 designo graphite 041 designo platinum black 046		'	○ ○	1,220.83	1,465.00
Paint – designo mystic paint finishes Available in: designo mystic blue 032 designo mystic red 037 designo mystic brown 052		'	○ ○	1,975.00	2,370.00
Paint – designo magno paint finishes Available in: designo magno platinum 051 designo magno night black 056	Magno matt paint finishes require extra care. Please ask your Retailer for further details	'	○ ○	3,570.83	4,285.00
Trim – AMG carbon fibre Standard on Mercedes-AMG G 63 Colour Edition and EDITION 463	With wood- and leather-trimmed steering wheel in designo black piano lacquer/black nappa leather	ZG6+ZT1	○ –	4,525.00	5,430.00
			– ○	3,045.83	3,655.00
	With heated nappa leather-trimmed steering wheel	ZG6+VL0	○ –	3,841.67	4,610.00
			– ○	3,045.83	3,655.00
	With AMG performance steering wheel	ZG6	– ○	3,045.83	3,655.00
Trim – anthracite poplar wood	With heated nappa leather-trimmed steering wheel	VL0	○ –	229.17	275.00



> View offers



Book a > test drive > AMG test drive



> Find a Retailer



> View the Range Guide

Optional equipment

45

Item	Notes	G 350 d Mercedes-AMG G 63		Basic RRP excl. VAT (£)	Total RRP incl. VAT (£)
Paint, Trim and Upholstery (continued)	Trim – designo black piano lacquer	ZG2+ZT1	○ –	2,091.67	2,510.00
			– ○	no-cost option	
	With heated nappa leather-trimmed steering wheel	ZG2+VL0	○ –	1,391.67	1,670.00
			– ○	no-cost option	
	With AMG performance steering wheel	ZG6	– ●	–	–
	Trim – brown burr walnut wood, high-gloss	Includes wood- and leather-trimmed steering wheel in high-gloss brown burr walnut wood/black nappa leather	V56+VK1	○ –	870.83
			– ○	no-cost option	
Trim – designo champagne white piano lacquer	With nappa leather-trimmed steering wheel	ZG8	○ –	1,395.83	1,675.00
			– ○	no-cost option	
	With heated nappa leather-trimmed steering wheel	ZG8+VL0	○ –	1,625.00	1,950.00
			– ○	no-cost option	
With AMG performance steering wheel	ZG8	– ○	no-cost option		
Trim – designo light brown poplar wood Includes steering wheel in black nappa leather	With nappa leather-trimmed steering wheel	ZT0	○ –	1,395.83	1,675.00
			– ○	no-cost option	
	With heated nappa leather-trimmed steering wheel	ZT0+VL0	○ –	1,625.00	1,950.00
			– ○	no-cost option	
With AMG performance steering wheel	ZT0	– ○	no-cost option		

● Standard ○ Optional – Not available



> View offers



Book a > test drive > AMG test drive



> Find a Retailer



> View the Range Guide

Optional equipment

46

Item	Notes	Mercedes-AMG G 63			Basic RRP excl. VAT (£)	Total RRP incl. VAT (£)
Paint, Trim and Upholstery (continued)						
Upholstery – leather		1	○	–	no-cost option	
Available in: black SP3 alpaca grey SP4 chestnut SP5						
Upholstery – designo leather		1	○	–	1,333.33	1,600.00
Available in: designo porcelain ZF3 designo marron ZF4 designo classic red ZF5 designo black ZF7 designo light brown ZH2 designo sand ZK6 designo mystic red ZK8 designo titan pearl ZN9			–	●	no-cost option	

● Standard ○ Optional – Not available



> View offers



Book a > test drive > AMG test drive



> Find a Retailer



> View the Range Guide

Optional equipment

47

Item	Notes			G 350 d Mercedes-AMG G 63	Basic RRP excl. VAT (£)	Total RRP incl. VAT (£)
Service Package						
Service Care Service Care allows you to spread the cost of servicing your new car in the Mercedes-Benz Retailer network. Taking out a Service Care plan ensures your servicing needs are taken care of by fully trained Mercedes-Benz Technicians with the added benefit of a Mercedes-Benz service history	Price is based on a monthly rate. Example given is for two services taken over 24 months, three services over 36 months or four services over 48 months. Further payment options are available. New Service Care prices apply only to vehicles up to 12 months old prior to first service. Prices correct up to 30 April 2016	1	○	-	42.50	51.00
			-	○	45.83	55.00

● Standard ○ Optional - Not available



Colours and materials

Metallic paints

Standard



183 magnetite black



775 iridium silver



197 obsidian black



792 palladium silver



300 periclase green



796 citrine brown



359 tanzanite blue



963 indium grey



541 thulite red



988 diamond silver



755 tenorite grey

Non-metallic paints

No-cost option



040 black

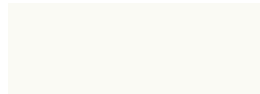

149 polar white

Special metallic paints

Additional-cost option



032 designo mystic blue



052 designo mystic brown



033 designo mocha black



056 designo magno night black



037 designo mystic red



041 designo graphite

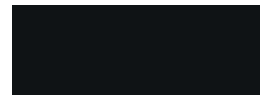

046 designo platinum black



051 designo magno platinum

Colour Edition metallic paints



3150 tomato red



6166 alien green



4171 galactic beam



1278 sunset beam



2173 solar beam

Please note that, owing to limitations of on-screen representation, paint colours may differ from those shown



Trim



Z1 anthracite poplar wood¹



V56 brown burr walnut wood (high-gloss)^{3,4}



ZG6 AMG carbon fibre⁵



ZG2 designo black piano lacquer^{2,3}



ZG8 designo champagne white piano lacquer^{3,4}



ZT0 designo light brown poplar (satin finish)^{3,4}

Upholstery – leather

Standard on G 350 d



SP3 black



SP4 alpaca grey



SP5 chestnut

designo leather

Standard on Mercedes-AMG G 63

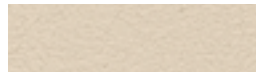

ZF3 designo porcelain



ZH2 designo light brown



ZF4 designo marron



ZK6 designo sand



ZF5 designo classic red



ZK8 designo mystic red



ZF7 designo black



ZN9 designo titan pearl

designo two-tone leather

Standard on EDITION 463



ZF3 designo porcelain



ZF7 designo black

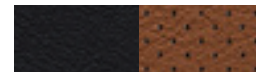

ZH2 designo light brown

designo leather

Standard on Colour Edition



1278 solar beam



2173 sunset beam



3150 tomato red

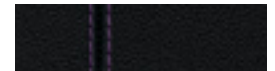

4171 galactic beam



6166 alien green

¹Standard on G350 d ²Standard on Mercedes-AMG G 63 ³Optional for G350 d ⁴No-cost option for Mercedes-AMG G 63 ⁵Optional; standard on Mercedes-AMG G 63 EDITION 463 and Colour Edition



Combination options

Leather		Metallic paints											Non-metallic paints	
		183 magnetite black	197 obsidian black	300 periclase green	359 tanzanite blue	541 thulite red	755 tenorite grey	775 iridium silver	792 palladium silver	796 citrine brown	963 indium grey	988 diamond silver	040 black	149 polar white
	black	●	●	●	●	●	●	●	●	●	●	●	●	
	alpaca grey	●	●	●	●	●	●	○	○	●	○	●	●	
	chestnut	●	●	○	●	○	●	●	●	○	○	●	●	



Technical data

	Diesel engine	Petrol engine
Model	G 350 d	Mercedes-AMG G 63

Engine		
Total displacement	cc	2,987
Arrangement/cylinders/valves		V/6/24
Power ¹	hp (kW) at rpm	245 (180)/3,600
Torque ¹	Nm at rpm	600/1,600–2,400

Transmission		
7G-TRONIC PLUS 7-speed automatic	●	-
AMG SPEEDSHIFT PLUS 7G-TRONIC 7-speed auto.	-	●

Performance		
Acceleration 0–62 mph	sec	8.9
Top speed	mph	119



	Diesel engine	Petrol engine
Model	G 350 d	Mercedes-AMG G 63

Weights and capacities

Kerb weight	kg	2,612	2,550
Perm. Gross Vehicle Weight	kg	3,200	3,200
Towing capacity – unbraked braked	kg	3,500 750	3,500 750
Boot capacity Seats down Seats up	l	2,126 699	2,250 480
Fuel tank capacity/of which reserve	l	96/14	96/14
Turning circle kerb to kerb	m	13.6	13.6
Wading depth	mm	600	600

Fuel consumption^{2,3}

mpg

Urban	25.5	16.4
Extra-urban ⁴	31.0	23.9
Combined	28.5	20.5



	Diesel engine	Petrol engine
Model	G 350 d	Mercedes-AMG G 63
CO₂ emissions³	g/km	
Emissions standard	EU6	EU6
Standard wheels	261	322

Insurance

Insurance ratings may vary depending on model specification. Please refer to <http://www.thatcham.org/abigrouprating/> for further details

¹Figures according to Directive 80/1269/EEC in the currently applicable version

²All figures are based on a standard specification with the smallest tyre size

³The choice of wheels and transmission may affect CO₂ emissions and corresponding Road Fund Licence

⁴EUDC: extra-urban driving cycle. Testing procedures adhere to EU Directive 93/116

The figures on pages 51-55 are correct at time of publication. Please refer to the government website for latest data - <http://carfueldata.direct.gov.uk/>



> View offers



Book a > test drive > AMG test drive



> Find a Retailer



> View the Range Guide

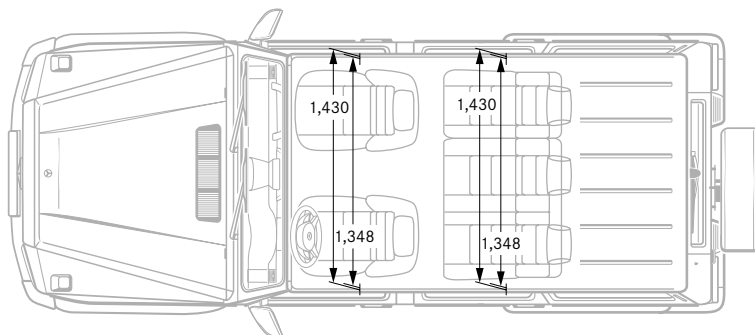
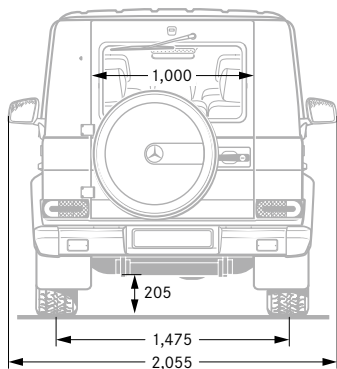
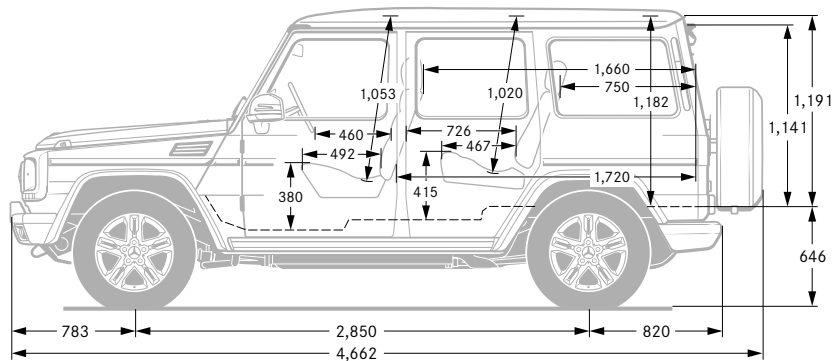
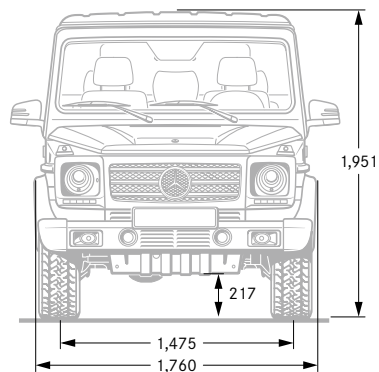



> View offers



Book a > test drive > AMG test drive



> Find a Retailer



> View the Range Guide

Off-road capability

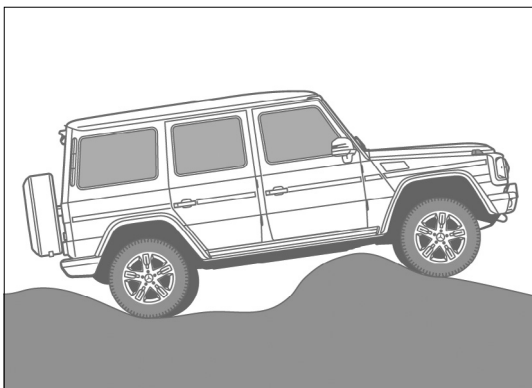

Large ramp breakover angle of 24°

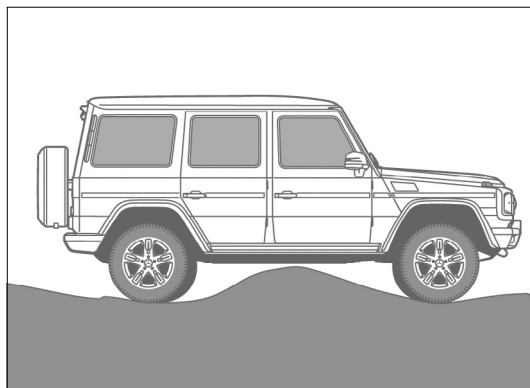

Ground clearance of 21 cm (22 cm on Mercedes-AMG G 63)

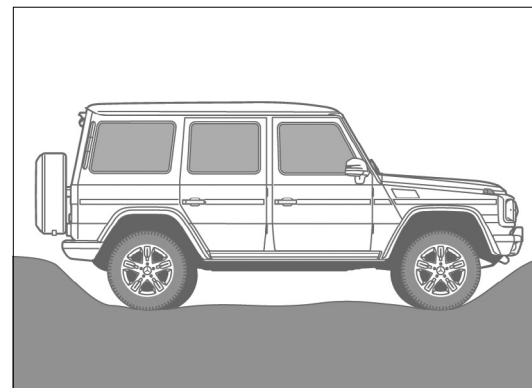

Max. approach angle 36°¹; max. departure angle 27°

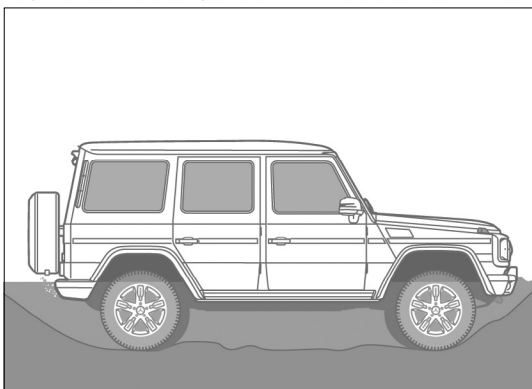

Maximum fording depth of 60 cm

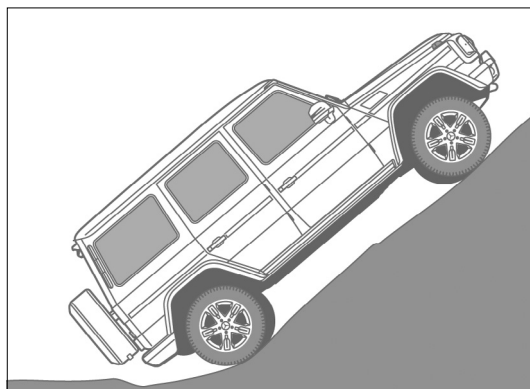

Climbs gradients of up to 80% (surface permitting)

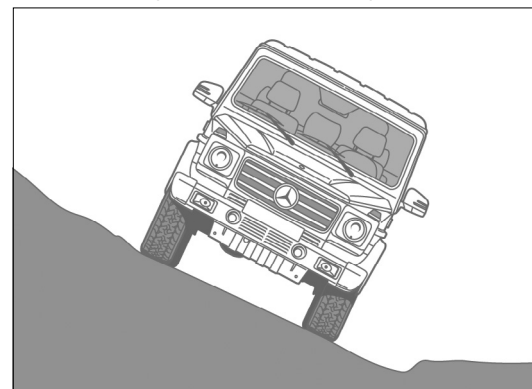

Directionally stable on slopes of up to 54%

¹27° for Mercedes-AMG G 63



> View offers



Book a > test drive > AMG test drive



> Find a Retailer



> View the Range Guide

Road Fund Licence



All road vehicle registrations are subject to Vehicle Excise Duty (Road Fund Licence), which varies in accordance with the vehicle's CO₂ emissions. A first year rate of Vehicle Excise Duty applies to new cars on their first year of registration. For the second and subsequent years a standard rate for each taxation band will apply.¹ The table below shows the bands (A–M) created by the DVLA and the corresponding Road Fund Licence. CO₂ emissions are listed in the technical data on page 53, and the relevant Excise Duty is reflected in the on-the-road prices on page 17.

Band	CO ₂ emissions	First year rate (£)	Standard rate (£)
A	up to 100 g/km	0.00	0.00
B	101 to 110 g/km	0.00	20.00
C	111 to 120 g/km	0.00	30.00
D	121 to 130 g/km	0.00	110.00
E	131 to 140 g/km	130.00	130.00
F	141 to 150 g/km	145.00	145.00
G	151 to 165 g/km	185.00	185.00
H	166 to 175 g/km	300.00	210.00
I	176 to 185 g/km	355.00	230.00
J	186 to 200 g/km	500.00	270.00
K	201 to 225 g/km	650.00	295.00
L	226 to 255 g/km	885.00	500.00
M	over 255 g/km	1,120.00	515.00

¹For further information on vehicle taxation please refer to <http://carfueldata.direct.gov.uk/>



Services and insurance

Mercedes-Benz Service

To get the best out of your car and to keep it running as our Mercedes-Benz engineers intended, we recommend that you have your G-Class maintained and serviced at regular intervals at any one of our Mercedes-Benz Official Workshops.

Some of the benefits of visiting a Mercedes-Benz Official Workshop include:

- A dedicated Service Team Manager
- Access to Mercedes-Benz trained Technicians
- The use of Mercedes-Benz Genuine Parts
- Free service measure updates
- Fixed pricing – you will always know the cost before any work is undertaken
- Total convenience – whether you need your vehicle picking up from home or want to wait in our lounge
- An up-to-date Mercedes-Benz service record

To receive a personalised Service Care plan recommendation visit the Service Care Calculator at servicecarerates.mercedes-benz.co.uk

Warranty and breakdown cover

Every Mercedes-Benz comes with a three-year unlimited mileage warranty against manufacturing or material defects¹ and up to 30 years warranty against perforation due to corrosion from the inside out.² What's more, it's also covered by Mercedes-Benz Roadside Assistance – a unique package comprising up to 30 years pan-European breakdown assistance.²

Insurance

Since our name is synonymous with reliability, who better to trust with your motor insurance? Mercedes-Benz Insurance provides a motor insurance policy specifically designed to give you the cover you would expect from Mercedes-Benz. For a motor insurance quotation, call **0345 600 2180**.*

Mercedes-Benz Finance

Why should you finance with Mercedes-Benz?

At Mercedes-Benz we believe a great driving experience should be matched by an equally great ownership experience. That is why we put just as much thought, time and effort into designing our finance options, our service plans and our insurance cover as we do into our vehicles.

We are not in the business of simply providing a loan to fund the purchase of your dream vehicle. We look on it as a journey that we take with you, from the moment you choose your new Mercedes-Benz, to helping you in choosing your next one.

If you would like to find out more about any of our current offers, simply call into your local Mercedes-Benz Retailer where one of our Business Managers will be more than happy to talk you through anything you need to know.

Helping you find the right solution.

You should find our finance packages are more convenient than a traditional personal loan because:

- Funds are immediately available – no waiting for cheques or loans to clear.
- There is no security required – either against your home or other assets.
- We have clear and transparent rates – the APR we quote is the APR you get.
- We have friendly Business Managers – experts in vehicle finance who can talk you through all of your plans in detail.

One of our most popular finance products is Mercedes-Benz Agility (our Personal Contract Purchase product). We also offer Contract Hire, Operating Lease and Hire Purchase solutions. If you would like to find out more about these speak to your Retailer or visit www.mercedes-benz.co.uk/fandi.

Mercedes-Benz Agility (our PCP product).

At the start of an Agility agreement, you put down a deposit and decide the term of your agreement and your annual mileage. You will be advised of the Guaranteed Future Value, which offers you the reassurance of knowing exactly what you will need to pay to own the vehicle outright in the future (this is known as the Optional Purchase Payment).

Throughout your agreement you simply pay your agreed monthly payments and when the agreement comes to an end you either purchase, hand back or part-exchange your vehicle.





Agility features:

- Fixed regular payments mean you can easily budget.
- Payments are based only on a proportion of the vehicle's value, keeping your monthly payments lower.
- Our Guaranteed Future Value avoids the risk of unplanned depreciation of your vehicle.
- You defer your ownership decision until the end of the agreement.

At the end of your agreement you have three options to choose from.

Option 1: Purchase your Mercedes-Benz.

Purchase your Mercedes-Benz by paying the Optional Purchase Payment and Purchase Activation Fee.¹ This will complete the purchase of your Mercedes-Benz, leaving you free to simply enjoy your vehicle.

Option 2: Hand back your Mercedes-Benz.

If you decide to return your vehicle to us, it must be in line with our Vehicle Return Standards,* as vehicle condition, excess mileage and other charges may be payable.

Option 3: Part-Exchange for a new vehicle.

Purchase your Mercedes-Benz by paying the Optional Purchase Payment and Purchase Activation Fee.¹ This will complete the purchase of your Mercedes-Benz, leaving you free to part-exchange for a new vehicle.

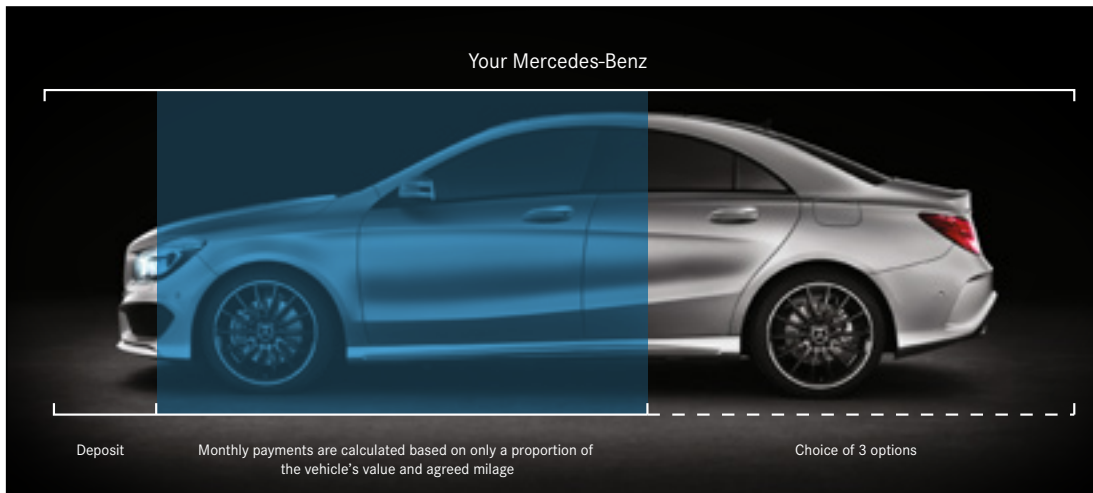

¹Please note the 'Purchase Activation Fee' of £10 will be debited from your account *To find out more information about our Vehicle Return Standards please visit <http://mercedes-benz.co.uk/vrs>



> View offers



Book a > test drive > AMG test drive



> Find a Retailer



> View the Range Guide

Follow us on the following social media channels:



<https://www.facebook.com/MercedesBenzUk>



<https://twitter.com/mercedesbenzUK>



<https://www.youtube.com/mercedesbenzUK>



<https://instagram.com/mercedesbenzUK>

Effective from 1 April 2016. Information correct at time of publication.

Prices and specifications are subject to change without prior notice.

MBW463PL/0416

Mercedes-Benz UK Ltd, Tongwell, Milton Keynes, MK15 8BA www.mercedes-benz.co.uk