



THE ELISE

LOTUS

LOTUS ELISE

CONTENTS



A UNIQUE PLACE IN HISTORY	4-5
LOTUS RACING BACK ON TRACK	6-7
PERFORMANCE THROUGH LIGHTWEIGHT	8-9
BUILT IN PERFORMANCE	10-11
SUPERIOR ON TRACK	12-13
SPIRITED ON THE ROAD	14-15
ALIVE IN THE CITY	16-17
THE LOTUS ELISE	22-23
THE LOTUS ELISE CR	24-25
THE LOTUS ELISE S	26-27
FEATURE FOCUS	28-29
COCKPIT INTERIOR	30-31
BODY COLOURS	34-35
INTERIOR STYLE	36-37
EXTERIOR WHEELS	38
OPTION PACKS	39
TECHNICAL SPECIFICATION	40-42
LOTUS LIFE	43
FURTHER INFORMATION	44

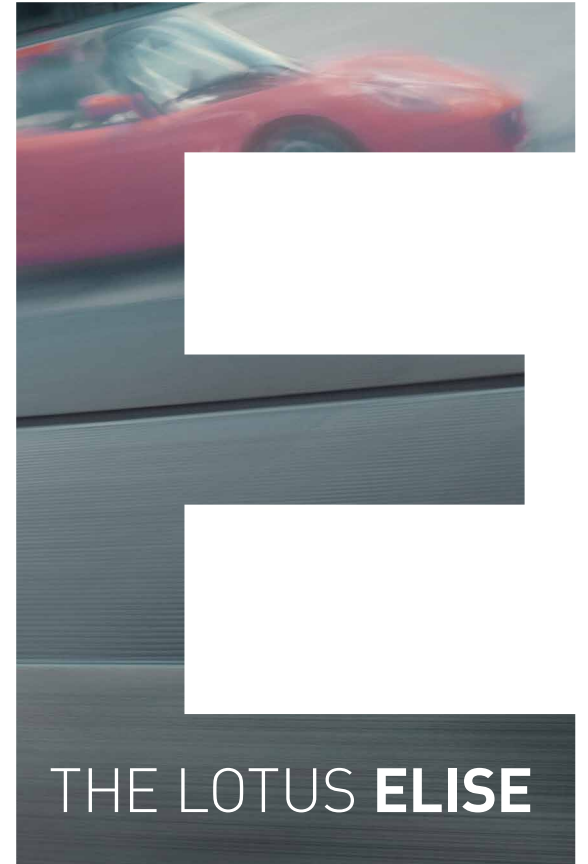

THE LOTUS ELISE

A UNIQUE PLACE IN HISTORY



Lotus is a driving icon that throughout decades of development has remained true to its founding principles; from the original Elite to the latest Evora. Efficient use of the minimum number of parts, a perfectly balanced chassis and a tactile and involving spirit are recognisable in every car to carry the Lotus badge.

In 1948 Colin Chapman built his first car, following his own theories for improved performance. He formed Lotus in 1952 and from then on the company has never ceased to innovate. In competition, Lotus has a rich history. In Formula 1 alone Lotus has more than 475 Grand Prix starts, complete with 79 victories and 7 World Championships. In addition to the accolades gained in F1, Lotus has successfully competed in Rally, Le Mans, Indy and saloon car classes around the world.

Chapman was a pioneer in creating lightweight cars, his innovations changed the face of racing car design forever. From the introduction of 'ground effect', aerofoil wings, monocoque chassis and active-ride suspension through to the aluminium bonded chassis of the modern line up, Lotus have never stopped inventing and the passion for innovation remains at the core of everything they do today.



FIA Formula 1 Constructors' World Championships



FIA Formula 1 Drivers' World Championships



FIA Formula 1 Grand Prix Wins



Le Mans Wins (in Class)



Indianapolis 500 Win



FIA World Rally Championship

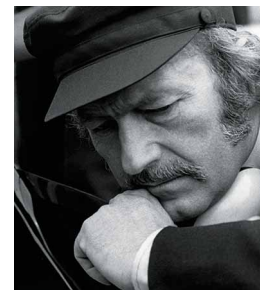

Above: Founder Colin Chapman.
Left: 1970, the British Grand Prix was won by Rindt's Lotus 72.
Right: 1972, Fittipaldi in the iconic black and gold livery debriefs Chapman.

“If you're not winning, you're not trying.”

Colin Chapman

LOTUS RACING BACK ON TRACK

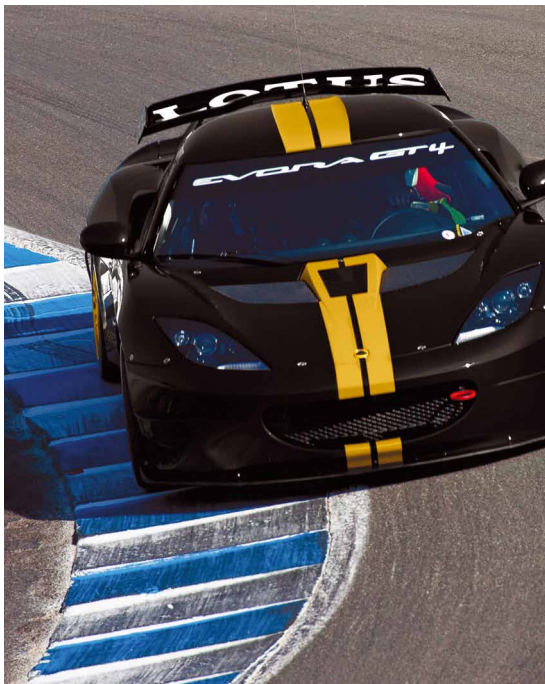

Left: Evora GT4
Below: LMP2 Car
Bottom: Evora GTE
Right: 2012 Lotus F1 Car at the Australian Grand Prix



For Lotus, motorsport is tradition, inspiration and the cornerstone of its brand. Colin Chapman inspired Lotus' racing success and applied his engineering genius to make Lotus cars technically innovative and ultimately faster than the competition.

As ambitious now as in the past, this dedication to motorsport continues with Lotus gearing up in competitions around the world. In Formula 1, Endurance racing and numerous GT series, Lotus is up to speed; from Silverstone to Le Mans to Monaco, Lotus is making an impression in the world's most famous events on the most demanding circuits. These high-profile international events are complimented by dedicated Lotus one-make race series for the Evora and Elise.

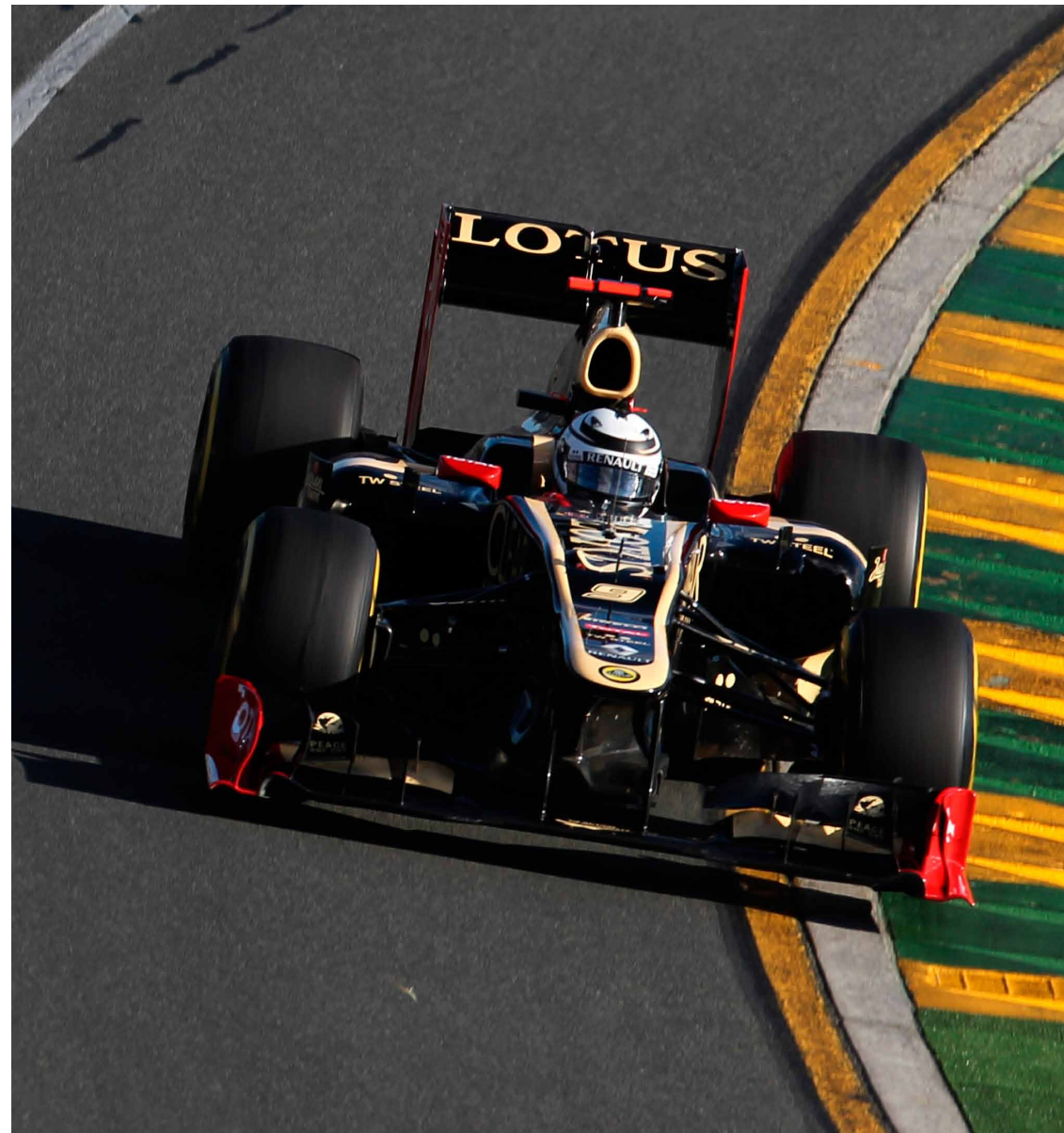

PERFORMANCE THROUGH LIGHTWEIGHT

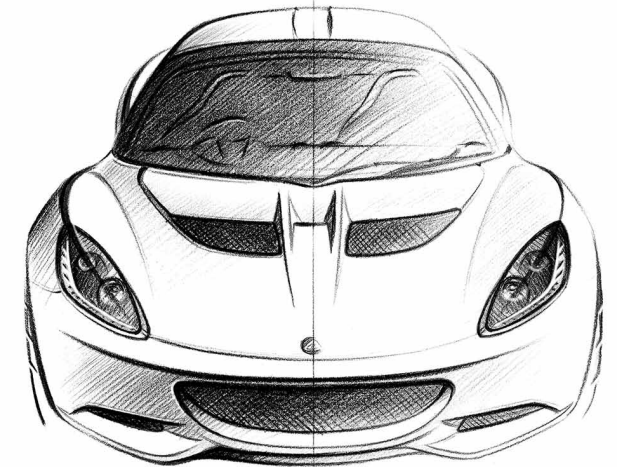

Colin Chapman constructed a series of aerodynamically advanced, lightweight sports racing cars during the 1950s - typified by the Lotus Eleven that won its class at Le Mans in 1957. Often quoted, though still as valid today as when he first uttered the words at the launch of the Lotus Seven in 1957, Chapman's ethos was - "to increase performance, add lightness".

His engineering ideals endure in the Lotus Elise, with few cars rivalling its tactile agility. A mid-engined, rear-wheel drive with an ultra-responsive chassis, utilising lightweight materials such as aluminium and composite deliver the ultimate driving sensation, providing phenomenal feedback with surefooted handling.

A reputation as a true driver's car combined with low CO₂ emissions mean the Elise is the perfect sports car for today's roads.

BUILT IN PERFORMANCE



Above: Attention to detail
Right: Elise bodywork ready for paint
Bottom: Finishing touches
Far Right: The award winning Elise chassis

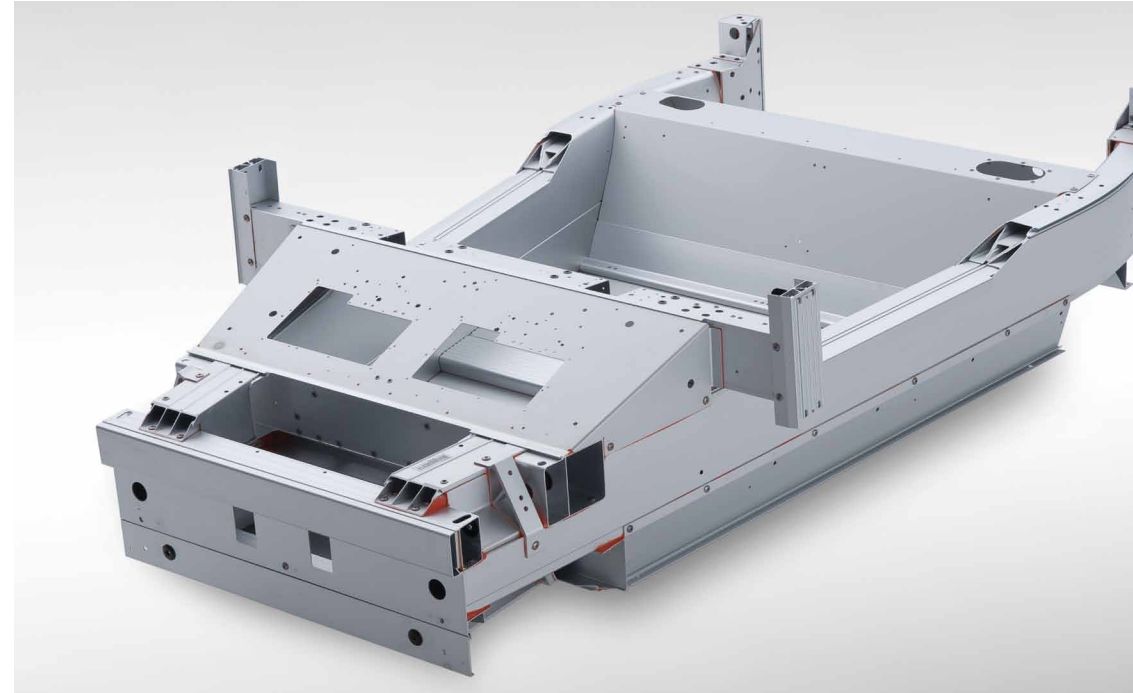

The name Lotus is synonymous with sublime handling and poised vehicle dynamics around the world. The Elise leads the way with its lightweight, state-of-the-art, extruded and bonded aluminium chassis, allied to motorsport derived wishbone suspension with body panels made from lightweight composite. Its unique design ensures an extremely rigid chassis, and the perfect foundation for an agile sports car.

Production combines high technology processes with hand finishing techniques, from chassis construction through to final assembly. Teams of specialists oversee every process ensuring Lotus' high-quality engineering standards are met. With engineering effectiveness comes efficiency, allowing Lotus to extract every aspect of dynamic performance from each component – remaining true to Chapman's original principle of performance through lightweight.

SUPERIOR ON TRACK



A Lotus Elise is like a 'glove on the hand', a second skin channelling feedback into your hands and feet via the steering wheel and the pedals. Designed to deliver, it inspires confidence with precision control, perfect balance and pedigree dynamics. From its functional aerodynamics, to its mid-engined construction with optimum weight distribution, through to its race-derived components, such as Bilstein dampers, Eibach springs and track tuned braking system - the Elise's dynamic intent is clear.

Proof of its prowess is the Lotus Cup race series: the Elise is as much at home on the circuit as it is on rural roads. It tracks superbly, sticking tight to the tarmac as you establish a rhythm and flow through the turns. But you'd expect that given its evolution at the famous Hethel test track.





SPIRITED ON THE ROAD

Since its launch, the Elise has been hailed as one of the best sports cars that money can buy, creating perfect harmony between driver and machine. The latest generation to carry the evocative name retains the supple road holding, fluid dynamics and tactile feedback of the original and combines this with efficient performance and economy.

Its compelling agility is a given. The incredibly lightweight and stiff chassis and finely tuned wishbones and dampers, allied to Lotus DPM (Dynamic Performance Management) and sticky Yokohama tyres provide absolute handling precision. No other sports car tackles the open road with the verve of an Elise, where every driver input has such a clear and measurable effect on the car's behaviour.



Offering wind-in-the-hair motoring in its purest form, the Elise's personality can be quickly modified to suit your mood, with its character defining soft top and optional hard top ensuring driving thrills across all seasons.

ALIVE IN THE CITY



The Elise handles the transition from open-road to urban grind with consummate ease. Its compact dimensions make navigating narrow city roads easy, and its distinctive styling ensures plenty of on-road presence.



Due a dose of retail therapy? You'll be surprised how accommodating the rear stowage area is. While its unique combination of supercar looks and performance coupled with its low running costs and CO₂ emissions of just 149 g/km in the standard Elise make it an exciting alternative for the city, bringing some fun to your everyday commute.



SERIOUS
FUN



PERFORMANCE
ART



THE LOTUS ELISE



The Elise is a pure-bred sports car, offering exhilarating top-down motoring at an affordable price. Power is provided by an eager 1.6-litre engine, a lightweight in-line four, producing 134 hp with impressive CO₂ emissions of just 149 g/km. In simple terms, supercar performance combined with city car economy.

The key to this superb balance of engine performance and efficiency is the Valvematic system, a variable valve lift mechanism which combines with dual VVT-i technology. The engine continuously controls valve timing and lift to vary the volume of airflow, ensuring optimal performance based on the engines operational condition. Access this performance via a 6 speed manual transmission with sports ratios.

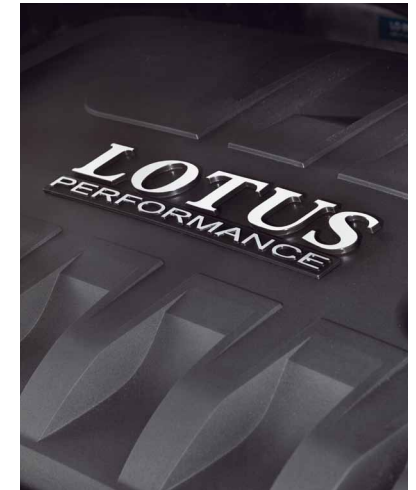

Max Power	134 hp (136 PS) at 6800 rpm
Max Torque	118 lbft (160 Nm) at 4400 rpm
0 – 60 mph	6.0 seconds
0 – 100 km/h	6.5 seconds
Max Speed	127 mph (204 km/h)
Weight	876 kg

THE LOTUS ELISE CR



With the Elise CR, Lotus has gone even further to deliver the most tactile Elise ever – without losing an ounce of style. It wasn't easy to find further areas for weight reduction in an already incredibly light car, but with a lot of attention to detail, Lotus has managed to make the Elise CR up to an amazing 24 kg lighter than the standard Elise. It's a revelation – a pure driving experience, and some of the best fun you can have on four lightweight wheels.

Powered by the same 1.6-litre engine as the standard Elise, this stripped-back racer is an uncompromised sports machine that doesn't just deliver on the road. Adjustable Eibach anti-roll bar and springs plus Bilstein sports dampers mean the Elise CR provides fingertip responsiveness on the racetrack too. Handling is assisted further with the latest Lotus Dynamic Performance Management (DPM) system, and selectable Sport setting, giving the driver ultimate power and control.

Max Power	134 hp (136 PS) at 6800 rpm
Max Torque	118 lbft (160 Nm) at 4400 rpm
0 – 60 mph	6.0 seconds
0 – 100 km/h	6.5 seconds
Max Speed	127 mph (204 km/h)
Weight	852 kg*

*Stated weight includes all weight reductions



THE LOTUS ELISE S



The latest addition to the Elise range is the new supercharged S model, delivering 217 hp and 184 lbft of torque – astonishing performance from such a lightweight car. The ultimate evolution of the Elise, its new 1.8 litre supercharged and charge cooled engine delivers instant acceleration with even more torque that's accessible from low in the rev range. Select Sport mode and DPM characteristics alter for more engagement.

Performance dynamics are matched aesthetically and aerodynamically. The impressive Elise S is distinguished by a rear wing that arches over the car's hind quarters, creating more downforce than the standard rear clamshell.

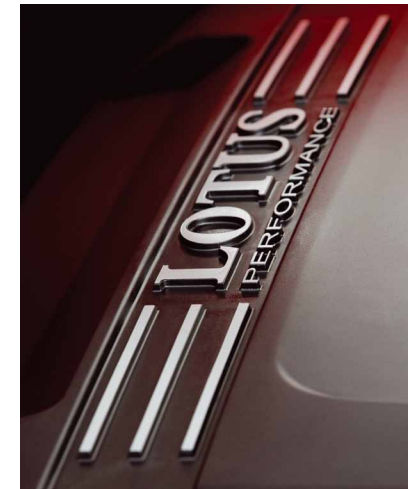

Max Power	217 hp (220 PS) at 6800 rpm
Max Torque	184 lbft (250 Nm) at 4600 rpm
0 – 60 mph	4.2 seconds
0 – 100 km/h	4.6 seconds
Max Speed	145 mph (234 km/h)
Weight	924 kg

FEATURE FOCUS



6 Speed Manual

Put yourself in complete control of the driving experience with the slick shifting 6 speed manual transmission, featuring sports ratios perfectly matched to the engine configuration and driving dynamics.



Seats

The Elise seat range has been ergonomically designed utilising light weight materials for maximum support and comfort, ensuring you stay firmly in place during spirited driving.



Rear Diffuser

The Elise' aerodynamic styling incorporates a unique rear diffuser design that both harmonises airflow underneath the rear of the car, and also provides clean and efficient lines to the underbody, with the exhaust system exiting through its middle.



Headlamps and Rear Lights

The highly distinctive headlamps incorporate hi-tech LED daylight running lights and indicators, while the rear LED brake light cluster is instantly recognisable.



Dynamic Performance Management

Lotus DPM (Dynamic Performance Management) adds to the Elise's world leading handling by offering extra stability when the high levels of grip are exceeded. A selectable Sport mode takes DPM one step further, allowing the driver to safely explore the limits further still.



Roof Options

The Elise offers exhilarating wind-in-the-hair motoring and its character defining soft-top is typically light and clever. An optional hardtop is also available for winter motoring, ensuring fun for all four seasons.



Wheels and Tyres

A range of specially selected lightweight alloy wheels subtly enhance the way your car looks and drives. These are mated to bespoke compound Yokohama AD07 tyres specifically developed to produce a tyre that works in perfect harmony with the suspension and chassis.



Elegant Detailing

Function is not at the sacrifice of form on the Elise. Wherever you look on you will find attention to detail, such as the machined aluminium petrol filler cap.

COCKPIT INTERIOR

The Elise's pure and driver focused cockpit is a special place to be. Get comfortable in the ergonomically designed sports bucket seats and grasp the small and perfectly contoured steering wheel. All controls are carefully positioned for maximum ease of use under the most demanding conditions, with nothing superficial or cosmetic distracting from the driving experience.



Aluminium features strongly, including a machined aluminium handbrake grip and gear-lever knob, as well as perfectly positioned pedals. The Elise has face-level vents that can be positioned to keep you cool with air-conditioning available as an option. And if the engine melody alone isn't enough for you, an Alpine CD receiver with iPod® and MP3 connectivity provides extra soundtracks through its 4 speaker system*.

*The Alpine CD receiver is optional on Elise CR.



LOTUS ELISE
BRITISH ICON



BODY COLOURS

STANDARD COLOURS



MOTORSPORT COLOURS

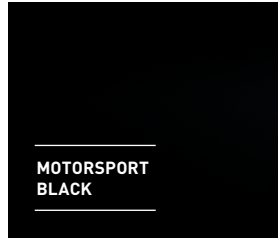

PREMIUM COLOURS

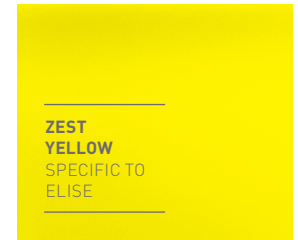
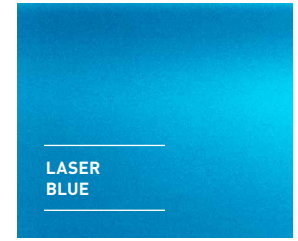
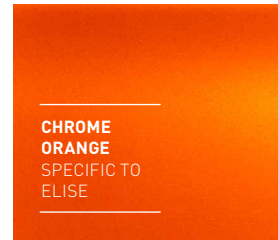

METALLIC COLOURS

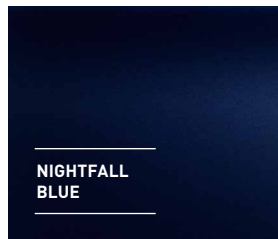
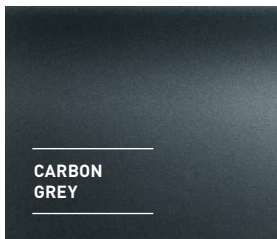

ELISE CR COLOURS

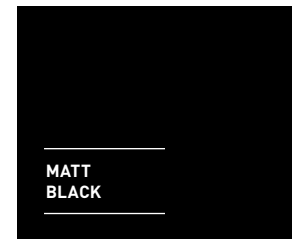
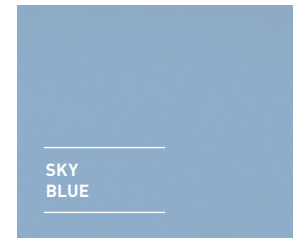
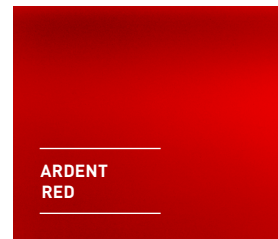

INTERIOR STYLE

Ordering an Elise is all about you, your choice, your pleasure. Whatever your favoured body colour, you can select seat upholstery and trim to match or contrast. Leather seats come in a range of dyes, and Touring and Sports Packs bring a host of extras to further individualise your Elise.



STANDARD



TOURING PACK



SPORT AND
TOURING PACK



CLUB RACER

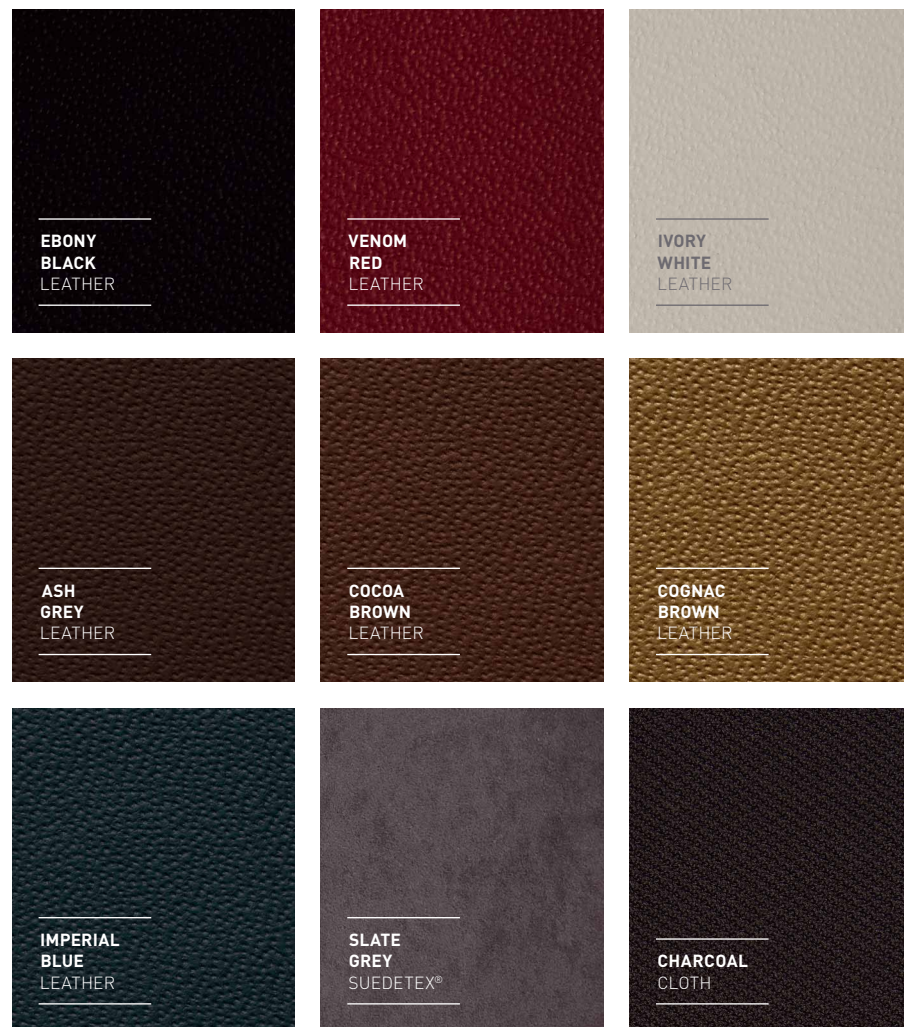

Disclaimer:
Colour swatches are for illustration purposes only and may not accurately reflect the actual colour finish of the vehicle. Please consult your Lotus dealer for accurate colour samples.

EXTERIOR WHEELS

Nothing sets off a car like a great set of wheels, and the Elise range offers six variations on the theme. Cast or forged, silver or black, there's certain to be one to suit your taste.



STANDARD WHEEL
SILVER, LIGHTWEIGHT CAST
12-SPOKE



STANDARD S WHEEL
SILVER, Y-TYPE, LIGHTWEIGHT CAST
6-SPOKE



OPTIONAL WHEEL
SILVER, FORGED
14-SPOKE



STANDARD WHEEL
SATIN BLACK, LIGHTWEIGHT CAST
12-SPOKE
(Standard on Elise CR)



STANDARD S WHEEL
SATIN BLACK, Y-TYPE,
LIGHTWEIGHT CAST
6-SPOKE



OPTIONAL WHEEL
SATIN BLACK, FORGED
14-SPOKE

OPTION PACKS

TOURING PACK (N/A to Elise CR)

Choice of leather colours: Ebony Black, Venom Red, Ivory White, Ash Grey, Cocoa Brown, Cognac Brown, Imperial Blue

Leather seats

Padded leather door panels

Perforated leather door inserts

Leather trimmed centre console

Black perforated leather handbrake lever gaiter

Black carpet mats with embroidered Elise logo

Noise insulation panelling

Auxiliary driving lights

iPod® stereo connection

Trinket tray divider and cup holder

Cruise control

SPORT PACK (N/A to Elise CR)

Bilstein sports dampers

Optional wheel, silver, forged 14-spoke (16" front and 17" rear)

Cloth sports seats (select Sport Pack and Touring Pack together and the sport seat will be trimmed in either black leather or SuedeTex®)

Sports mode for Lotus DPM

BLACK STYLE PACK (Standard on Elise CR)

Specified wheel choice in black

Black rear diffuser

COMFORT PACK (Elise CR only)

CD/MP3/WMA receiver with 4 speakers

Comfort mats with CR logo

Central door locking

Sound insulation

Lightweight aluminium passenger footrest

Front mud flaps

Standard capacity battery

Standard suspension with standard anti-roll bar

TECHNICAL SPECIFICATION

ENGINE

ELISE & ELISE CR All alloy, 1.6 litre DOHC 4 cylinder, dual VVT-i and Valvematic, 16-valve

ELISE S All alloy, 1.8 litre DOHC 4 cylinder, dual VVT-i, 16-valve with Magnuson R900 supercharger utilising Eaton TVS™ technology

Mid mounted, transverse, rear wheel drive

Multi-point sequential fuel injection and direct ignition system

Lotus Electronic Throttle Control system

TRANSMISSION

6 speed manual with sports ratios

Constant mesh helical gears and open differentials

BOSCH Electronic Differential Lock (EDL)

CHASSIS / BODY

Two-door, two seater convertible bodystyle

Lightweight, extruded aluminium bonded structure

Composite front energy absorbing crash structure

Door side impact beams

Composite body panels

Aerodynamically optimised rear diffuser

LED front daylight lamps with integrated direction indicators

LED rear lamps with integrated direction indicators

Black soft top (Optional on Elise CR)

Front mud-flaps (Optional on Elise CR)

Clear sill stone chip protection film

SUSPENSION

Fully independent double wishbone suspension with front anti-roll bar

Bilstein high performance gas dampers, front and rear

Eibach coaxial coil springs, front and rear

STEERING

Solidly mounted, mechanical rack and pinion

BRAKES

AP Racing twin-piston front calipers, Brembo single-piston sliding rear calipers

Servo assisted, cross drilled and ventilated discs, 288 mm diameter, front and rear

Track tuned ABS system

Hydraulic Brake Assist (HBA)

Electronic Brake Distribution (EBD)

Cornering Brake Control (CBC)

Lotus Dynamic Performance Management (Lotus DPM)

WHEELS & TYRES

Lightweight cast alloy wheels, 16" front and 17" rear

Front Yokohama Advan Neova AD07 LTS tyres 175/55 ZR16

Rear Yokohama Advan Neova AD07 LTS tyres 225/45 ZR17

INTERIOR SPECIFICATION

Lightweight aluminum footwell divider

Lightweight aluminum passenger footrest (optional on Elise CR)

Black plain/perforated leather steering wheel (N/A to Elise CR)

Polished aluminum gear knob and handbrake sleeve

Black carpet mats (Optional on Elise CR)

Cloth seats with composite structure (N/A to Elise CR)

Pre-tensioning seatbelts

Engine start push button

Central door locking (Optional on Elise CR)

Radio and CD/MP3 player, integrated iPod® connectivity, with 4 speakers (optional on Elise CR)

Immobiliser and remote activated alarm

Driver and passenger airbags

Electric windows

Face-level air vents

Tyre puncture repair kit

OPTION PACKS (see page 39 for full description)

Touring Pack

Sport Pack

Black Style Pack

Comfort Pack

ADDITIONAL OPTIONS

	ELISE	ELISE CR	ELISE S
Metallic paint	0	N/A	0
Premium paint	0	N/A	0
Motorsport paint	0	N/A	0
Matt paint	N/A	0	N/A
Black soft top	S	0	S
Hard top	0	0	0
Air conditioning	0	0	0

WHEEL OPTIONS

	ELISE	ELISE CR	ELISE S
Standard wheel, silver, lightweight cast, 12-spoke	S	N/A	N/A
Standard wheel, black, lightweight cast, 12-spoke (Black Style Pack required)	0	S	N/A
Standard S wheel, silver, Y-type, lightweight cast, 6-spoke	N/A	N/A	S
Standard S wheel, black, Y-type, lightweight cast, 6-spoke (Black Style Pack required)	N/A	N/A	0
Optional wheel, silver, forged alloy, 14-spoke (Sports Pack required)	0	N/A	0
Optional wheel, black, forged alloy, 14-spoke (Sports Pack and Black Style Pack required on Elise and Elise S)	0	0	0

PERFORMANCE (Manual)

	ELISE	ELISE CR	ELISE S
Max power	134 hp at 6800 rpm (136 PS)(100 kW)	134 hp at 6800 rpm (136 PS)(100 kW)	217 hp at 6800 rpm (220 PS)(162 kW)
Max torque	118 lbft at 4400 rpm (160 Nm)	118 lbft at 4400 rpm (160 Nm)	184 lbft at 4600 rpm (250 Nm)
0-60 mph (seconds)	6.0	6.0	4.2
0-100 km/h (seconds)	6.5	6.5	4.6
Max speed (mph (km/h))	127 (204)	127 (204)	145 (234)
Power to weight ratio			
Hp per tonne	153	157*	235
PS per 1000 kg	155	160*	238

DIMENSIONS / AERODYNAMICS

	ELISE	ELISE CR	ELISE S
Length	3824 mm	3824 mm	3824 mm
Width including mirrors	1719 mm	1719 mm	1719 mm
Height	1117 mm	1117 mm	1117 mm
Wheelbase	2300 mm	2300 mm	2300 mm
Unladen vehicle mass	876 kg	852 kg*	924 kg
Fuel tank capacity	40 litres	40 litres	40 litres
Coefficient	0.41	0.41	0.41

S = Standard 0 = Optional N/A = Not Applicable

*Stated weight includes all weight reductions

LOTUS LIFE

FUEL CONSUMPTION (MPG (L/100KM))

ELISE RANGE

Urban	27.3 (10.3) - 34.0 (8.3)
Extra Urban	47.6 (5.9) - 56.0 (5.0)
Combined	37.5 (7.5) - 45.0 (6.3)
CO ₂ emissions (g/km)	175 - 149



LOTUS DRIVING ACADEMY

Explore the capabilities of the Elise at the famous Lotus Driving Academy. Developed for Lotus drivers of today and tomorrow, you can hone your skills behind the wheel under the guidance of professional instructors, maximising your driving enjoyment in a controlled, fun environment.

www.lotusdrivingacademy.com



LOTUS ORIGINALS

Excellence in development, dedicated craftsmanship and love of detail are all true hallmarks of the Lotus brand and we are now transferring them to the development of our exciting new lifestyle range.

Welcome to Lotus Originals, a collection perfectly reflecting the best of British understatement, authenticity, racing heritage, excellence on design, quality, engineering as well as innovation. Presenting our exciting new lifestyle collection with apparel, clothing accessories, leather items, luxury desk accessories and business gift ideas. Browse our latest collection and find exactly what you're looking for at www.lotusoriginals.com



FURTHER INFORMATION

The information and images in this brochure are based on the current technical data when going to print. As part of a policy of continuous specification improvements, Lotus reserves the right to modify specifications, technical equipment, options and colours at any time. For the latest details please contact your authorised Lotus dealership or visit lotuscars.com.

Throughout this publication, wherever a feature is described as an option it should be assumed that it will be at extra cost to the base vehicle unless specifically stated to the contrary. All model and colour combinations are subject to availability. Certain options or combinations of options may be unavailable in certain markets.

Performance results may vary depending upon the specification of the particular vehicle, environmental conditions, driving style and other factors. Published figures should be used for COMPARISON PURPOSES ONLY AND VERIFICATION SHOULD NOT BE ATTEMPTED ON PUBLIC ROADS. Lotus recommends that all local speed and safety laws must be obeyed and safety belts worn at all times. The track driving and stunt images, for example page 20, contained in this brochure were taken on a closed circuit using professional drivers. Do not attempt to recreate this style of driving. USE OF THE VEHICLE ON TRACK OR IN A COMPETITIVE MANNER IS NOT ENDORSED BY LOTUS. PARTICIPATION IN USE OFF ROAD, INCLUDING ON CLOSED

CIRCUIT TRACKS OR FOR USE IN A COMPETITIVE MANNER, INCLUDING TIMED LAPS OR RUNS WILL INVALIDATE THE MANUFACTURER'S WARRANTY AND THE VEHICLE WILL REQUIRE APPROPRIATE LEVELS OF EXPERT VEHICLE PREPARATION AND SERVICING.

Customers are responsible for ensuring that their cars comply with all relevant road, track and or race regulations at all times. CARS INTENDED FOR TRACK USE ONLY CARRY NO MANUFACTURER'S WARRANTY OTHER THAN THAT REQUIRED BY LAW.

Distributors and dealerships are not agents of Lotus and have absolutely no authority to bind Lotus by any express or implied undertaking or representation. All vehicles should be purchased through an authorised Lotus dealership, please see the dealer locator at lotuscars.com. PURCHASER'S STATUTORY RIGHTS ARE NOT AFFECTED.

Note that current print and photographic techniques do not allow us to faithfully reproduce the full depth and tone of the colours in this brochure. This brochure is designed to provide general product information and is not a contractual document or offer of sale. For current information please contact your authorised Lotus dealership. The details in this brochure cannot be reproduced without the express authorisation of Lotus. © Group Lotus plc 2012.



For further information on the Lotus range,
to find your nearest dealer, or to arrange
a test drive, please visit our website.

LOTUSCARS.COM