

MINIBUSES FORD **TRANSIT**



Go Further



Visionary. Ingenious. Remarkable.
Every vehicle bears his signature.

Henry Ford

No problem

When it comes to moving passengers quickly, safely and in comfort, there's no better choice than the new Ford Transit Minibus.



Model shown is a 15-seat Ford Transit Minibus L3 H2 Trend in Tectonic Silver metallic body colour with 16" alloy wheels (option).

Putting people first

Bigger, roomier and more versatile than ever, Transit Minibus offers a choice of body lengths and seating configurations to carry up to 17 passengers and the driver.



Anywhere you like

Offering comfort, flexibility and space, the new Ford Transit Minibus makes even long journeys a pleasure.



Model shown is a 15-seat Ford Transit Minibus L3 H2 Trend in Deep Impact Blue metallic body colour with 16" alloy wheels (option).

Reclining seats

For added passenger comfort, reclining seat backs and armrests are standard on Trend series. (not applicable to back row quad seats; not available on Base)



Opening rear side windows

Tinted glass is fitted as standard, along with an opening window in the side load door. A further opening window provides additional ventilation for fourth-row passengers.



It all adds up

Spacious and dependable with low ownership costs, and wrapped in an eye-catching body, the new Ford Transit Minibus makes perfect business sense.



Model shown is a 15-seat Ford Transit Minibus L3 H3 Trend in Moondust Silver metallic paint with 16" alloy wheels (option).

Cost of ownership

Transit's impressive 2-year/30,000 mile main service intervals mean less downtime and a significant reduction in operating costs.



Easy

A light and spacious interior with car-like levels of comfort and advanced technology including Ford SYNC with Emergency Assistance*. Ford Transit Minibus successfully combines business with pleasure.



Model shown is a 17-seat Ford Transit Minibus L4 H3 Trend in Lunar Sky metallic body colour.

*Ford Emergency Assistance operates in over 30 European countries. This feature works when paired with a compatible mobile phone that is switched on and with you when an airbag is deployed (excludes knee airbags, if equipped) or the fuel pump shut off switch is activated. In the UK calls are directed through telephone number 112 to 999 services. See ford.co.uk for full details. **Compatible mobile phone required. Text function not supported by all European languages. See your local Ford website for latest information.

Note The Bluetooth® word mark and logos are owned by the Bluetooth SIG, Inc. and any use of such marks by Ford Motor Company Limited and its associated companies is under licence. Other trademarks and trade names are those of their respective owners.

Ford SYNC with Emergency Assistance*

The next generation of in-vehicle connectivity system. Ford SYNC lets you operate most popular MP3 players, Bluetooth®-enabled phones and USB drives with remarkably simple voice commands. It can even read your incoming text messages out for you**. Plus the Ford Emergency Assistance feature is designed to assist the occupants to place a call with the emergency services.



Tow with confidence

We condensed an equivalent 150,000 miles of extreme driving into a six-month test over different road conditions, most of which was spent towing a fully-laden trailer. The new Transit passed with full marks.

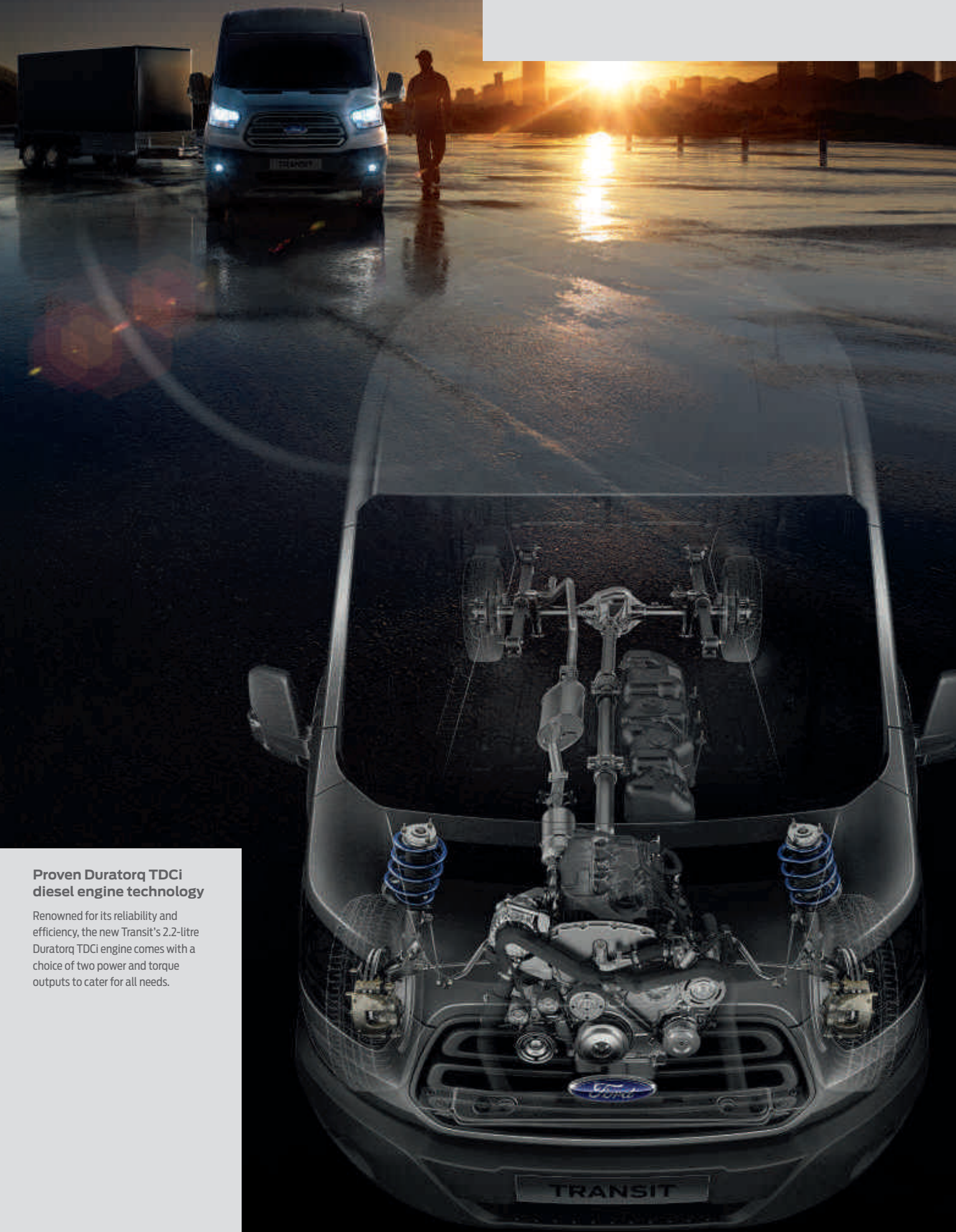

Proven Duratorq TDCi diesel engine technology

Renowned for its reliability and efficiency, the new Transit's 2.2-litre Duratorq TDCi engine comes with a choice of two power and torque outputs to cater for all needs.

Built for a long, tough life

Like every Ford commercial vehicle before it, the new Transit has durability in its DNA. A relentless testing programme ensures that it's a minibus built to last.



High-mounted headlights
Powerful projector-style headlights are located safely out of harm's way. (Standard)

Multi-piece rear bumper
Smart multi-piece rear bumper assembly helps to keep repair costs low.

Tested for endurance
Extensive testing included a two-month maximum speed test and demanding low-speed city drive cycles to imitate typical unforgiving delivery schedules.

Wide bodyside mouldings
Tough bodyside mouldings help to protect your vehicle from accidental damage.



Pushed to extremes
From frost-covered prototypes started up in -40°C at 4,500-metre altitudes, to sun-baked vehicles towing fully-laden trailers up long inclines in 50°C heat, new Transit has been pushed to extremes.



250,000 door shuts
We slammed the sliding door 250,000 times, the front doors 250,000 times and the rear doors 150,000 times to ensure they'll never let you down.



Obsessively driven
During its development, we test drove the new Transit the equivalent of 3 million miles, including 150,000 miles with real customers. It's a vehicle you can rely on, right down to the smallest ball bearing.

12-year perforation warranty
The new Transit owes its durable exterior to a thorough multi-stage painting process. From the wax-injected steel body sections to the hard-wearing top coat, new materials and application processes ensure it will retain its good looks for many years to come.

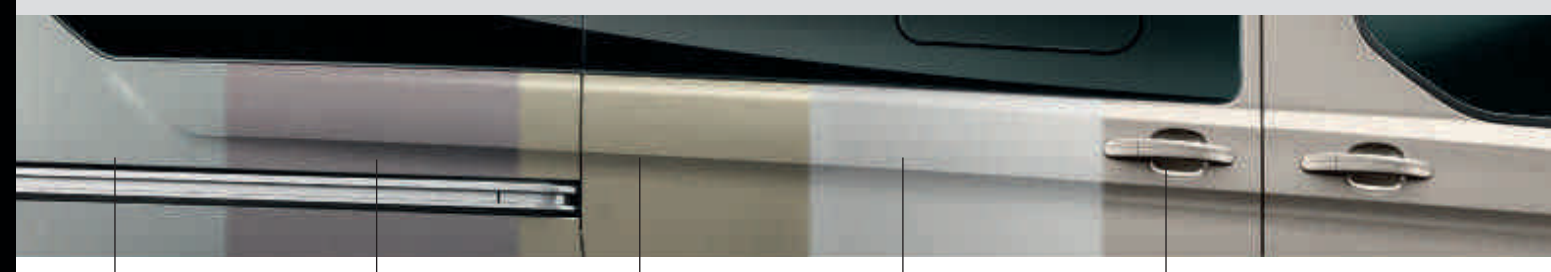

Zinc coating Phosphate coat Electrocoat Top coat Clearcoat

A new dimension in comfort

Ford Transit sets new standards in comfort and control. Easy to drive, with exceptional levels of finish and refinement, smart driver-oriented technology, plus a range of practical and thoughtful features make it a great place to be.



Adjustable driver's seat and steering wheel

An adjustable driver's seat with armrest, and a steering wheel that adjusts to suit your height and arm length mean you can find your ideal driving position with ease. (Standard)

230-volt power socket

A handy 150 Watt 230V power socket, located between the driver's and front passenger's seats, can be used to charge laptops or other electrical equipment without the need for special adaptors. (Option)



First-class comfort in every seat

Reclining seat backs and armrests*, plus the ability to remove rear seats to accommodate wheelchairs or provide extra luggage space, means Ford Transit Minibus opens up a range of new possibilities. Inertia-reel seat belts are fitted to every seat, along with padded head restraints for comfort and security.



*Standard on Trend, option on Base.

Model shown is a 17-seat Ford Transit Minibus L4 H3 Trend.

Electrically-operated driver's seat

A 10-way electrically-adjustable heated driver's seat with lumbar support is an ideal choice for vehicles with multiple drivers. (Option on Trend)



Rear air conditioning

A separate air conditioning system is available for the rear passenger compartment with its own rotary controls. Two foot-level outlets are also provided for each row of seats. (Standard on Trend, option on Base)



Passenger lighting

Individual downlighting adds to the exceptional travelling experience.



Model Shown is a 15-seat Ford Transit Minibus L3 H2 Trend in Moondust Silver metallic paint with 16" alloy wheels (option)

Carries more, consumes less

New Transit's engines are among the most efficient available. Combining reduced fuel consumption with lower CO₂ emissions, you'll enjoy fewer traffic restrictions today and enhanced residual values tomorrow.



Ford ECONetic Technology

Ford ECONetic Technology combined with optimised aerodynamics has resulted in outstanding fuel economy across the range.

- Ford Duratorq TDCi advanced diesel engines – provide exceptional fuel economy and low CO₂ emissions
- Ford Auto-Start-Stop (see below)
- Ford Smart Regenerative Charging
- Economy – Gearshift Indicator light
- Ford Eco Mode – encourages economical driving behaviour
- Acceleration Control (see below)
- Ford Battery Management System – improves battery life, fuel consumption and ensures ready-to-go reliability

The availability of Ford ECONetic Technology varies by model. Please ask your Ford Transit Specialist Dealer for details.

Impressive CO₂ emissions

The latest Duratorq TDCi diesel engines are remarkably fuel efficient, with combined fuel consumption from as low as 38.2 mpg and CO₂ emissions from only 196 g/km. (See fuel consumption and emissions figures on page 28)

Power and torque

Transit's 2.2 Duratorq TDCi diesel engine is available in two power and torque configurations, each driving the rear wheels through a 6-speed manual transmission. Both engines comply with strict HDT Euro 6 emission standards.

- 125 PS (92 kW)/350 Nm
- 155 PS (114 kW)/385 Nm

For more information on our sustainability initiatives visit ford.com/go/sustainability.

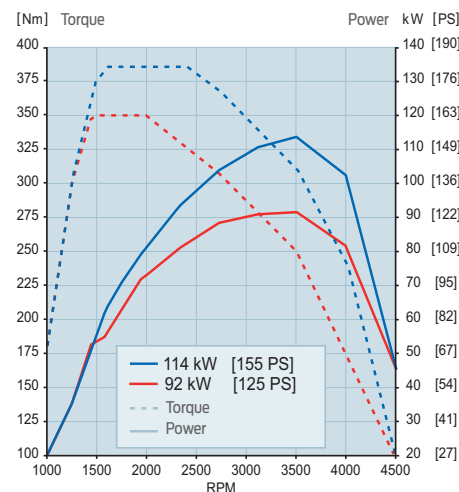

Acceleration Control

To improve fuel economy, Acceleration Control stops the driver from accelerating faster when the vehicle is empty than when it is carrying passengers. (Option)



Auto-Start-Stop

When your vehicle is idling at a standstill, the engine automatically shuts down to save fuel. When you want to drive off, the engine immediately restarts. (Standard)

30,000 miles
or 2 year service intervals

Extended service intervals

Generous main service intervals of up to 30,000 miles (or two years) help keep you on the road longer and further reduce your running costs.

CO₂ 196 g/km
38.2 mpg

CO₂ emissions

Transit ECONetic Technologies deliver low CO₂ emissions from just 196 g/km to provide tax, fuel and environmental benefits. (See fuel consumption and emissions figures on page 28)

Curve Control⁽¹⁾

Designed to help you maintain control of your vehicle when taking a curve too quickly. The system can apply four-wheel smart braking to reduce the vehicle's speed by up to 10 mph in approximately one second. (Standard)

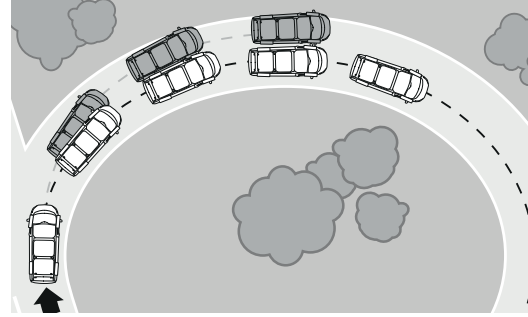

Big on space, big on safety

Safety is important to us, so the new Transit Minibus is built Ford tough to help protect you, your passengers and those around you.

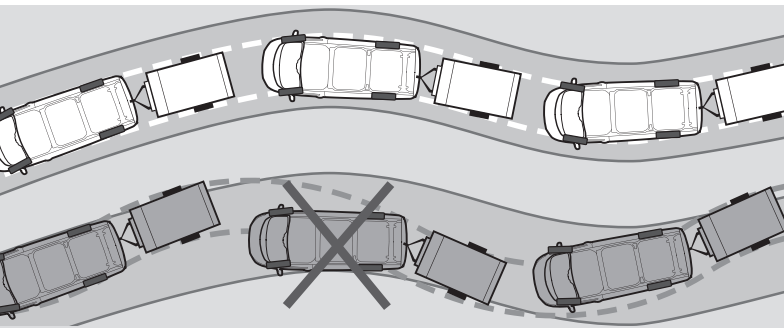

Electronic Stability Control (ESC) and Trailer Sway Control⁽¹⁾

ESC is designed to help you maintain control in extreme driving conditions. It senses when you are deviating from your chosen line and aims to keep you on track by automatically regulating braking and engine output. When Trailer Sway Control⁽¹⁾ recognises that a towed trailer is starting to sway, it reduces engine torque and applies the brakes to lower the speed and help maintain stability. (compatible with Ford factory-fit tow bar)

Traction Control⁽¹⁾

If wheel slip is detected at low speed, the system can distribute more torque to the wheel with most traction. (Standard)

Hill Start Assist⁽²⁾

Designed to temporarily prevent you from rolling down a slope when you move your foot from the brake pedal to the accelerator pedal. It works in forward and reverse gears, so is ideal for towing and pulling heavy loads. (Standard)

Roll-Over Mitigation⁽¹⁾

Designed to identify a potentially dangerous driving situation and activate the ESC⁽¹⁾ to help maintain stability. (Standard)

Load Adaptive Control⁽¹⁾

Designed to adjust the responses of the ESC⁽¹⁾ system to compensate when the vehicle is unladen, partially- or fully-laden. (Standard)

Emergency Brake Assist⁽¹⁾

Designed to recognise an emergency braking situation and optimise the pressure within the braking system to provide maximum stopping power. (Standard)

Emergency Brake Warning⁽²⁾

Front and rear indicators automatically flash during heavy braking, giving other drivers advance hazard warning. (Standard)



Safe and easy access

To comply with the latest safety regulations, Transit Minibus has two or three rows of single/double seats, separated by a straight aisle (depending on wheelbase). A new, extra-wide side load door provides two regulation-size exits. For easier access, all models feature an electrically-operated side step, and passenger assist handles conveniently located on both sides of the side load door.



Lane Keeping Alert^(1)*2)

It only takes a momentary slip in concentration to drift out of your lane when driving on the highway. Lane Keeping Alert⁽²⁾ is designed to recognise when you approach the road markings without using the indicator, and alerts you with vibrations through the steering wheel. (Option)

Automatic headlights⁽²⁾

Designed to switch on the headlights when the sensor detects poor light conditions. (Standard on Trend)



Side curtain airbags⁽¹⁾

In addition to a standard front passenger's airbag the side curtain airbags are designed to help protect the driver's and front passenger's heads from injury. (Option)

⁽¹⁾Uses sensors.

⁽²⁾Operates at speeds over 40 mph on multi-lane roads with clearly visible lane markings.

⁽¹⁾Safety feature.

⁽²⁾Driver assistance feature.

Complete connectivity

Ford SYNC lets you play music and make and receive hands-free calls – all with simple voice commands. And the Ford Emergency Assistance* feature is designed to assist occupants to place an emergency call and provide the emergency services with vehicle location information in their own language. (Standard on Trend, option on Base)

Intelligent features that make life easier

The new Transit Minibus raises the bar for vehicles in this class, with its outstanding range of innovative and thoughtful features.

Adaptive Cruise Control (ACC)

Sophisticated cruise control system that helps to maintain a preset cruising speed and distance from the vehicle ahead. When the system senses a vehicle ahead, it decelerates automatically to keep the desired distance and accelerates back to the preset cruising speed once the road is clear. (Option on Trend)

*Ford Emergency Assistance operates in over 30 European countries. This feature works when paired with a compatible mobile phone that is switched on and with you when an airbag is deployed (excludes knee airbags, if equipped) or the fuel pump shut off switch is activated. AppLink, Emergency Assistance and text function are not supported by all European languages. Compatible mobile phone required. For latest information and a full list of AppLink-compatible apps please visit your regional Ford website.

Note The Bluetooth® word mark and logos are owned by the Bluetooth SIG, Inc. and any use of such marks by Ford Motor Company Limited and its associated companies is under licence. Other trademarks and trade names are those of their respective owners.



Ford Easy-Fuel capless refuelling system

A unique safeguard ensures nobody can accidentally fill up with the wrong fuel. Plus no dirty fuel caps to touch. (Standard. Optional non Easy-Fuel cap available)

Audible SMS

Have your incoming text messages read to you from your connected phone, including commonly-used abbreviations and emoticons, and you can even respond with a choice of 15 preset text messages. Compatible mobile phone required.



Bluetooth® Audio Streaming

Stream your music collection from your compatible MP3 player or mobile phone to the vehicle's audio system.



Rear-view camera

Select reverse and the image from the rear-view camera is displayed automatically in the rear-view mirror. Marker lines overlaid on the camera image indicate where the vehicle is heading. (Option)



Parking distance sensors, front and rear

An audible warning helps you judge the distance between your vehicle and obstacles at the front and rear, for easier parking and manoeuvring. (Standard on Trend, option on Base)



Projector style halogen headlights with static cornering lights

When you turn the steering wheel beyond 30 degrees, cornering lights illuminate the appropriate side of the road for extra visibility at night. (Standard on Trend, option on Base)

SYNC AppLink

Control your favourite mobile apps from your supported smartphone using voice commands and buttons on the steering wheel. (Available from Summer 2014)



Emergency Assistance*

Designed to assist occupants in contacting emergency services on your paired Bluetooth®-enabled phone when an airbag is deployed.

More seats mean more business

Powerful engines with enough torque to satisfy the most demanding business uses, space to carry up to seventeen passengers, plus the driver. Together they make the Transit Minibus the vehicle of choice for a range of passenger-carrying businesses.

People power

With the best possible choice of seating configurations, wheelbase lengths and powertrain options, new Transit Minibus has what it takes to get the job done.

Minibus Medium Wheelbase (L2)
Medium Roof (H2)

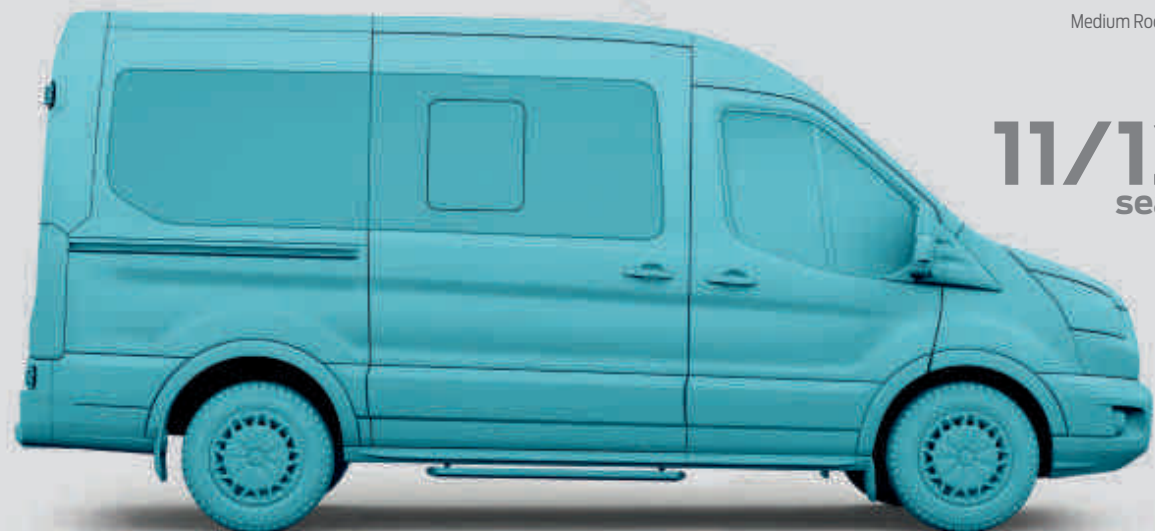

11/12
seats

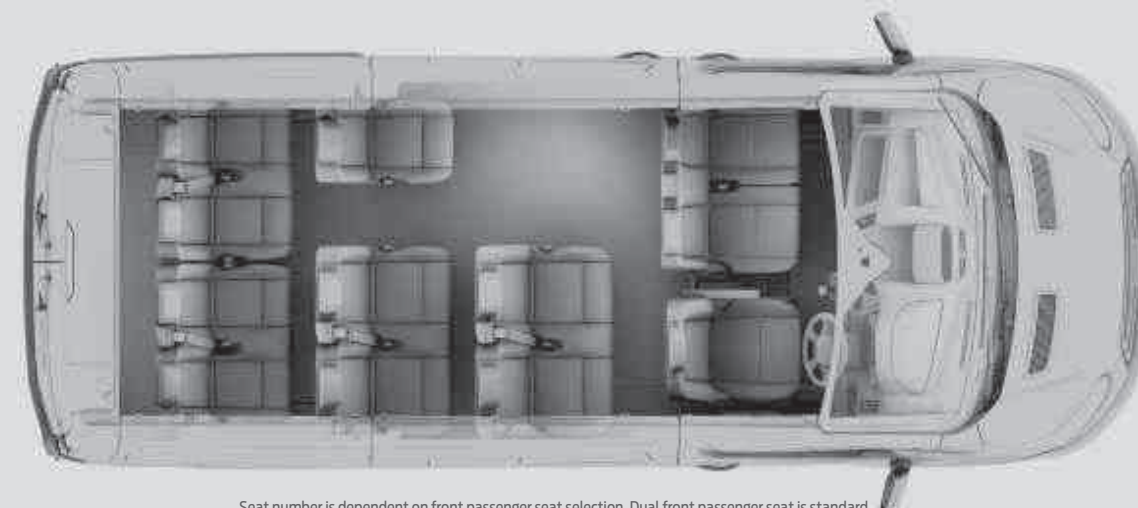

Seat number is dependent on front passenger seat selection. Dual front passenger seat is standard offering 12-seat configuration, single front passenger seat option offers 11-seat configuration.

Minibus Long Wheelbase (L3)
Medium Roof (H2)
High Roof (H3)



14/15
seats

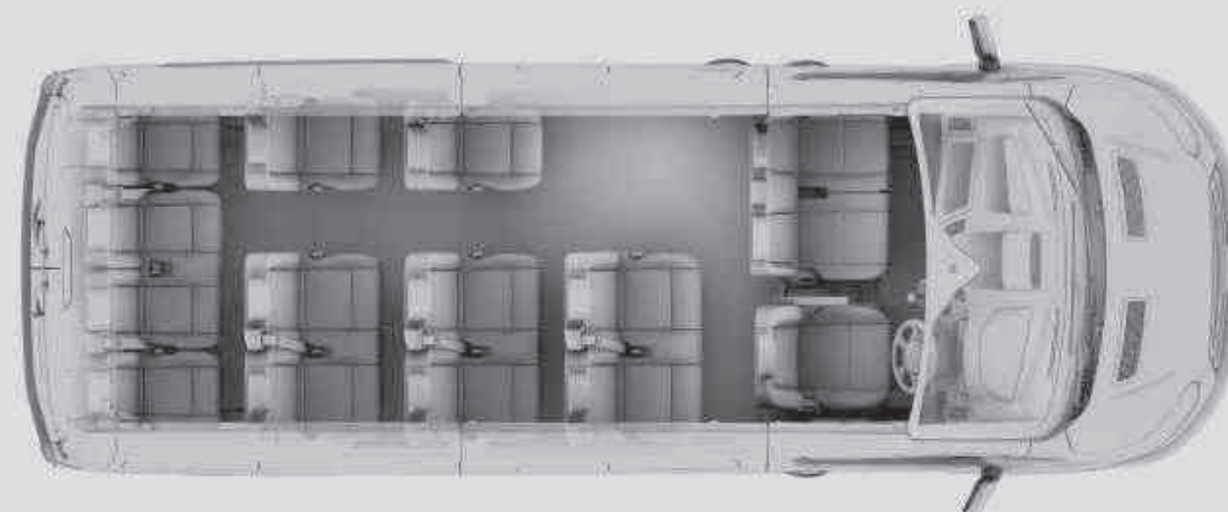

Seat number is dependent on front passenger seat selection. Dual front passenger seat is standard offering 15-seat configuration, single front passenger seat option offers 14-seat configuration.

Minibus Extended Frame 'Jumbo' (L4)
High Roof (H3)



17/18
seats

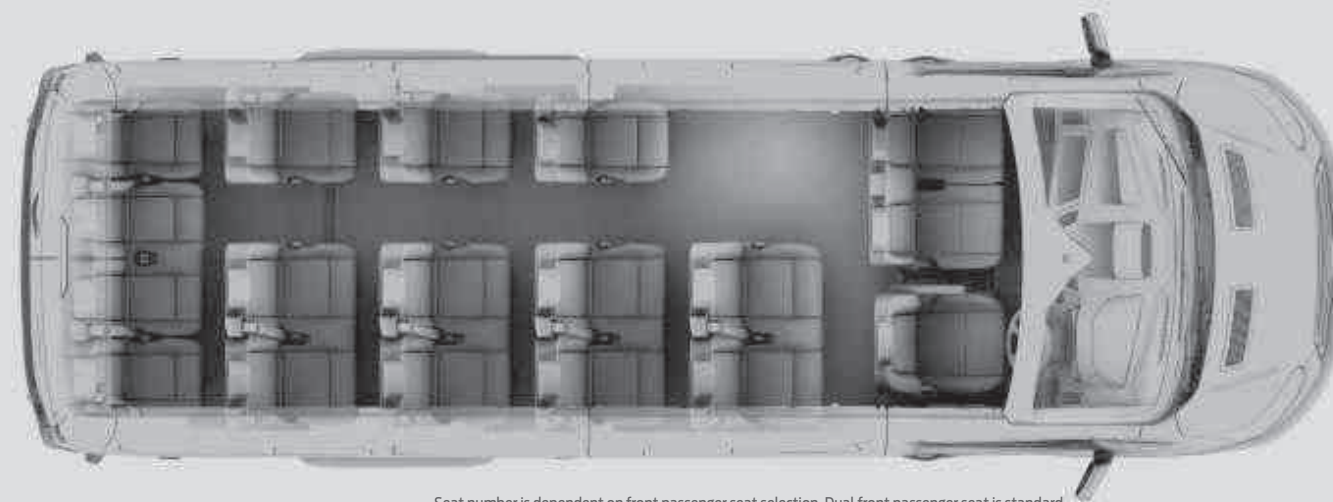

Seat number is dependent on front passenger seat selection. Dual front passenger seat is standard offering 18-seat configuration, single front passenger seat option offers 17-seat configuration.

The Range



Base

Exterior features

- Day running lights
- Remote central locking
- Wide bodyside mouldings
- Power side step
- Integrated rear step
- Auto Start-Stop System
- ESC/ABS/Hill Start Assist
- Curve Control
- Emergency Brake Warning
- Full size spare wheel
- Ford Easy-Fuel capless refuelling
- Euro VI emissions compliant

Option Pack

- Low Visibility Pack



Trend

Exterior features over Base specification

- Front fog lights
- Power heated folding mirrors
- Automatic headlights
- Rain-sensing wipers
- Heated windscreen
- Power heated folding mirrors
- Projector style headlights with static cornering lights
- Front and rear parking sensors
- Twin remote keys
- Full wheel covers (with single rear wheels only)
- Metallic Paint

Option Pack

- Premium Visibility Pack



Base

Interior features

- Radio with AUX, Bluetooth, USB/iPod connectivity and remote controls
- Rake and reach steering adjustment
- Trip computer
- Power windows 1 shot up/down
- 8-way adjustable driver's seat with armrest
- Dual Passenger with under-seat storage
- Fold out front passenger seat table
- Glovebox with A4 file storage
- 2 x 12V power points
- Overhead stowage console



Trend

Interior features over Base specification

- Front & rear air conditioning
- Cruise Control with Adjustable speed limiter
- Radio/CD with Ford SYNC and Emergency Assistance
- Leather-trimmed 4-spoke steering wheel
- Leather-trimmed gearshift knob
- Driver seat lumbar adjust
- Lockable glovebox
- Privacy glass from B-pillar rearwards
- Reclinable rear seats with armrests

Note The Bluetooth® word mark and logos are owned by the Bluetooth SIG, Inc. and any use of such marks by Ford Motor Company Limited and its associated companies is under licence. Other trademarks and trade names are those of their respective owners.

Dimensions

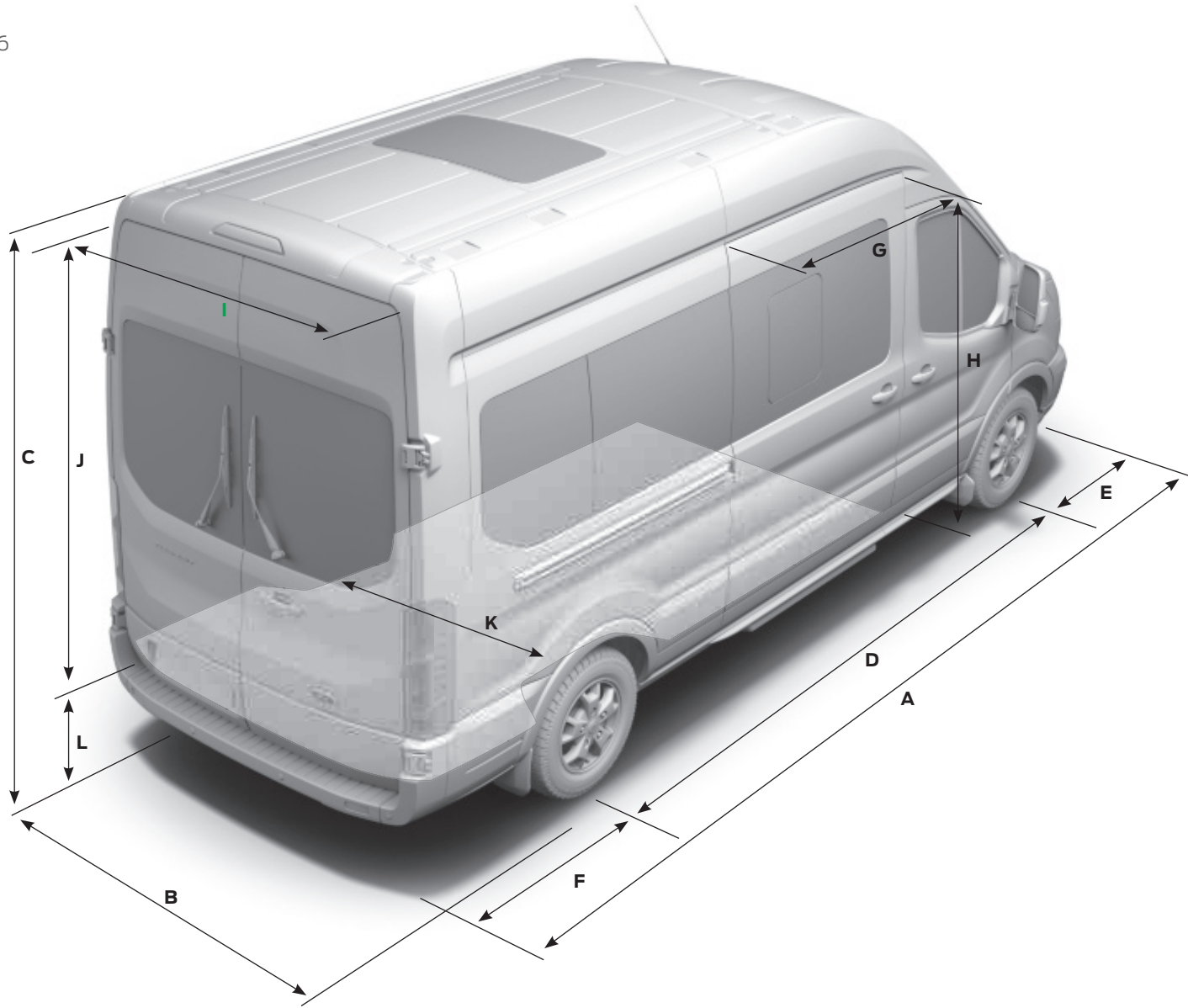

L2, H2

11/12-seats

L3, H2

14/15-seats



L3, H3

14/15-seats

L4, H3

17/18-seats



Dimensions

	11/12-Seat L2 H2 RWD	14/15-Seat L3 H2 RWD	14/15-Seat L3 H3 (High Roof) RWD	17/18-Seat L4 H3 RWD
A Overall length	5531	5981	5981	6704
B Overall width (with/without mirrors)	2474/2059	2474/2059	2474/2059	2474/2126
C Overall height*	2490-2550	2481-2547	2720-2786	2746-2781
D Wheelbase	3300	3750	3750	3750
E Front of vehicle to front wheel centre	1023	1023	1023	1023
F Rear of vehicle to rear wheel centre	1208	1208	1208	1931
G Side door entry width	1300	1300	1300	1300
H Side door entry height	1600	1600	1600	1600
I Rear door entry width	1565	1565	1565	1565
J Rear door entry height	1648	1648	1887	1887
K Space between wheel arches	1392	1392	1392	1154
L Loading height*	511-668	522-684	522-684	606-675
Turning circle (m)				
Kerb to kerb 16" wheels	11.9	13.3	13.3	13.3
Wall to wall 16" wheels	12.6	13.9	13.9	13.9

L2 = Medium wheelbase, **L3** = Long wheelbase, **L4** = Long wheelbase extended length. **H2** = Medium Roof, **H3** = High Roof. **RWD** = Rear-Wheel Drive. All dimensions (shown in mm) are subject to manufacturing tolerances and refer to minimum specification models and do not include additional equipment. These illustrations are for guidance only. *Height dimensions show the range from minimum to maximum of a fully laden, lowest payload vehicle to unladen highest payload vehicle.

Model availability

	11/12-Seat 350 L2 H2	370 L2 H2	14/15-Seat 410 L3 H2	410 L3 H3 (High Roof)	17/18-Seat 460 L4 H3
RWD					
2.2 Duratorq TDCi 125 PS (92 kW) HDT Euro 6	●	●	●	●	●
2.2 Duratorq TDCi 155 PS (114 kW) HDT Euro 6	●	●	●	●	●

● = Available. **L2** = Medium wheelbase, **L3** = Long wheelbase, **L4** = Long wheelbase extended length. **H2** = Medium Roof, **H3** = High Roof. **RWD** = Rear-Wheel Drive, **HDT** = Heavy Duty Test.

28 Weights, loads and fuel

	Gross payload ⁸	Gross vehicle mass (kg)	Kerb mass (kg)*	Front axle plated mass (kg)	Front axle kerb mass (kg)	Rear axle plated mass (kg)	Rear axle kerb mass (kg)	Axle ratio	Max. GTM (kg)	Max trailer weight braked (unbraked)	CO ₂ emissions (g/km) ^{9,10}	Fuel consumption in mpg (L/100 km) ¹⁰		
												Urban	Extra Urban	Combined
11/12-Seat 350 L2 H2														
2.2 Duratorq TDCi (HDT Stage VI)	938	3500	2562	1750	1299	2100	1263	3.31	3500	n/a	196	31.4 (9.0)	43.5 (6.5)	38.2 (7.4)
11/12-Seat 370 L2 H2														
2.2 Duratorq TDCi (HDT Stage VI)	1145	3750	2605	1750	1321	2250	1284	3.31	5500	2650 (750)	196	31.4 (9.0)	43.5 (6.5)	38.2 (7.4)
14/15-Seat 410 L3 H2														
2.2 Duratorq TDCi (HDT Stage VI)	1334	4100	2766	1850	1386	2500	1380	3.31	5500	2500 (750)	196	31.4 (9.0)	43.5 (6.5)	38.2 (7.4)
14/15-Seat 410 L3 H3														
2.2 Duratorq TDCi (HDT Stage VI)	1307	4100	2793	1850	1392	2500	1400	3.31	5500	2500 (750)	196	31.4 (9.0)	43.5 (6.5)	38.2 (7.4)
17/18-Seat 460 L4 H3														
2.2 Duratorq TDCi (HDT Stage VI)	1589	4600	3011	1850	1353	3050	1658	3.31	5350	2100 (750)	196	31.4 (9.0)	43.5 (6.5)	38.2 (7.4)

L2 = Medium wheelbase, **L3** = Long wheelbase, **L4** = Long wheelbase extended length. **RWD** = Rear-Wheel Drive. All models are 6-speed manual transmission. **GVM** – Gross vehicle mass. The total permissible all-up weight of a rigid vehicle – i.e. with body, payload, ancillaries, fuel, oil, water, driver and crew. ***Kerb mass** – The weight of the complete vehicle and all equipment including fuel and water, but without the payload, driver or any crew. **GTM** – Gross train mass. The total permissible all-up weight of a rigid vehicle (see GVM) together with its trailer and load. **Gross payload** = Gross vehicle mass, less kerb mass. All kerb masses quoted in this brochure are subject to manufacturing tolerances and are for models with minimum equipment. Trend models will have greater kerb masses and, therefore, lower payloads due to the increased amount of standard equipment. Any additional options specified on the vehicle will reduce the payload accordingly. ¹⁰The declared fuel consumption and CO₂ emissions for Stage VI engines are measured according to the technical requirements and specifications of European Regulation (EC) 715/2007 and latest amendment. Fuel consumption and CO₂ emissions are specified for a vehicle type and not for a single vehicle. Stage VI engines require urea additive. The applied standard test procedure enables a comparison between different vehicle types; the specification and options selected may have an effect i.e. on vehicle weight and therefore on the emissions and fuel economy of the vehicle and also may influence the figures that appear in the individual vehicle documentation. This information is not part of any product offer made. Real world fuel consumption can vary as the fuel efficiency of a vehicle is influenced by (individual) vehicle configurations, driving behaviour, use of technical equipment such as air conditioning, as well as other non-technical factors.

Mechanical features

	Base	Trend
Engine Technology		
Auto-Start-Stop system	●	●
Ford Eco Mode (driver information system)	●	●
Acceleration Control	○	○
cDPF (coated diesel particulate filter)	●	●
Brakes		
Dual-circuit, with self-adjusting servo-assistance and ABS. Front and rear discs	●	●
Fuel tank		
80 litres	●	●
Ford Easy-Fuel capless refuelling system with misfuel inhibit	●	●
Ford Easy-Fuel capless refuelling system without misfuel inhibit	○	○
Steering		
Power-assisted steering	●	●
Steering column – Rake- and reach-adjustable	●	●
Suspension		
Front, independent MacPherson struts, coil springs, stabiliser bar and gas-pressurised shock absorbers. Rear, leaf springs and gas-pressurised shock absorbers	●	●
Engine governors		
Speed Limiter – 62 mph	●	●

● = Standard, ○ = Option, at extra cost.



Luggage space

Transit Minibus offers generous passenger accommodation and, thanks to the removable rear seat centre section, it has easily-accessible luggage space too. For added versatility, the inner pair of seats from the penultimate row can also be removed.



Even better ride and handling

Ford Transit's renowned driving qualities have been fine-tuned with stiffer suspension mounting bushes and brackets, and a newly-designed anti-roll bar.

30 Safety and security

	Base	Trend
Safety and driver assistance		
Anti-lock brakes – Electronic, 4-wheel ¹⁾	●	●
Electronic Stability Control ¹⁾	●	●
Curve Control ¹⁾	●	●
Hill Start Assist (HSA) ²⁾	●	●
Load Adaptive Control (LAC) ¹⁾	●	●
Emergency Brake Assist (EBA) ¹⁾	●	●
Emergency Brake Warning (automatic activation of hazard warning lights under heavy braking) ²⁾	●	●
Roll-Over Mitigation (ROM) ¹⁾	●	●
Trailer Sway Control (TSC) compatible with Ford tow attachments ¹⁾	○	○
Airbag – Driver's ¹⁾	●	●
Airbag – Front passenger's with deactivation switch ¹⁾	●	●
Airbag – Front side airbags ¹⁾	○	○
Airbag – Front side curtain airbags ¹⁾	○	○
Seat belts – 3-point diagonal inertia reel (all seats) ¹⁾	●	●
Tyre Pressure Monitoring ¹⁾	○	○
Emergency Release Hammer	●	●
First Aid Kit	○	○
Fire Extinguisher 2L	●	●
Security		
Alarm – Perimeter	○	○
Immobiliser – Safeguard Passive Anti-Theft System (PATS) (Insurance-approved Category 2 immobiliser)	●	●
Locks – Power central locking	●	●
Locks – Remote control central locking with one key fob	●	–
Locks – Remote control central locking with two key fobs	○	●
Locks – Additional manual fleet key	○	–
Locks – Auto relocking, doors relock after 45 seconds if no door is opened	●	●
Locks – Key-operated bonnet release	●	●
Vehicle Identification Number – Visible	●	●

● = Standard, ○ = Option, at extra cost.

***Note: A rear-facing child seat should never be placed in the front passenger seat when the Ford vehicle is equipped with an operational front passenger's airbag.**

¹⁾Safety feature, ²⁾Driver assistance feature.

Exterior

	Base	Trend
Design features		
Roof Height – H2 (Medium Roof; not available on 17/18-seat)	●	●
Roof Height – H3 (High Roof; standard on 17/18-seat, not available on 11/12-seat)	○/●	○/●
Door mirrors – Blind spot eliminator and integrated side indicator	●	●
Door mirrors – Manual	●	–
Door mirrors – Power-foldable, electrically-operated and heated	○	●
Bodyside mouldings – Wide	●	●
Front bumper – Partial body colour	●	●
Rear bumper – Self colour with integrated step	●	●
Front grille – Grey	●	–
Front grille – Titanium effect	–	●
Mudflaps – Front	○	○
Mudflaps – Rear	●	●
Glass – Tinted complete (71% luminous transmittance)	●	○
Glass – Rear privacy (33% luminous transmittance)	○	●
Tow bar with Trailer Sway Control with 13-pin electrics (tachograph may be required)	○	○
Paint – Metallic	○	○+
Wheels		
Wheels – 6½x16" steel wheels (Fitted with 235/65 R16 tyres; L2 and L3 only)	●	●
Wheels – 6½x16" steel wheels, dual rear wheels, wheel covers on front wheels (Fitted with 195/75 R16 tyres; L4 only)	●	●
Wheels – 6½x16" alloy wheels with locking wheel nuts (Fitted with 235/65 R16C tyres)	–	○
Wheel covers – Half caps (excludes dual rear wheels)	●	–
Wheel covers – Full (excludes dual rear wheels)	–	●
Spare – Full-size steel with tool kit	●	●

● = Standard, ○ = Option, at extra cost, ○+ = No Charge Option, □ = Part of an option pack, at extra cost.

L2 = MWB 11/12-seat, **L3** = LWB 14/15-seat, **L4** = ELWB 17/18-seat.

Tyre Pressure Monitoring

Allows you to monitor tyre pressure while on the move. System alerts you if it detects that a tyre's pressure is too low, such as in the case of a puncture. (Option)



Exterior

	Base	Trend
Convenience features		
Headlights – Projector style halogen reflector lights with chrome background and blue highlight, cornering lights	○	●
Headlights – Day running lights	●	●
Headlights – Headlight courtesy delay	●	●
Heated windscreen	□	●
Front fog lights	○	●
Doors – Passenger's sliding glazed side load door and power step	●	●
Doors – Glazed hinged rear doors, 180° opening with wash/wipe	●	●
Doors – Glazed hinged rear doors, 270° opening, with magnetic door retainers (not available on L2, optional on L3 and standard on L4)	○	○
Roof escape hatch	●	●
Windows – Second row, fixed	○	–
Windows – Second row, opening	●	●
Windows – Third row, fixed	●	●
Windows – Fourth row, fixed (Standard on L3; not available on L2 and L4)	●	●
Windows – Fourth row, sliding (Standard on L4; not available on L2 and L3)	●	●
Wipers – Front, variable interval/intermittent with electrically-operated wash	●	●
Wipers – Rear with auto reverse wipe and electrically-operated wash (Not available on L4)	●	●
Parking distance sensors – Front and rear (requires front fog lights)	○	●
Option packs		
Visibility Pack (Low) – Heated windscreen, washer fluid sensor, electrically-operated and heated door mirrors	○	–
Visibility Pack (High) – Heated windscreen, washer fluid sensor, electrically-operated and heated, power-foldable door mirrors, auto headlights, rain-sensing wipers, front fog lights, and variable cluster dimming	–	●
Visibility Pack (Premium) – Rear-view camera, Lane Keeping Alert, High and High series instrument cluster	–	○
Lane Keeping Alert (includes high series instrument cluster, leather-trimmed steering wheel, autowipers and heated windscreen)	○	○

● = Standard, ○ = Option, at extra cost, ○+ = No Charge Option, □ = Part of an option pack, at extra cost.
L2 = MWB 11/12-seat, **L3** = LWB 14/15-seat, **L4** = ELWB 17/18-seat.

Steering wheel-mounted controls

Allow you to operate the audio system and trip computer without taking your hands off the wheel.



Quickclear heated windscreen

Clears ice or demists the windscreen quickly, even on frosty mornings. Supplied with heated washer jets for year-round comfort and visibility. (Standard on Trend, option as part of a pack on Base)

Interior

	Base	Trend
Design features		
Floor covering – Complete, easy-clean and rubber insulated	●	●
Headlining – Complete (covers full length of vehicle)	●	●
Steering wheel – 4-spoke polyurethane	●	–
Steering wheel – 4-spoke, leather-trimmed	□	●
Gearshift knob – Leather-trimmed	–	●
Interior lighting		
Courtesy lights – Front and rear lights and map-reading lights with theatre-style dimming	●	●
Courtesy lights – Footwell illumination (side load door only)	●	●
Interior lighting/battery saver – 30 minutes	●	●
Loadspace compartment lights	●	●
Audio and communication systems		
Audio – Pre-equipment pack	○	○
Radio with Bluetooth® Includes AUX connection for external music devices, Hands-Free Phone and Voice Control System with USB/iPod® connectivity port and iPod® functionality, remote audio controls, two front speakers, two rear speakers ICE Pack 2	●	–
Radio with DAB and Bluetooth® Includes AUX connection for external music devices, Hands-Free Phone and Voice Control System with USB/iPod® connectivity port and iPod® functionality, remote audio controls, two front speakers, two rear speakers ICE Pack 3	○	–
Radio/CD with Ford SYNC Includes 3.5" dot matrix display, extended integrated control panel, Ford SYNC – includes Emergency Assistance*, Bluetooth® and Voice Control and audible text messaging, USB and Privacy Mode, AUX connection for external music devices, USB connectivity port with iPod® functionality, remote audio controls, four front speakers (two woofers and two tweeters), two rear speakers ICE Pack 4	○	●
Radio/CD with DAB and Ford SYNC Includes 3.5" dot matrix display, extended integrated control panel, Ford SYNC – includes Emergency Assistance*, Bluetooth® and Voice Control and audible text messaging, USB and Privacy Mode, AUX connection for external music devices, USB connectivity port with iPod® functionality, remote audio controls, four front speakers (two woofers and two tweeters), two rear speakers ICE Pack 5	○	○
Radio/CD with Navigation, DAB and Ford SYNC Includes 5" TFT screen, extended integrated control panel, Ford SYNC – includes Emergency Assistance®, Bluetooth® and Voice Control and audible text messaging, USB and Privacy Mode, AUX connection for external music devices, USB connectivity port with iPod® functionality, remote audio controls, four front speakers (two woofers and two tweeters), two rear speakers. (Available from summer 2014) ICE Pack 11	○	○

● = Standard, ○ = Option, at extra cost, □ = Part of an option pack, at extra cost.
L2 = MWB 11/12-seat, **L3** = LWB 14/15-seat, **L4** = ELWB 17/18-seat.

Lidded storage compartment with power point and USB port

Cleverly concealed storage compartment, located above the instrument cluster, features a 12-volt power supply, AUX input and USB port.



Note: The Bluetooth® word mark and logos are owned by the Bluetooth SIG, Inc. and any use of such marks by Ford Motor Company Limited and its associated companies is under licence. Other trademarks and trade names are those of their respective owners.

*Ford Emergency Assistance operates in over 30 European countries. This feature works when paired with a compatible connected mobile phone that is switched on and with you when an airbag is deployed (excludes knee airbags, if equipped) or the fuel pump shut off switch is activated. Text function not supported by all European languages. Compatible mobile phone required. See your local Ford website for latest information.

	Base	Trend
Instruments and controls		
Trip computer (distance to empty, instant and average fuel consumption, average speed, outside temperature)	●	●
Water in fuel filter with sensor	●	●
Battery – Twin improved flooded (IF) 80Ah, 700 CCA	●	●
Alternator – Standard duty (150 Amp)	●	●
Alternator – Heavy duty (220 Amp) (requires front air conditioning)	○	–
Tachograph – Digital, electronic, 24-hour	○	○
Cruise control (includes leather-trimmed steering wheel and Adjustable Speed Limiter)	○	●
Adaptive Cruise Control with Forward Alert (includes high series instrument cluster and front and rear parking sensors)	–	○
Shift Indicator light	●	●
Seats		
Driver's seat – 8-way (fore/aft; recline; height; and tilt) with armrest (and lumbar, at Trend)	●	●
Driver's seat – 10-way power, heated (fore/aft; recline; height; tilt; and lumbar) with armrest	–	○
Front passenger's seat – Single, 8-way heated (fore/aft; height, tilt, and recline)	○	○
Front passenger's seat – Dual, fixed back with lift-up seat cushion for stowage, fold out table	●	●
Front passenger's seat – Dual, heated, fixed back with lift-up seat cushion for stowage, fold out table	○	○
Rear seats – Second row, fixed dual bench seat	●	●
Rear seats – Third row, dual bench seat, single seat	●	●
Rear seats – Fourth row, dual bench seat, single seat (L3 only)	●	●
Rear seats – Fourth row, quad bench seat (standard on L2, optional L3)	●	●
Rear seats – Fifth row, dual bench seat and single seat (L4 only)	●	●
Rear seats – Fifth row, quad bench seat, removable (L3 only)	●	●
Rear seats – Sixth row, quad bench seat, removable (L4 only)	●	●
Rear seat recline with fixed armrests (not available on last row seating)	–	●

● = Standard, ○ = Option, at extra cost, □ = Part of an option pack, at extra cost.
L2 = MWB 11/12-seat, **L3** = LWB 14/15-seat, **L4** = ELWB 17/18-seat.

Note: The Bluetooth® word mark and logos are owned by the Bluetooth SIG, Inc. and any use of such marks by Ford Motor Company Limited and its associated companies is under licence. Other



Larger windscreen

New Transit's windscreen is significantly larger than the previous model. Extra front glass area, plus taller front door windows mean greater visibility and a lighter, airier cab.

	Base	Trend
Comfort and convenience		
Air conditioning – Front, filter-air pollen purifier	○	–
Air conditioning – Front and Rear (includes filter-air pollen purifier)	○	●
Heater – PTC (positive thermal coefficient, provides additional heat during warmup)	●	●
Assist handle – Located on passenger A-Pillar	●	●
Assist handle – Located on B-Pillar	●	●
Bottle holder – Twin, 2-litre bottle capacity, fascia-mounted	●	●
Glovebox – With lid and A4 file storage capability	●	–
Glovebox – With lockable lid	–	●
Power point socket – 2 x 12V (located on instrument panel and in stowage bin)	●	●
Power point socket – 12V (located in rear)	○	○
Power point – 150 Watt (230 volt) power converter	○	○
Rear-view camera in rear-view mirror (includes Trailer Hitch Assist)	○	○
Smokers' Pack – Cigar lighter and ash cups	○	○
Storage – Front door map pockets	●	●
Storage – Driver's side, storage compartment on fascia top with lift-up lid	●	●
Windows – Front, electrically-operated (driver's side – one shot up/down)	●	●

● = Standard, ○ = Option, at extra cost, □ = Part of an option pack, at extra cost.
L2 = MWB 11/12-seat, **L3** = LWB 14/15-seat, **L4** = ELWB 17/18-seat.



Bottle holders

Bottle holders are located on either side of the instrument panel, with cup holders above. In addition, the front door pockets are designed to accommodate a 2-litre drink bottle. (Standard)

Features

36 Special vehicle options

	SVO Code	Base	Trend
Body			
Spare wheel access with rear doors closed	A532	<input type="radio"/>	<input type="radio"/>
Electrical			
Engine RPM Speed Control, 1300-3000rpm	A003	<input type="radio"/>	<input type="radio"/>
2 High Performance Deep Cycle AGM Batteries (2 x 95 Ah capacity, 850 CCA batteries under driver's seat)	A736	<input type="radio"/>	<input type="radio"/>
Auxiliary fuse panel	A526	<input type="radio"/>	<input type="radio"/>
Beacon Preparation Pack – switch and wiring front and rear (includes Auxiliary fuse panel A526)	A606	<input type="radio"/>	<input type="radio"/>
Paint			
Special Paint, 130 solid colours available, consult Dealer for details*	Various	<input type="radio"/>	<input type="radio"/>

○ = Option, at extra cost.
SVO paint suffix must be entered at time of ordering. SVO paint pulls self-colour (black) bumpers, bodyside mouldings, mirror housings and door handles.

Colour and trim

Choose the body colour that you think best reflects your business brand.



Frozen White
Solid body colour



Race Red
Solid body colour



Blazer Blue
Solid body colour



Tectonic Silver
Metallic body colour*



Stratosphere
Metallic body colour*



Deep Impact Blue
Metallic body colour*



Midnight Sky
Metallic body colour*



Moondust Silver
Metallic body colour*



Lunar Sky
Metallic body colour*



Panther Black
Metallic body colour*

Headlights and front fog lights

Trend series is equipped with projector-style signature headlights, featuring a chrome background and cornering light. Front fog lights further enhance Transit's lighting performance. (Standard on Trend)

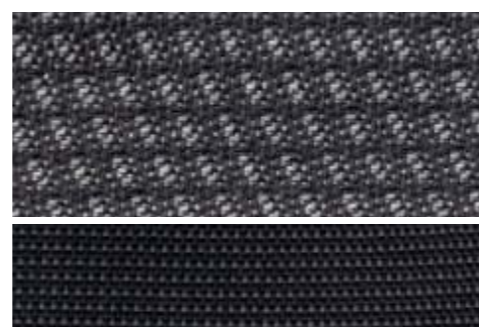

Base

Traxon seat insert in Charcoal Black
Max seat bolsters in Charcoal Black

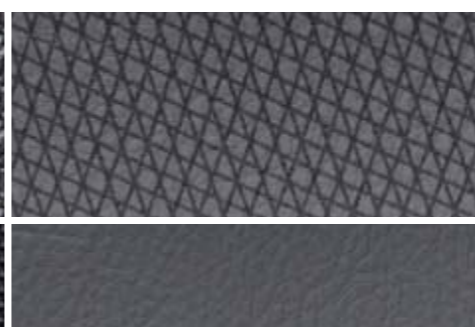

Base

Arctec Vinyl seat insert in Pewter**
Prima Vinyl seat bolsters in Pewter**



Trend

Lane seat insert in Charcoal Black
Max seat bolsters in Charcoal Black

Special Vehicle Options (SVO)

While the Ford Commercial Vehicle range already offers an extensive choice of off-the-shelf features and options, the Special Vehicle Options (SVO) programme goes a step further. Practical options range from high performance batteries to a choice of 130 colours to match your company's livery. For more information, please speak to your local Ford Transit Specialist Dealer.

*Metallic body colours are options at extra cost.

**Option for Base only.

The Ford Transit is covered by the Ford Corrosion Protection Warranty for 12 years from the date of first registration. Subject to terms and conditions.

Note The vehicle images used are to illustrate body colours only and may not reflect current specification. Colours and trims reproduced within this brochure may vary from the actual colours, due to the limitations of the printing processes used.

Making life easy

Our range of finance, service and assistance options is designed with just one thing in mind – making life easy for you.

Commercial Vehicle Finance

At Ford, we can help you find the right vehicle to suit your needs, whether its for business or pleasure. Our wide range of competitive finance products can help you get on the road – quickly and easily.

Ford Credit: Provides a range of traditional finance products for customers who are interested in Commercial Vehicle ownership.

Ford Lease: Specialises in contract hire and leasing and provides an alternative range of finance products aimed at business customers (business users only).

Both are part of one of the world's biggest names in automotive finance, and can offer you affordable, flexible and innovative products.

Important Information:

Ford Credit: Finance subject to status. Guarantees may be required. Freepost Ford Credit.

Ford Lease: Ford Lease is provided by ALD Automotive Ltd, trading as Ford Lease, Oakwood Park, Lodge Causeway, Fishponds, Bristol, BS16 3JA. ALD Automotive is registered in England No. 987418. For the purposes of the Data Protection Act 1998 the data controllers in relation to any information you supply are Ford Motor Company Limited, FCE Bank Plc and ALD Automotive. Finance subject to status. Guarantees and indemnities may be required. ALD Automotive is authorised and regulated by the Financial Conduct Authority in respect of general insurance products. Ford Lease is a registered trademark of Ford Motor Company Limited.

Services

There are 164 Sales and 219 Aftersales Ford Transit Specialist Dealers across the UK, equipped and trained to meet Commercial Vehicle customer requirements. From these, 101 Sales and 92 Aftersales Dealers have achieved the 'premium standard' as recognition of their total commitment to delivering dedicated and professional sales and service support.

To find the location of your nearest Ford Transit Specialist Dealer, simply call the Ford Information Service on 0845 7111 888, or visit the Ford Dealer locator at www.fordvans.co.uk

Ford Protect Every new Ford Fiesta Van is protected by a 3-year/60,000-mile Ford Protect Classic Warranty Plan, and also comes with a 1-year Ford Assistance package.

Ford Ranger is protected by a 3-year/60,000 mile Ford Protect Classic Warranty Plan.

Ford Transit, Transit/Tourneo Custom and Transit/Tourneo Connects are protected by a 3-year/100,000-mile bumper-to-bumper warranty.

Ford Transit Chassis Cab One-Stop bodywork is covered by a 3-year/100,000-mile warranty and a 3-year Perforation Warranty provided by the bodywork supplier.

Ford Perforation Warranty Ford Ranger, Transit, Transit/Tourneo Custom, Transit/Tourneo Connect and Fiesta Van are covered by the Ford Perforation Warranty for 12 years from the date of first registration. Subject to terms and conditions. Please see your Ford Transit Specialist Dealers for details.

Ford Assistance Ford Transit, Transit Custom, Transit Connect and Rangers are supplied with a minimum of a 1-year Ford Assistance roadside package. Further details are available either on www.ford.co.uk or from your local Ford Dealer.

Ford Rapid Fit Our 'no appointments necessary, while-you-wait' fast-fit service for exhausts, brakes, batteries and more, at over 240 sites nationally.

Ford Accident Repair Centres Approved Ford Accident Repair Centres meet rigorous Ford standards and are the best place to return your vehicle to its pre-accident condition.

Contacts

Ford Customer Relationship Centre In the unlikely event that your Ford Dealer can't help you or if you need to speak to us directly, call 0845 841 1111 at local rates.

Ford Rental – local service nationwide Car and van rental from our latest model range. Contact your local Ford Dealer for more information.

Talkback – the company car drivers' club This is your club for extended test drives, special events, and advice on tax and buying issues. Join free, even if you don't drive a Ford, on www.talkbackclub.com or call 0845 605 55 66.

Ford Mobility Our MAGIC care centre provides free information on all motoring and mobility issues, including special offers for HRDLA and Motability recipients. Call free on 0800 240 241.

*Subject to terms and conditions.



MY 2014 GBR en

Illustrations, descriptions and specifications. This catalogue was correct at the time of going to print. However, Ford policy is one of continuous product development. The right is reserved to change specifications, colours and prices of the models and items illustrated and described in this publication at any time. For the latest details always consult your Ford Dealer. **Optional equipment.** Throughout this publication, wherever a feature is described as being an 'Option' or 'Option Fitment/Pack' etc, you should assume that it will be at extra cost to the base vehicle, unless specifically stated to the contrary. All models and colour combinations are subject to availability. **Note.** Some images portrayed are of a pre-production model and/or are computer generated, therefore, the design/features on the final version of the vehicle may differ in various respects. In addition, some of the features shown on the vehicles may be optional. **Note.** This brochure contains both original Ford accessories as well as a range of products from our suppliers. **+**The identified accessories are carefully selected third party supplier branded accessories which do not come with a Ford warranty but are instead covered by the third party supplier's own warranty, the details of which can be obtained from your Ford Dealer. **Note.** The Bluetooth® word mark and logos are owned by the Bluetooth SIG, Inc. and any use of such marks by Ford Motor Company is under licence. The iPod word mark and logos are the property of Apple Inc. Other trademarks and trade names are those of their respective owners. **Note.** Some driver assistance features and safety features described in this brochure are designed to function using sensors, whose performance may be affected under certain weather or environmental conditions.

The Government fuel figures do not express or imply any guarantee of the fuel consumption of any particular vehicle. The vehicles themselves have not been tested and there are inevitably differences between individual vehicles of the same model. In addition, a vehicle may incorporate particular modifications. Furthermore, the driver's style and road and traffic conditions, as well as the extent to which the vehicle has been driven and the standard of maintenance, will affect its fuel consumption. **Insurance groups** are only as recommended by the Association of British Insurers. You should always consult your insurance adviser for confirmation.



Ford and BP – working together to reduce fuel consumption and emissions.



Collect Nectar points at participating Ford Dealers and Authorised Repairers now. So take a look at the latest Ford Service Promotions by visiting the Owner Services section within www.ford.co.uk.



BY APPOINTMENT TO
HER MAJESTY THE QUEEN
MOTOR VEHICLE MANUFACTURERS
FORD MOTOR COMPANY LIMITED
BRENTWOOD ESSEX



BY APPOINTMENT TO
HIS ROYAL HIGHNESS THE PRINCE OF WALES
MOTOR VEHICLE MANUFACTURERS
FORD MOTOR COMPANY LIMITED
BRENTWOOD ESSEX



When you have finished with this brochure please recycle it.

Ford One Call

In the unlikely event that your Ford Dealer can't help you or if you need to speak to us directly, call 0203 564 4444

Ford Rental - local service nationwide

Car and Van rental from our latest model range. Contact your local Ford Dealer for more information

Ford Motability

Our dedicated care centre provides free information on all motoring and mobility issues, including special offers for HRDLA and Motability recipients. Call free on 0845 6040019

Finance

Ford Credit Customer Services 0845 712 5490
Ford Lease Customer Services 0844 600 1405

Published by Ford Motor Company Limited, Brentwood, Essex, England. Registered in England No. 235446. FA 1576

BJN 201722. FoE H58E. PN 377512/1113/9m/GBR en November 2013.

© Ford Motor Company Limited.

www.ford.co.uk