

FORD TOURNEO CONNECT



Go Further



Visionary. Ingenious. Remarkable.
Every car bears his signature.

Henry Ford





Life should be a balance not a compromise.

The Ford Tourneo Connect is a relaxing and comfortable place to be. Great to drive, great to sit in, it boasts premium finishes, high-quality materials and fuel efficiency without compromising everyday practicality.

Models shown on previous spread:
(Left) Ford Tourneo Connect Titanium with Solar metallic body colour (option) with 17" alloy wheels (option).
(Right) Ford Grand Tourneo Connect Titanium with Burnished Glow metallic body colour (option) with 17" alloy wheels (option).

Built for a long and adventurous life.

Real life is about taking the rough with the smooth. It involves the occasional bump and scrape. It's about opening and closing doors thousands of times, sitting in traffic jams and enjoying the open road.

Tested to extremes for toughness and durability, both in the laboratory and in real-world conditions, the new Ford Tourneo Connect can take it all.



Use your voice like another pair of hands.

Ford SYNC with Emergency Assistance lets you play music, make and receive hands-free calls – with simple voice commands. And the Ford Emergency Assistance* feature is designed to assist occupants to place an emergency call and provide the emergency services with vehicle location information in their own language.

*Compatible mobile phone required. AppLink and Emergency Assistance not supported by all European languages. For latest information and a full list of AppLink-compatible apps please visit www.Ford.co.uk. (AppLink available from Summer 2014)



“Call Dad”

“Shuffle”

“Read message”

“Call office”

“Call Chris”

“Call home”

“Play artist Rolling Stones”

“What’s playing?”





Surround yourself with smart ideas.

At Ford, the smart ideas are the ones that make your life a little easier. In the Tourneo Connect, you'll find front and rear parking sensors, auto headlights and wipers and a rear-view camera in the overhead mirror for easier reversing. There's also a multitude of storage compartments, including underfloor stowage and a hidden compartment in the instrument panel that can store and charge your portable electronic devices.

Flexibility is the mother of convenience.

The seats in the Tourneo and Grand Tourneo Connect take adaptability to a new level. The Tourneo second row seats tumble forward or can be removed. In the Grand Tourneo the second row drops flat for easy access to the third row, which can also be folded flat to create a totally level surface to make room for larger loads. Handy stowage solutions, including overhead lockers for your passengers' belongings, keep the cabin clutter free. From 7 adults to a kayak, and most things in between, if you need to move it, the Tourneo and Grand Tourneo Connect can take it..

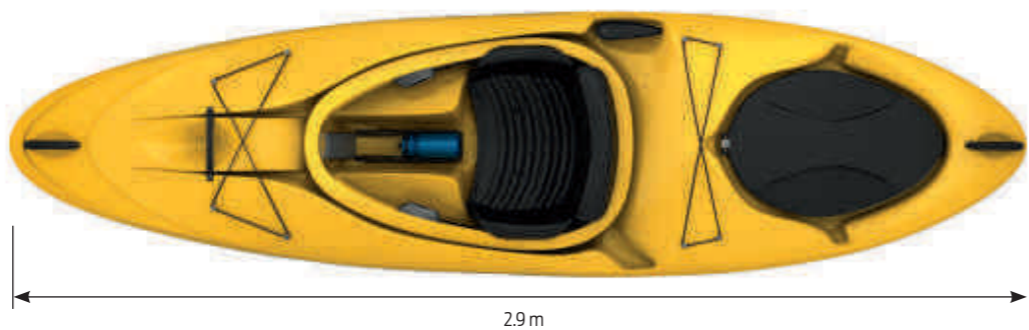

1. Secure high-level stowage space
2. Aircraft style overhead lockers
3. Overhead stowage



Petrol or diesel?

We've made both options equally tempting.

1.0 & 1.6 EcoBoost

With turbocharging, direct petrol injection and variable valve timing, our award-winning EcoBoost engines deliver the same performance as larger engines, but with much better fuel economy and lower emissions.



1.6 Duratorq TDCi

Our new Duratorq TDCi diesels impress with their refined power and superb efficiency. Cruising on the motorway or out on the highways and byways, their smooth torque delivery is invaluable on inclines or when overtaking.

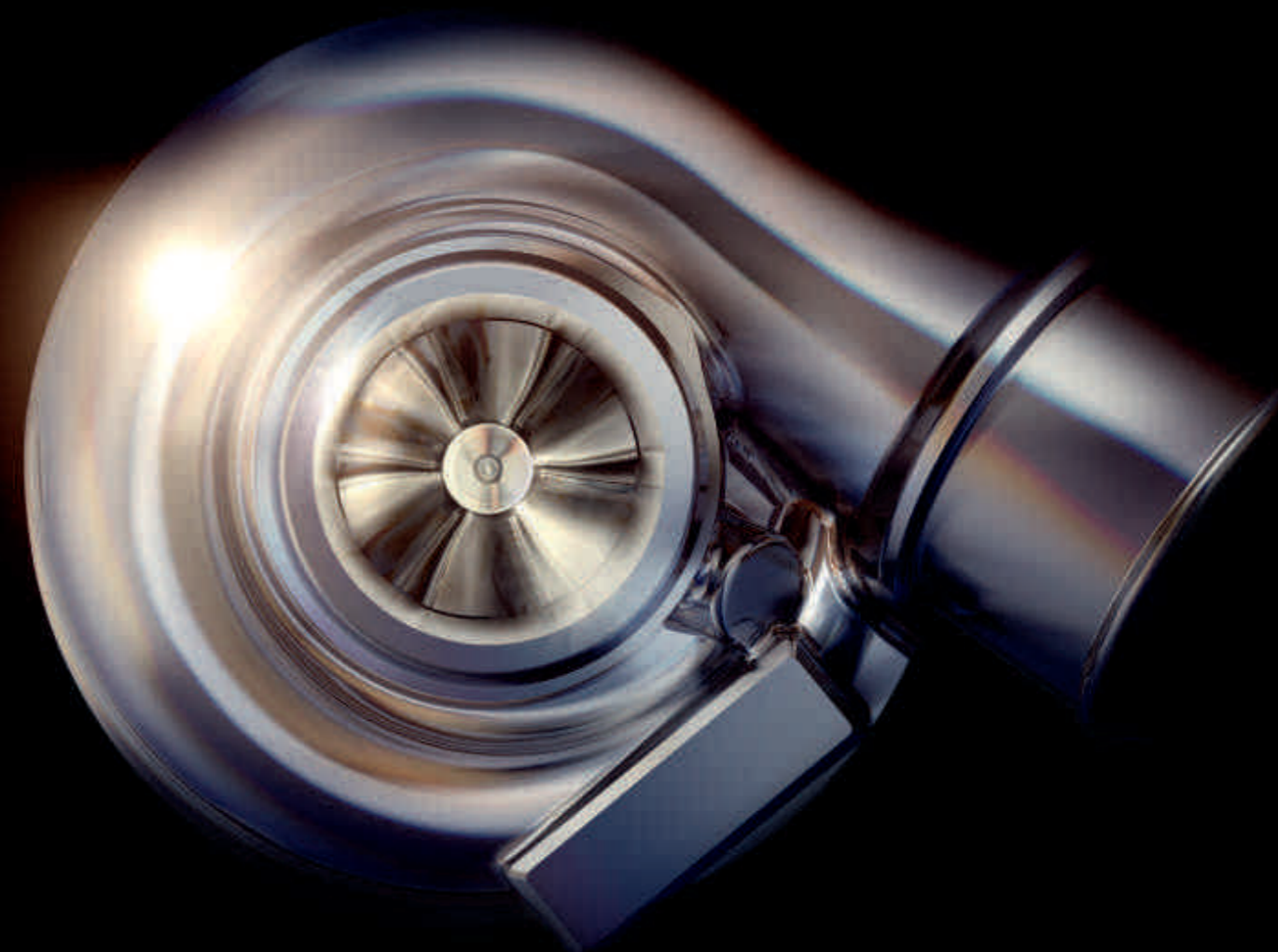



Style

Key exterior features

- 16" steel wheels with full wheel covers
- Body colour front bumper
- Manual door mirrors with blind spot eliminator
- Dual sliding rear doors
- 'Easy fuel' fuel filler
- Day Running Lights
- Rear liftgate with high mounted brake light
- ESC with ABS and EBA
- Immobiliser, remote central/double locking

Option packs available:

City Safety, City, Comfort,

Zetec

Exterior features in addition to Style

- Electrically-operated and heated door mirrors
- Front fog lights
- 'Quickclear' heated windscreen and washer jets

Option packs available:

City Safety, Style

Titanium

Exterior features in addition to Trend

- 16" 5-spoke alloy wheels
- Body colour bodyside mouldings & door handles
- Panorama roof and rear privacy glass
- Body colour rear bumper
- High gloss chrome headlamp bezels and grille splitter
- Integrated roof rails with crossbars
- Power-foldable, body coloured door mirrors
- Active City Stop
- Rear parking distance sensors
- Auto-headlamps & rain-sensing wipers
- Static Cornering lights



Style

Key interior features

- DAB radio with USB, Bluetooth and Voice Control, with Steering wheel controls
- Power front windows, one-shot down on driver's side
- Front overhead shelf & instrument panel stowage box
- 12V power point in front and rear
- Rake & Reach adjustable steering column
- Full front, side and curtain airbags

Zetec

Interior features in addition to Style

- Power second row windows
- DAB radio/CD system with 3.5" dot-matrix multi-function display, MP3 capability, SYNC with Emergency Assistance, Bluetooth® with Voice Control and six speakers
- Manual air conditioning
- Front dome light with two map lights
- Lockable glovebox
- Second row overhead stowage (from Q2 '14)
- 12V power point in luggage compartment

Titanium

Interior features in addition to Zetec

- One-touch up/down power front windows with global opening/closing
- Child observation mirror
- Rear overhead console (5-seat versions, from Q2 '14)
- Front floor mats
- Dual Zone Air Temperature Control
- Cruise Control
- Leather-trimmed steering wheel & gearknob
- Auto-dimming rear-view mirror
- Chrome door handles
- Seat back trays and passenger map pocket

Note The Bluetooth® word mark and logos are owned by the Bluetooth SIG, Inc. and any use of such marks by Ford Motor Company Limited and its associated companies is under licence. Other trademarks and trade names are those of their respective owners.
iPod® is a trademark of Apple Inc.

We chose
Solar.
Which one will
you choose?



Frozen White
Solid body colour



Moondust Silver
Metallic body colour*



Burnished Glow
Metallic body colour*



Panther Black
Metallic body colour*



Blazer Blue
Solid body colour



Tectonic Silver
Metallic body colour*



Deep Impact Blue
Metallic body colour*



Magnetic
Metallic body colour*
(Available from August 2014)



Race Red
Solid body colour



Solar
Metallic body colour*



Midnight Sky
Metallic body colour*
(Available until July 2014)

*Metallic body colours are optional at extra cost.
The Ford Tourneo Connect is covered by the Ford Perforation Warranty for 12 years from the date of first registration. Subject to terms and conditions.
Note The car images used are to illustrate body colours only and may not reflect current specification or product availability in certain markets. Colours and trims reproduced within this brochure may vary from the actual colours, due to the limitations of printing processes used.

A feel for comfort.

Whether you choose Style, Zetec or Titanium, you'll find stylish but practical interior trims.



1. Style

Insert: Traxon in Charcoal Black
Bolster: Max in Charcoal Black

2. Zetec

Insert: Route in Charcoal Black
Bolster: Max in Charcoal Black

3. Zetec

Insert: Route in Medium Stone
Bolster: Max in Medium Stone

3. Titanium

Insert: Chicane in Charcoal Black
Bolster: Malt in Charcoal Black

5. Titanium

Insert: Chicane in Medium Stone
Bolster: Malt in Medium Stone





Wheels



16" 5-spoke alloy wheel
(Option and accessory)



17" 10-spoke alloy wheel
(Option and accessory)

Wheels	Tourneo Connect			Grand Tourneo Connect		
	Style	Zetec	Titanium	Style	Zetec	Titanium
Steel – 16"x 6½, Style wheel covers (Fitted with 205/60 tyres)*	●	-	-	●	-	-
Steel – 16"x 6½, Zetec wheel covers (Fitted with 205/60 tyres)*	-	●	-	-	●	-
Alloy – 16"x6½" 5-spoke (Fitted with 205/60 tyres)*	-	○	●	-	○	●
Alloy – 17"x6½" 10 spoke (Fitted with 215/50 tyres)*	-	-	○	-	-	○
Spare wheel (standard inflator kit)	○	○	○	○	○	○

● = Standard, ○ = Option, at extra cost, □ = Part of an option pack, at extra cost.
*The wheel you choose will be fitted with the tyre size noted, but no choice of tyre brand is available.

Generous service intervals of up to 20,000 miles
(or 1 year) further reduce your running costs.

Exterior features

	Touneo Connect			Grand Touneo Connect		
	Style	Zetec	Titanium	Style	Zetec	Titanium
Design features						
Front bumper – Body colour	●	●	●	●	●	●
Rear bumper – Body colour	-	-	●	-	-	●
Door handles – Self-colour	●	●	-	●	●	-
Door handles – Body colour	-	-	●	-	-	●
Door mirrors – Manual and heated, foldable, self-coloured housings	●	-	-	●	-	-
Door mirrors – Electrically-operated and heated, self-coloured housings	○	●	-	○	●	-
Door mirrors – Electrically-operated and heated, power-foldable, body-coloured housings	-	-	●	-	-	●
Front grilles – Self-colour	●	●	-	●	●	-
Front grilles – Self colour with bright inserts	-	-	●	-	-	●
Active Grille Shutter (part of fuel economy pack: standard on petrol engines, not available on diesel 115 PS engine)	●/□	●/□	●/□	●/□	●/□	●/□
Wide bodyside moulding – Self-colour	●	●	-	●	●	-
Wide bodyside moulding – Body colour	-	-	●	-	-	●
Fog light bezels – Black	●	-	-	●	-	-
Fog light bezels – Body colour	-	●	●	-	●	●
Roof rails	○	-	-	○	-	-
Roof rails including crossbars	○	○	●	○	○	●
Tow bar (13 pin), fixed (includes Trailer Sway Control)	○	○	○	○	○	○
Mudflaps – Front and rear	○	○	○	○	○	○
Front lip spoiler (not fitted on petrol engine vehicles)	●/-	●/-	●/-	●/-	●/-	●/-

5% reduction in aerodynamic drag.

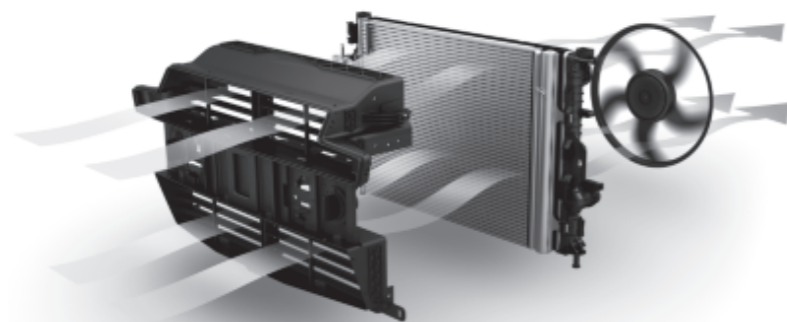

Active Grille Shutter

Designed to improve aerodynamics and lower fuel consumption. (Standard on 1.0-litre EcoBoost, option as part of Fuel Economy Pack)

Exterior features

	Touneo Connect			Grand Touneo Connect		
	Style	Zetec	Titanium	Style	Zetec	Titanium
Convenience features						
Doors – Dual side	●	●	●	●	●	●
Doors – Rear cargo tailgate	●	●	●	●	●	●
Parking distance sensor – Rear	○	○	●	○	○	●
Parking distance sensor – Front	-	○	○	-	○	○
Windscreen – Quickclear Heated	○	●	●	○	●	●
Wipers – 2-speed variable intermittent	●	●	-	●	●	-
Rain sensitive wipers	□	□	●	□	□	●
Window – Rear wash/wipe	●	●	●	●	●	●
Windows – Sliding 2nd row, both sides	○	●	●	○	●	●
Windows – Fixed 3rd row, both sides	●	●	●	●	●	●
Rear window – Fixed, Heated	●	●	●	●	●	●
Rear privacy glass (in addition to standard tinted)	-	○	●	-	○	●
Panorama roof	-	○	●	-	○	●
Fog lights – Front	-	●	-	-	●	-
Fog lights – Front Static Cornering	-	○	●	-	○	●
Fog lights – Rear	●	●	●	●	●	●
Headlights – Halogen, with black bezel (chrome on Titanium)	●	●	●	●	●	●
Headlights – Courtesy delay	□	□	●	□	□	●
Headlights – Day running lights	●	●	●	●	●	●
Headlights – Automatic	□	□	●	□	□	●
High-mounted rear brake light	●	●	●	●	●	●
Option Packs						
City Pack (Active City Stop, reverse parking aid, Quickclear heated windscreen, power heated door mirrors, auto headlights - available from Spring 2014)	○	-	-	○	-	-
Comfort Pack (manual air conditioning, cruise control with Adjustable Speed Limiting Device)	○	-	-	○	-	-
City Safety Pack (Active City Stop, auto headlights, Quickclear heated windscreen)	○	-	-	○	-	-
Style Pack (roof rails, rear privacy glass, 5-spoke 16" alloy wheels)	-	○	-	-	○	-

● = Standard, ○ = Option, at extra cost, □ = Part of an option pack, at extra cost.

*The wheel you choose will be fitted with the tyre size noted, but no choice of tyre brand is available.

Quickclear heated windscreen

Designed to demist the screen in seconds, even on frosty mornings.



Interior guide

Ford Tourneo Connect comes with a wealth of useful features to help make your life a little easier and delivers the most connected and enjoyable driving experience. Amongst the features you'll find are:

1. Leather-trimmed steering wheel with audio and cruise control toggles
2. Leather-trimmed gearshift knob
3. Radio/CD system with 3.5" dot-matrix multi-functional display, MP3 capability, SYNC with Emergency Assistance, Bluetooth® with Voice Control and six speakers
4. Dual-zone Electronic Automatic Temperature Control (DEATC)
5. Trip computer (standard)
6. Dual front cup holders (standard)
7. 12V power point in instrument panel
8. Lockable glovebox with illumination
9. Drivers's Instrument panel storage compartment
10. Driver's sunglasses holder
11. Child observation mirror
12. Heated windscreen
13. Cruise control with Adjustable Speed Limiter
14. Height- and reach-adjustable steering column (standard)
15. 1.5-litre bottle holder in door (standard)
16. Card/ticket holders in lower instrument panel

Audio technology

MP3-compatible with six speakers, remote audio controls, AUX and USB connection for external music devices and Ford SYNC including Ford Emergency Assistance, featuring hands-free Bluetooth® -enabled Voice Control System and audio streaming. (Option)

Shown right: DAB radio/CD with 3.5" TFT colour multi-functional display
Note The Bluetooth® word mark and logos are owned by the Bluetooth SIG, Inc. and any use of such marks by Ford Motor Company Limited and its associated companies is under licence. Other trademarks and trade names are those of their respective owners.



Interior features

	Tourneo Connect			Grand Tourneo Connect		
	Style	Zetec	Titanium	Style	Zetec	Titanium
Design features						
Steering wheel – 4-spoke PU with black shells	●	-	-	●	-	-
Steering wheel – 4-spoke PU with aluminium shells	□	●	-	□	●	-
Steering wheel – 4-spoke leather-trimmed with aluminium shells	□	□	●	□	□	●
Door handle – Black	●	●	-	●	●	-
Door handle – Chrome finish	-	-	●	-	-	●
Gearshift knob – PU	●	●	-	●	●	-
Gearshift knob – Leather-trimmed (standard on petrol automatic)	-	-	●	-	-	●



View and control
playlists without touching
your MP3 player.

Remote audio controls

Your hands on the wheel and your MP3 on the right track.
(Remote audio controls are standard)

The Bluetooth® word mark and logos are owned by the Bluetooth SIG, Inc. and any use of such marks by Ford Motor Company is under licence. Other trademarks and trade names are those of their respective owners.

Ford Emergency Assistance operates in over 30 European countries. This feature works when paired with a compatible connected mobile phone that is with you when an airbag is deployed (excludes knee airbags and rear inflatable safety belts, if equipped) or the fuel pump shut off switch is activated. See your local Ford website for latest information.

Interior features

	Tourneo Connect			Grand Tourneo Connect		
	Style	Zetec	Titanium	Style	Zetec	Titanium
Audio and communication systems						
DAB Radio, AUX connection for external music devices, Bluetooth® Hands-Free Phone and Voice Control System with USB/iPod® connectivity port and iPod® functionality, remote audio controls, two front speakers, two rear speakers. ICE Pack 2	●	-	-	●	-	-
DAB Radio/CD with DAB, 3.5" multi-functional display Includes message centre, 4 speakers front, 2 speakers rear, MP3 capability, Ford SYNC (includes Emergency Assistance, Bluetooth® and Voice Control and audible text messaging, USB and Privacy mode). ICE Pack 6	○	●	●	○	●	●
DAB Radio/CD with DAB, 5" multi-functional display with Navigation, 4 speakers front, 2 speakers rear, MP3 capability and Ford SYNC 1 (includes Emergency Assistance, Bluetooth® and Voice Control and audible text messaging, USB and Privacy mode) includes Traffic Message Centre, and rear-view camera. ICE Pack 9	○	○	○	○	○	○
Climate control						
Pollen filter	●	●	●	●	●	●
Air conditioning – Manual control	○	●	-	○	●	-
Air conditioning – DEATC (Dual zone Electronic Automatic Temperature Control)	-	-	●	-	-	●
PTC heater (front)	●	●	●	●	●	●

● = Standard, ○ = Option, at extra cost, □ = Part of an option pack, at extra cost.

Centre console with stowage bin including power point and AUX MP3 socket

Open centre console with 1 x 12V socket, AUX connectivity, USB connectivity, USB connectivity with charging, 2 cup-holders and storage designed to accommodate an A4 folder (Standard)



Interior features

	Touneo Connect			Grand Touneo Connect		
	Style	Zetec	Titanium	Style	Zetec	Titanium
Comfort and convenience						
Floor mats – Front	○	○	●	○	○	●
Cruise Control with ASLD (automatic speed limiting device)	○	○	●	○	○	●
Trip/fuel computer	●	●	●	●	●	●
Ford Eco mode	-	●	●	-	●	●
Courtesy lights – Header mounted	●	-	-	●	-	-
Courtesy lights – Front dome light with 2 map lights	-	●	●	-	●	●
Courtesy lights – Rear overhead	●	●	●	●	●	●
Interior lighting/battery saver – 30 minutes	●	●	●	●	●	●
Auto-dimming rear-view mirror	□	□	●	□	□	●
Dual front cup holders	●	●	●	●	●	●
Rear-view camera with mirror display. Includes Reverse Parking Sensor	○	○	○	○	○	○
Power point socket – 12V (located in instrument panel)	-	●	●	-	●	●
Power point socket – 12V (located in front and rear of console)	●	●	●	●	●	●
Locking glovebox lid	-	●	●	-	●	●
Glovebox illumination	-	-	●	-	-	●
Instrument panel storage box	-	●	●	-	●	●
Rear seat centre armrest (2nd row)	-	-	●	-	-	●
Full width front overhead shelf	●	●	●	●	●	●
Mid-vehicle overhead stowage (not available with Panorama Roof)	-	●	-	-	●	-
Rear seat overhead console (not available with third row seats)	-	○	●/-	-	○/-	●/-
Centre console	●	●	●	●	●	●
Driver's sunglasses holder	-	-	●	-	-	●
Windows – Electrically-operated front with driver one-touch down	●	●	-	●	●	-
Windows – Electrically-operated front with one-touch up/down and global opening/closing	-	-	●	-	-	●
Windows – Fixed 2nd row rear	●	-	-	●	-	-
Windows – Electrically-operated 2nd row (one-touch on Titanium)	○	●	●	○	●	●
Child observation mirror	-	-	●	-	-	●
Driver and passenger sunvisors (with mirror, and ticket pocket for driver)	●	●	●	●	●	●
Smokers' Pack – Cigarette lighter and ashtray	○	○	○	○	○	○
Interior grab handles (front)	●	●	●	●	●	●

● = Standard, ○ = Option, at extra cost, □ = Part of an option pack, at extra cost.

12V socket in luggage area for coolbox

A handy socket provides an ideal power source for your coolbox. (Option) Waeco coolboxes* are high-performance and cool to a minimum of 1°C and warm up to 65°C. 230V AC connector integrated. Various models available also with ISOFIX. Shown is coolbox BordBar TE-21-ISO. (Accessory)



Innovative stowage solutions

With both underfloor (in second row footwell) and overhead stowage capability and seats that can be removed, Touneo Connect offers great ways to carry luggage items, no matter how large or small.

*Item covered by third party supplier's warranty.



Interior features

	Tourneo Connect			Grand Tourneo Connect		
	Style	Zetec	Titanium	Style	Zetec	Titanium
Seats						
Driver's seat (4-way) (fore/aft + recline)	●	-	-	●	-	-
Driver's seat (8-way) (fore/aft + recline, height, lumbar)	○	●	●	○	●	●
Driver's seat – Rotary seat recline	●	●	●	●	●	●
Seat belt reminder system (driver and passenger)	●	●	●	●	●	●
Front 2-way head restraints (up/down)	●	●	●	●	●	●
Flip/fold/tumble passenger seat (fold flat)	●	●	-	●	●	-
Passenger seat (4-way) (fore/aft + recline)	-	-	●	-	-	●
Passenger lever seat recliner	●	●	●	●	●	●
Driver's seat – Map pocket	-	●	●	-	●	●
Passenger seat map pocket	-	-	●	-	-	●
Driver and Passenger Heated Seats (with Dark interior trim only)	-	○	○	-	○	○
Rear coat hook	●	●	●	●	●	●
Front seatback trays	-	-	●	-	-	●
Rear seats – Second row 60/40 folding seats (fold/tumble/removeable in Tourneo, fold flat in Grand Tourneo)	●	●	●	●	●	●
Rear seats – Third row (Grand Tourneo 7-seat only, fold flat)	-	-	-	○	○	○

● = Standard, ○ = Option, at extra cost, □ = Part of an option pack, at extra cost.



Folding seats

The seats in the Tourneo Connect take adaptability to a new level. Second and third row rear seats in Grand Tourneo fold flat, creating a myriad of passenger and load-carrying possibilities. Second row seats in Tourneo fold and tip to maximise luggage area and all rear seat backs tilt to optimise passenger comfort. And in the Style and Zetec series the front passenger seat can be folded forward to form a convenient flat surface or load-through area.

Stowage space

Loadspace	Tourneo Connect			Grand Tourneo Connect		
	Style	Zetec	Titanium	Style	Zetec	Titanium
Load floor carpet (in place of rubber mat; Grand Tourneo 7-seat version only)	-	●	●	●	●	●
Cargo tie down hooks (4)	●	●	●	●	●	●
Removable package tray – rear	●	●	●	-	-	-
Cargo net kit (vertical, between seats and loadspace) - not available at launch	○	○	○	-	-	-
Cargo compartment net (horizontal, for floor)	-	●	●	-	●	●
Power point socket – 12V (located in load compartment)	-	●	●	-	●	●

● = Standard, ○ = Option, at extra cost, □ = Part of an option pack, at extra cost.

Rear-view camera

Select reverse and the view from the rear-view camera is displayed automatically in the internal mirror. Marker lines overlaid on the camera image indicate where the vehicle is heading.



Tow bar, fixed

Subjected to rigorous testing to ensure the highest safety standards. (Option and accessory)

¹Uses sensors.

¹Safety feature.

²Driver assistance feature.

1. Traction Control¹⁾

If wheel slip is detected at low speed, this system can distribute torque to the wheel with most traction.

2. Trailer Sway Control¹⁾

When it detects trailer sway, the system is designed to reduce engine torque and apply the brakes to the appropriate wheel(s) to help maintain control. (Standard with Ford factory-fit tow bar)

3. Hill Start Assist²⁾

Designed to prevent you from rolling down a slope temporarily when you move your foot from the brake pedal to the accelerator. It works in forward and reverse gears, so is ideal for towing when pulling heavy items and equipment for outdoor pursuits. (Standard)

4. Electronic Stability Control (ESC)²⁾

ESC is designed to help you maintain control in unpredictable driving conditions. It senses when the vehicle is deviating from your chosen line and aims to keep you on track by automatically regulating engine output and braking to each of the wheels. (Standard)

5. Emergency Brake Assist²⁾

Senses an emergency braking situation and increases the pressure within the braking system to ensure maximum stopping power is used. (Standard)



♦Note: A rear-facing child seat should never be placed in the front passenger seat when the Ford vehicle is equipped with an operational front passenger airbag. The safest place for children is properly restrained on the rear seat.

¶Uses sensors.

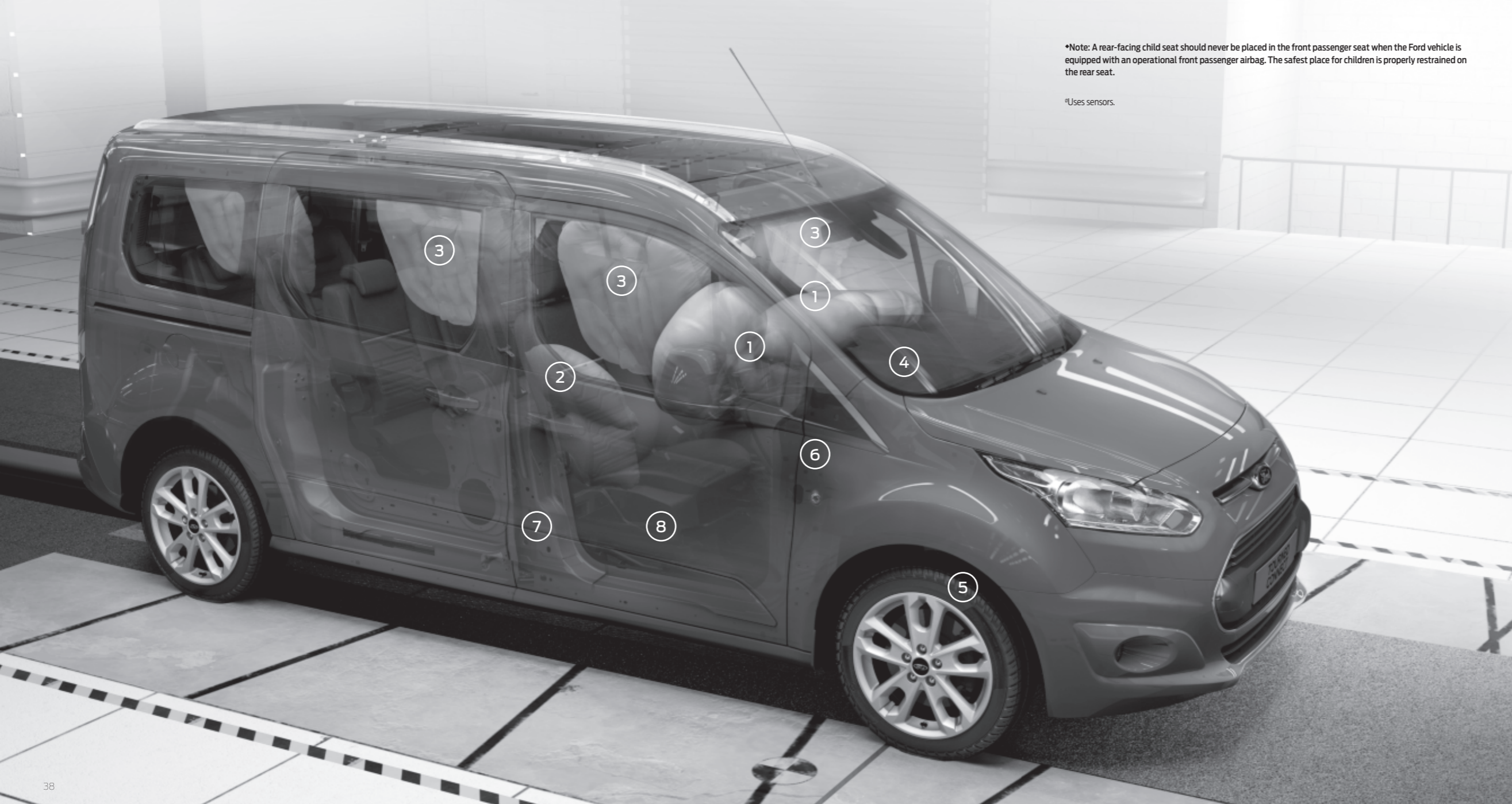

Intelligent Protection System[¶]

Ford's advanced IPS uses a range of sophisticated technologies designed to keep you protected, including an ultra-high strength steel safety cage, an anti-lock braking system with Emergency Brake Assist and front, side and curtain airbags.

The Ford Tourneo Connect IPS includes:

1. Driver and front passenger airbags♦
2. Driver and front passenger side impact airbags
3. Side curtain airbags for front and rear seats (including third row on 7-seater)
4. Collapsible steering column and pedals for optimised protection of driver's legs and feet
5. Electronic Stability Control with anti-lock brakes, electronic brake-force distribution and Emergency Brake Assist
6. Robust computer-optimised body structure with ultra-rigid safety cell and crumple zones
7. Pre-tensioners, load-limiting retractors and height-adjustable mounts on front seat belts
8. Anti-submarining seat bases

Active City Stop^{¶1}

Designed to help reduce the likelihood or consequences of your vehicle colliding with the vehicle in front in slow-moving traffic. Applies emergency braking if it is detected that a collision is likely. (Standard on Titanium)

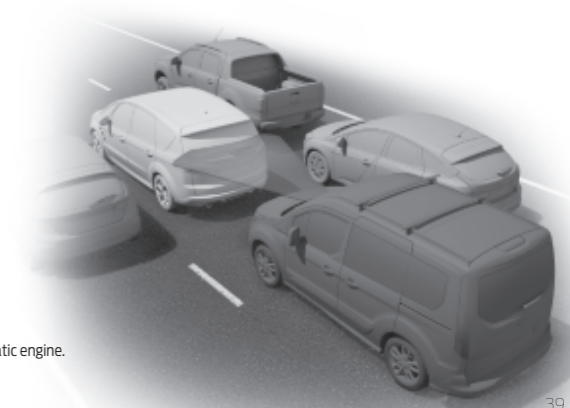

¹Not available with 1.6 petrol automatic engine.

Safety equipment

	Tourneo Connect			Grand Tourneo Connect		
	Style	Zetec	Titanium	Style	Zetec	Titanium
Safety and driver assistance						
Active City Stop (not available with 1.6 EcoBoost 150 PS automatic) ¹⁾	□	○	●/–	□	○	●/–
Anti-lock braking system (ABS) with Traction Control ¹⁾	●	●	●	●	●	●
Emergency Brake Warning ¹⁾	●	●	●	●	●	●
Electronic Stability Control (ESC)	●	●	●	●	●	●
Trailer Sway Control (TSC) (effective when Ford towbar is fitted) ¹⁾	○	○	○	○	○	○
Emergency Brake Assist (EBA) ¹⁾	●	●	●	●	●	●
Cruise Control with Adjustable Speed Limiting Device ²⁾	○	○	●	○	○	●
Hill Start Assist ²⁾	●	●	●	●	●	●
Tyre Deflation Detection System ²⁾	●	●	●	●	●	●
Airbag – Driver's ¹⁾	●	●	●	●	●	●
Airbag – Front passenger's* ¹⁾	●	●	●	●	●	●
Driver's side airbag (thorax and pelvis) ¹⁾	●	●	●	●	●	●
Passenger side airbag (thorax and pelvis) ¹⁾	●	●	●	●	●	●
Curtain airbag system for front and second row ¹⁾	●	●	●	–	–	–
Curtain airbag system for first, second and third rows ¹⁾	–	–	–	●	●	●
Seat belts – Driver and Passenger, with seat retractor pre-tensioners and load limiter ¹⁾	●	●	●	●	●	●
Seat belts – second row/third row, inertia reel lap and diagonal ¹⁾	●	●	●	●	●	●



Deflation Detection System¹⁾

Designed to alert you if a tyre's pressure is too low, such as in the case of a puncture. (Standard)

¹⁾ Driver assistance feature.

Security equipment

	Tourneo Connect			Grand Tourneo Connect		
	Style	Zetec	Titanium	Style	Zetec	Titanium
Security						
Door auto re-locking	●	●	●	●	●	●
Power door deadlocks	●	●	●	●	●	●
1 remote key + 1 plain key	●	–	–	●	–	–
Two remote keys (no plain key included as part of this pack)	○	●	●	○	●	●
Fleet Key (extra plain key)	○	–	–	○	–	–
Childproof rear door locks	●	●	●	●	●	●
Security – PATS (Passive Anti-Theft System)	●	●	●	●	●	●
Perimeter anti-theft alarm	○	○	○	○	○	○
Thatcham Category 1 alarm	○	○	○	○	○	○

● = Standard, ○ = Optional. ¹⁾ Safety feature, ²⁾ Driver assistance.

***Note: A rear-facing child seat should never be placed in the front passenger seat when the Ford vehicle is equipped with an operational front passenger's airbag.**

Integrated roof rails

Stylish roof rails enhance your Ford Tourneo Connect's appearance and versatility. (Standard on Titanium)



Mechanical features

	Touneo Connect			Grand Touneo Connect		
	Style	Zetec	Titanium	Style	Zetec	Titanium
Brakes						
Power assisted - discs all round	●	●	●	●	●	●
Fuel tank						
Ford Easy-Fuel capless refueling system	●	●	●	●	●	●
Fuel tank 60-litres	●	●	●	●	●	●
Engine						
Fuel Economy Package (standard on 100 PS petrol engine, not available on 150 PS petrol or 115 PS diesel). Includes stop/start system and Active Grille Shutter	● / ○ / -	● / ○ / -	○ / -	○ / -	○ / -	○ / -
Starter – Stop/Start system. Includes Smart Regenerative Charging. (Standard on 100 PS petrol engine)	● / ○ / -	● / ○ / -	○ / -	○ / -	○ / -	○ / -
Starter System -25°C	●	●	●	●	●	●
Speed Limiter – 70 mph	○	○	○	○	○	○
Steering						
Rake- and reach-adjustable steering wheel	●	●	●	●	●	●
Electronic Power Assisted Steering (EPAS)	●	●	●	●	●	●
Suspension and body						
Rear - Twistbeam	●	●	●	●	●	●
Base Payload Pack	●	●	●	-	-	-
Max Payload Upgrade Pack	-	-	-	●	●	●

● = Standard. ○ = Optional

See round corners.

Cornering lights

Designed to provide additional illumination of the area to the side of the vehicle when cornering, making night-time parking and turning safer. (Option on Zetec, standard on Titanium)

Fuel and performance

Touneo Connect	Euro Stage	Transmission	Maximum Power PS (kW)	Torque Nm	CO ₂ emissions (g/km) ⁹⁰	Fuel consumption mpg (L/100km) ⁹⁰			Performance ⁹	
						Urban	Extra Urban	Combined	Max. speed (mph)	0-62 mph (secs)
1.0 EcoBoost (100 PS (74 kW)) with standard Auto-Start-Stop	V	6 speed manual	100	170	129	44.1/6.4	55.4/5.1	50.4/5.6	103	13.0
1.6 EcoBoost (150 PS (110 kW))	V	6 speed automatic	150	240	184	25.9/10.9	44.8/6.3	35.3/8.0	110	10.4
1.6 Duratorq TDCi (95 PS (70 kW))	V	5 speed manual	95	230	130	50.4/5.6	61.4/4.6	56.5/5.0	100	15.2
1.6 Duratorq TDCi (95 PS (70 kW)) with optional Auto-Start-Stop	V	5 speed manual	95	230	120	57.6/4.9	64.2/4.4	61.4/4.6	100	15.2
1.6 Duratorq TDCi (115 PS (85 kW))	V	6 speed manual	115	270- 285**	130	50.4/5.6	61.4/4.6	57.6/4.8	102	13.1

*In 5th gear. *Ford test figures **With transient overboost **The declared fuel consumptions and CO₂ emissions are measured according to the technical requirements and specifications of European Directive 80/1268/EEC or the European Regulation (EC) 715/2007 amended by (EC) 692/2008. Fuel consumption and CO₂ emissions are specified for a vehicle type and not for a single car. The applied standard test procedure enables comparisons between different vehicle types and different manufacturers. In addition to the fuel efficiency of a car, driving behaviour as well as other non-technical aspects are very important in determining a car's fuel consumption and CO₂ emissions. CO₂ is the main greenhouse gas responsible for global warming. A guide on fuel economy and CO₂ emissions, which contains data for all new passenger car models, is available at any point of sale free of charge or can be downloaded from <http://carfueldata.dft.gov.uk>. **Note** All engines are Euro Stage V emissions. All petrol engines are equipped with a catalytic converter.

61.4 mpg*



International Engine of the Year
Ford 1.0 litre EcoBoost

*1.6 Duratorq 95PS diesel with optional Auto-Start-Stop

Ford EcoBoost petrol technology gives you the power of a bigger engine with the fuel economy and emissions of a smaller one. The latest ultra-efficient 1.0-litre EcoBoost engine produces an impressive 100 PS, yet it delivers a combined fuel consumption of just 50.4 mpg and CO₂ emissions of only 129 g/km.

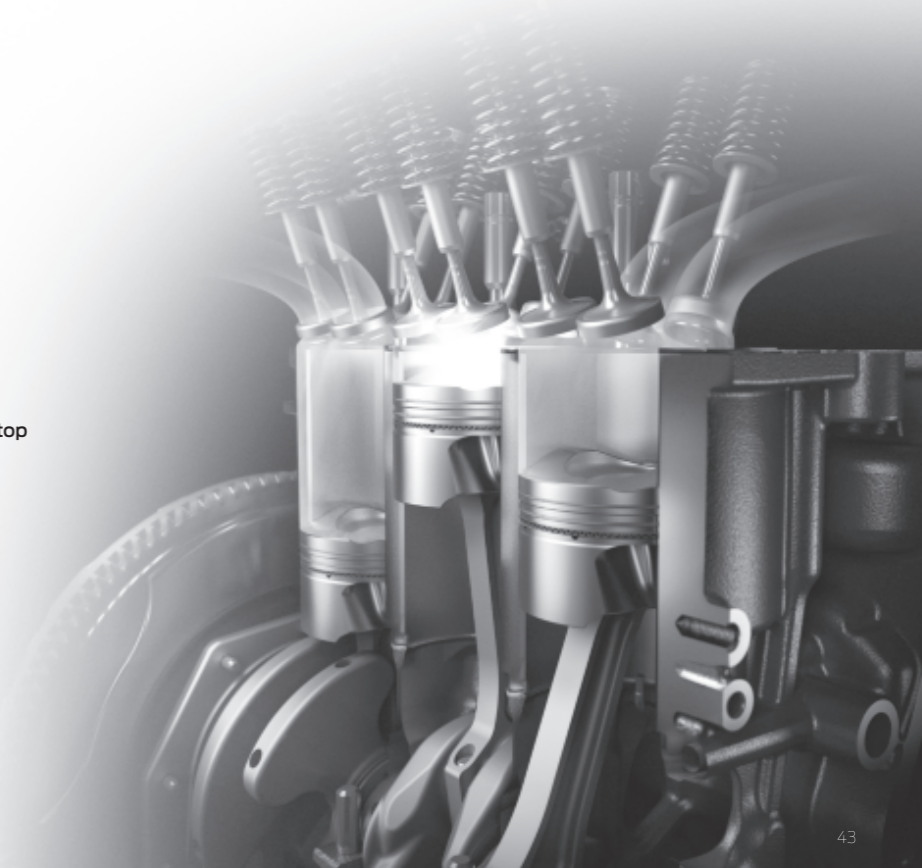

Weights and loads

	Style	Zetec	Titanium	Euro Stage	Kerbweight (kg)*	Gross Vehicle Mass (kg)	Gross Train Mass (12%)* (kg)	Max. Towable Mass (braked) (12%)* (kg)	Max. Towable Mass (unbraked) (kg)
Tourneo Connect									
1.0 EcoBoost (100 PS (74 kW))	●	●	–	V	1429	2010	2910	900	750
1.6 Duratec (150 PS (110 kW))	–	–	●	V	1478	2045	2945	900	750
1.6 Duratorq TDCi (95 PS (70 kW))	●	●	●	V	1468	2045	3145	1100	750
1.6 Duratorq TDCi (115 PS (85 kW))	–	●	●	V	1477	2055	3155	1100	750
Tourneo Connect Grand – 7 seats									
1.6 Duratorq TDCi (95 PS (70 kW))	●	●	–	V	1524	2300	3145	845	750
1.6 Duratorq TDCi (115 PS (85 kW))	–	●	●	V	1533	2310	3145	845	750

***Payload** = Gross vehicle mass, less kerb mass. All kerb masses quoted in this brochure are subject to manufacturing tolerances and are for Style models with minimum equipment. Zetec and Titanium models will have greater kerb masses and, therefore, lower payloads due to the increased amount of standard equipment. Any additional options specified on the vehicle will reduce the payload accordingly. *Represents the lightest kerbweight assuming full fluid levels and 90% fuel levels, subject to manufacturing tolerances and options, etc., fitted. **Note** All diesel engines are fitted with a standard vDPF (vaporiser Diesel Particulate Filter).

Dimensions

	Tourneo Connect	Grand Tourneo Connect 5-seat	Grand Tourneo Connect 7-seat
A Overall length	4418	4818	4818
B Overall width with mirrors	2137	2137	2137
C Overall height (unladen)	1852	1845	1840
G Side door entry width	612	839	839
I Luggage space width between wheel arches	1192	1149	1149
K Luggage space width	1477	1477	1477
M Luggage floor to roof	1245	1234	1072
O Luggage space length (5-seat mode)	913	1305	1264
O Luggage space length (2-seat mode)	1828	2179	2179
T Luggage capacity (5 seat mode, laden to package tray/laden to roof)	520/1029	- /1529	- /1287
T Luggage capacity (2-seat mode, laden to roof)	2410	2761	2620
T Luggage capacity (7-seat mode, minimum/maximum)	–	–	200/322
Turning circle (m)			
Kerb to kerb	11.3	12.2	12.2

All dimensions (shown in mm) are subject to manufacturing tolerances and refer to minimum specification models and do not include additional equipment. These illustrations are for guidance only. Dimensions may vary dependent on the model and equipment fitted.

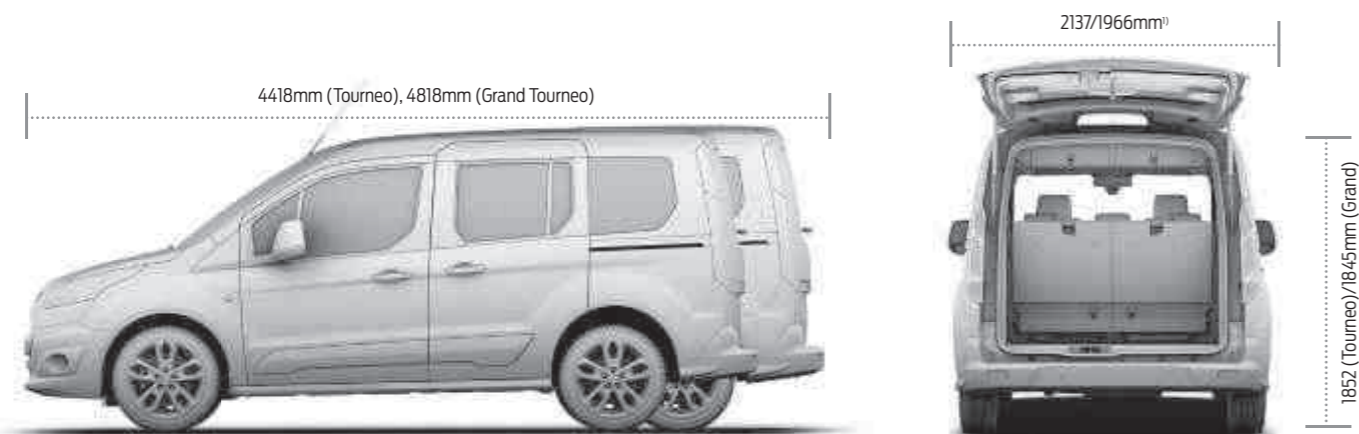

1) Mirrors out/folded

Enhanced versatility



Thule® roof box*, lockable

Can be opened from both sides for convenient loading. Available in different sizes, Pacific 200 is shown. (Accessory)



Thule® roof ski/snowboard carrier Deluxe 727* – lockable and extendable

Innovative, fully-lockable ski carrier suitable for up to six pairs of skis or four snowboards. Comfortable slide-out function extends outside the roof area for easy access to your ski equipment. (Accessory)

Thule® bike carriers

Choose from a range of different carriers to be mounted on the roof or the tow bar*. Bicycle carrier Pro Ride 591 is shown. (Accessory)



Roof rails

Stylish roof rails enhance your Ford Tourneo Connect's appearance and versatility. (Option)

Roof crossbars, for roof rails

Aerodynamic-shaped aluminium profiles, for all attachments such as roof boxes, bike carriers, ski racks, etc. (Accessory)

Tow bar, detachable*

Including 13 pin electrical connector kit. (Option and accessory) Not available until September 2014. Also available as a fixed tow bar. (Accessory)

+Please see back cover for warranty information.
*Not available with full exterior styling kit.

Colour and trim

Model	Style	Zetec	Zetec	Titanium	Titanium
	Standard	Standard	Optional	Standard	Optional
Seat facing trim and colour	Traxon in Charcoal Black	Route in Charcoal Black	Route in Medium Stone	Chicane in Charcoal Black	Chicane in Medium Stone
Seat bolster trim and colour	Max in Charcoal Black	Max in Charcoal Black	Max in Medium Stone	Malt in Charcoal Black	Malt in Medium Stone
Door trim and colour	PP in Charcoal Black	PP in Charcoal Black	PP in Charcoal Black	Max in Charcoal Black	Max in Charcoal Black
Centre stack bezels/Door handle deco strips	Pegasus/Black	Phoenix Silver/Radiant Silver	Phoenix Silver/Radiant Silver	Nebula/Radiant Silver	Nebula/Radiant Silver
Upper/lower instrument panel	Charcoal Black/Charcoal Black	Charcoal Black/Charcoal Black	Charcoal Black/Medium Stone	Charcoal Black/Charcoal Black	Charcoal Black/Medium Stone
Solid body colours					
Frozen White	●	●	●	●	●
Blazer Blue	●	●	●	●	●
Race Red	●	●	●	●	●
Metallic body colours*					
Moondust Silver	○	○	○	○	○
Panther Black	○	○	○	○	○
Deep Impact Blue	○	○	○	○	○
Tectonic Silver	○	○	○	○	○
Midnight Sky (until July 2014)	○	○	○	○	○
Burnished Glow	○	○	○	○	○
Solar	○	○	○	○	○
Magnetic (from Aug 2014)	○	○	○	○	○

● = Standard. ○ = Optional *Metallic paint is an option at extra cost.



12-year perforation warranty

The new Tourneo Connect owes its durable exterior to an advanced multi-stage painting process. From the wax-injected steel body sections to the hard-wearing top coat, new materials and application processes ensure it will retain its good looks for many years to come.

The Ford Tourneo Connect is covered by the Ford Corrosion Protection Warranty for 12 years from the date of first registration. Subject to terms and conditions.

Bodystyle: _____ Series: _____

Engine: _____

Transmission: _____

Colour: _____

Trim: _____

Wheels: _____

Audio: _____

Options: _____

Option Packs: _____

Accessories: _____

Finance: _____

Choose

Use the form opposite to specify your new car right down to the wheels, audio, options and accessories, then take it to your Ford Dealer.

You can also specify your new car online using the Ford Configurator. It lets you instantly see what your car will look like – inside and out – from multiple angles. And a tally of your choices and their prices helps you keep to your budget. Visit www.ford.co.uk/SBE/ConfigureYourVehicle

Finance

When it comes to financing your car, our size and expertise means we're well placed to provide you with a wide range of finance products.

Ford Credit** provides straightforward finance products for your car whether you are a private or business user.

Ford Lease[^] provides simple tailored funding solutions for your business. Business users only. For more information about our finance products visit ford.co.uk

Drive

When you drive away in your new car, we're with you all the way. Ford has the largest authorised service network in the UK to help you keep your car in the best condition.

And should your new Ford ever require accident repair, a Ford Accident Repair Centre is the best place to get your car back to its pre-accident condition and on the road as quickly as possible.

Contact

Ford Credit Customer Services 0845 712 5490

Ford Lease Customer Services 0844 600 1405

** Finance subject to status. Guarantee/indemnities may be required. Freepost Ford Credit.

[^] Ford Lease is provided by ALD Automotive Ltd, trading as Ford Lease, Oakwood Park, Lodge Causeway, Fishponds, Bristol, BS16 3JA. ALD Automotive is registered in England No. 987418. For the purposes of the Data Protection Act 1998 the data controllers in relation to any information you supply are Ford Motor Company Limited, FCE Bank plc and ALD Automotive. Finance subject to status. Guarantees and indemnities may be required. ALD Automotive is authorised and regulated by the Financial Conduct Authority in respect of general insurance products.

Insurance Groups

	Style	Zetec	Titanium
Tourneo			
1.0 EcoBoost (100PS (74kW))	4E	6E	
1.6 Eco Boost (150PS (110kW))			11E
1.6 Duratorq TDCi (95PS (70kW))	6E	6E	7E
1.6 Duratorq TDCi (115PS (85kW))		8E	9E
Grand Tourneo			
1.6 Duratorq TDCi (95PS (70kW))	6E	7E	
1.6 Duratorq TDCi (115PS (85kW))		9E	9E

E = Exceeds security requirement for model concerned and group rating has been reduced. Insurance ratings are issued by the Association of British Insurers and are shown above on the new 1-50 rating scales.

Illustrations, descriptions and specifications. This catalogue was correct at the time of going to print. However, Ford policy is one of continuous product development. The right is reserved to change specifications, colours and prices of the models and items illustrated and described in this publication at any time. For the latest details always consult your Ford Dealer. **Optional equipment.** Throughout this publication, wherever a feature is described as being an 'Option' or 'Option Fitment/Pack' etc, you should assume that it will be at extra cost to the base vehicle, unless specifically stated to the contrary. All models and colour combinations are subject to availability. **Note.** Some images portrayed are of a pre-production model and/or are computer generated, therefore, the design/features on the final version of the vehicle may differ in various respects. In addition, some of the features shown on the vehicles may be optional. **Note.** This brochure contains both original Ford accessories as well as a range of products from our suppliers. **+**The identified accessories are carefully selected third party supplier branded accessories which do not come with a Ford warranty but are instead covered by the third party supplier's own warranty, the details of which can be obtained from your Ford Dealer. **Note.** The Bluetooth® word mark and logos are owned by the Bluetooth SIG, Inc. and any use of such marks by Ford Motor Company is under licence. The iPod word mark and logos are the property of Apple Inc. Other trademarks and trade names are those of their respective owners. **Note.** Some driver assistance features and safety features described in this brochure are designed to function using sensors, whose performance may be affected under certain weather or environmental conditions.

The Government fuel figures do not express or imply any guarantee of the fuel consumption of any particular vehicle. The vehicles themselves have not been tested and there are inevitably differences between individual vehicles of the same model. In addition, a vehicle may incorporate particular modifications. Furthermore, the driver's style and road and traffic conditions, as well as the extent to which the vehicle has been driven and the standard of maintenance, will affect its fuel consumption. **Insurance groups** are only as recommended by the Association of British Insurers. You should always consult your insurance adviser for confirmation.



Ford and BP – working together to reduce fuel consumption and emissions.



Collect Nectar points at participating Ford Dealers and Authorised Repairers now. So take a look at the latest Ford Service Promotions by visiting the Owner Services section within www.ford.co.uk.



Ford One Call

In the unlikely event that your Ford Dealer can't help you or if you need to speak to us directly, call 0203 564 4444

Ford Rental - local service nationwide

Car and Van rental from our latest model range. Contact your local Ford Dealer for more information

Ford Motability

Our dedicated care centre provides free information on all motoring and mobility issues, including special offers for HRDLA and Motability recipients. Call free on 0845 6040019

Finance

Ford Credit Customer Services 0845 712 5490
Ford Lease Customer Services 0844 600 1405

Ford Warranty and Servicing Plans

3-year/100,000 mls* Ford Protect Classic Plan Warranty ●

1-year/unlimited mls* Ford Assistance Roadside Cover (Europe) ●

3-year/100,000 mls * Paint Warranty ●

12-year/unlimited mls Perforation Warranty ●

● = Standard, ○ = Optional, at extra cost

*From the date of first registration. Subject to terms and conditions.

All Fiesta models

Published by Ford Motor Company Limited, Brentwood, Essex, England. Registered in England No. 235446.

FA 1591
BJN 202787. FoE H61E.
PN 377509/1213/15m/GBR en.

July 2013.

© Ford Motor Company Limited.



To configure your Ford online visit

www.ford.co.uk/SBE/ConfigureYourVehicle

To look at finance for your Ford visit www.fordcredit.co.uk/BuyingAndProtectingYourFord

Business users visit www.ford.co.uk/FordForBusiness



www.ford.co.uk



Go Further