



**The new Audi A3 Cabriolet**

Pricing and Specification Guide

Valid from October 2013



# Personalising your new Audi A3 Cabriolet

This guide has been designed to help you tailor and price your new Audi A3 Cabriolet quickly and logically. At the back, you will find information on CO2 emissions-based taxation and the other services offered by Audi, including Finance and Insurance. You can also configure your new Audi A3 Cabriolet online at [audi.co.uk](http://audi.co.uk)

## The new Audi A3 Cabriolet

Engines	12
Transmission	13
Efficiency	14

## Model details and prices

SE model equipment	18
Sport model equipment	22
S line model equipment	24
Model prices	26

## Colour and upholstery

Paint	28
Upholstery	32
Colour and trim guide	42
Seats	43

## Inlays

## Options

Wheels, tyres and suspension	48
Packages	54
Audio and communication	56
Interior equipment	58
Exterior equipment	62
Safety and security	66

## Looking after your Audi

Audi Complete and Service Plan	70
Warranty	73
Accessories	74
Merchandise	75
Audi Difference	76

## Technical details

Technical data	78
Dimensions	79
Pricing and Additional information	80





## Vorsprung durch Technik

Three words that express the very essence of Audi. Vorsprung durch Technik isn't a slogan, it's our way of seeing the world. It is the driving force behind our history of innovation that continues into the 21st century. Indeed, many technologies that Audi pioneered remain in our cars today. Some are milestones in the history of the motorcar.

From our beginnings in 1899, to the Auto Union team's Grand Prix successes in the 1930s and our more recent wins at Le Mans, we have always been at the forefront of the motor industry.

Vorsprung durch Technik makes us who we are. To see more of its influence, just read on.









## **The new Audi A3 Cabriolet: Vorsprung durch Technik in its genes**

With its innovative design and sophisticated technology, the new Audi A3 Cabriolet is the perfect example of Vorsprung durch Technik. It's available with a choice of advanced petrol and diesel engines, from the 1.4 TFSI® with cylinder-on-demand technology to the 2.0 TDI® – all of which deliver exceptional efficiency and performance. And there's also a wide range of equipment and accessories to choose from, placing you behind the wheel of a car that suits you completely.













## **The new A3 Cabriolet interior story**

We've introduced a number of finishing touches to the interior of the new Audi A3 Cabriolet to make your driving experience both comfortable and unique. You'll find an impressive attention to detail in everything from the 5.8" slimline, electrically extending colour display screen to the optional luxurious leather seating, which means that every journey you make will be a personal one.



# Engines

## Petrol

FSI® direct-injection technology is a unique Audi innovation that was originally developed for the Le Mans 24-hour endurance race to deliver more power and torque, as well as enhanced fuel efficiency. Precisely the right amount of fuel and air are injected into the combustion chambers, enabling the engine to 'breathe' more easily. It results in reduced heat loss and increased output, with around a 15% reduction in fuel consumption and significantly lower exhaust emissions. We've also developed TFSI®, with turbocharging – giving cars an extra injection of power.

## Diesel

We introduced TDI® to the roads in 1989, and since then, we've continuously refined it, including developing common-rail technology. Under this system, a series of piezo injectors uses electrical charge to precisely control the amount of fuel injected into the engine. As well as reducing noise, this allows combustion to happen at a lower temperature, with less oxygen, which lowers emissions.



# Transmission

## **S tronic®**

Driving is all about thinking ahead, which is just what the S tronic® dual-clutch transmission does. It works almost as two separate systems, one engaging the odd-numbered and the other the even-numbered gears. So when you're accelerating in second, it has third gear waiting for you. And once you make the switch, it's already thinking about fourth. With two clutches working together, you can change gears almost instantly while experiencing smooth, uninterrupted power.

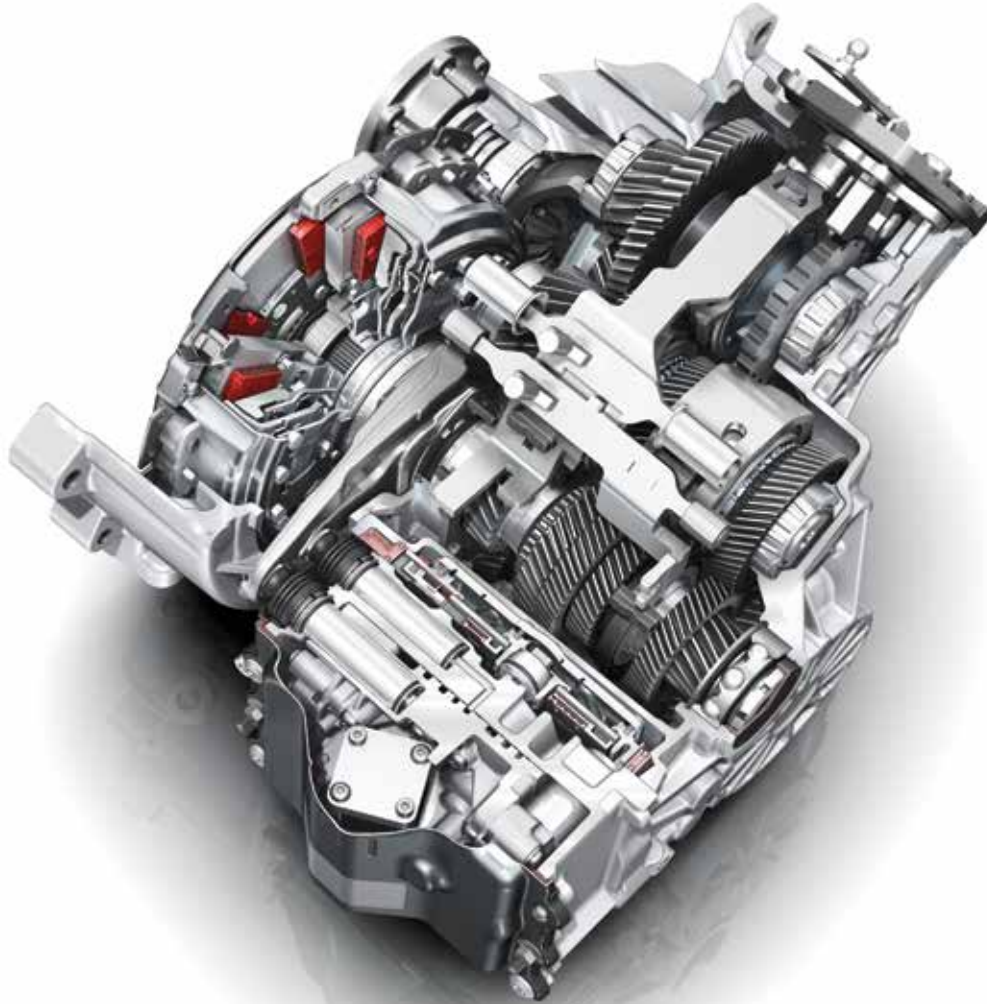

## Efficiency

At Audi, doing less is something we're trying to do more of. We're working to use less fuel, release less CO<sub>2</sub> and waste less energy. It's why we've incorporated a number of more efficient technologies into the Audi A3 Cabriolet.

### **TDI® and FSI®**

Inside the engine of the Audi A3 Cabriolet you'll find the same advanced fuel-injection technology that's driven us to win after win at Le Mans. With TDI® and FSI®, fuel is injected directly into the engine's chambers so that combustion is timed right down to the millisecond. As a result, waste is minimised and you get the most from every last drop of fuel.

### **Gear-change indicator**

Small changes to your driving style can have a big impact on your fuel economy. The gear-change indicator in the Audi A3 Cabriolet is there to indicate the optimum gear to use for any given speed, encouraging early upshifts to ensure you don't burn more fuel than is necessary.

### **Aerodynamics**

A car's shape is one of the most important factors that influences its efficiency. It's why we've worked to make the Audi A3 Cabriolet as aerodynamic as possible.







### **Audi cylinder-on-demand**

Dynamic performance does not necessarily equate to higher consumption – as the 1.4 TFSI® cylinder-on-demand engine proves. Using advanced cylinder-on-demand technology to automatically shut down two of the four cylinders when the engine is operating at lower loads, particularly when cruising on the motorway or in city traffic, you benefit from the efficiency and low emissions of a comparable diesel engine. Out on the open road, meanwhile, the instantaneous power of TFSI®, combining turbocharging with petrol direct injection, is ready and waiting.

### **Recuperation**

When a vehicle brakes, the discs convert the kinetic energy into thermal energy, which is wasted as it cannot be used. With a recuperation system, like the one that is fitted as standard on all A3 models, the kinetic energy is converted into useful electrical energy. The way it works is simple. While the car is coasting or braking, the alternator voltage is raised above the level of the basic electrical system, which enables the alternator to generate electrical energy and store it temporarily in the battery. When the vehicle accelerates, this energy is used to relieve the load on the alternator, resulting in a fuel saving of up to 3%.









# SE model equipment

New A3 Cabriolet SE models have the following items of standard equipment

## Engine and transmission

**Efficiency programme in the Driver's Information System (DIS)** – provides the driver with fuel-saving tips, a gear-change indicator on manual models and details of other vehicle functions that consume fuel

**Start-Stop system** with energy recuperation

## Wheels, tyres and suspension

**16" x 7J '10-spoke' design alloy wheels** with 205/55 R16 tyres

**Anti-theft wheel bolts**

**Electromechanical parking brake** – includes parking brake function when the car is stationary, auto-release function to assist when pulling away and emergency braking function

**Electromechanical power steering**

**Space-saving spare wheel** – for temporary use

## Audio and communication

**5.8" QVGA colour display screen** – electrically extending, slimline design, with 400 x 240 pixel resolution

**8 passive speakers** in total, at the front and rear with a total output of 80 watts

**MMI radio which includes:**

- Single CD player and two SDXC memory card readers (up to 2TB) which are both MP3, WMA and AAC compatible
- MMI control panel
- FM and AM (MW) reception
- 50-station memory with dynamic station list
- Speed-dependent volume control
- TP memo, which automatically saves traffic news when driving

**Audi Music Interface (AMI)** – provides connection to Apple iPod from 4th generation and Apple iPhone, as well as USB storage media and MP3 players. Located in the centre console and operated using the MMI control panel or the multi-function steering wheel

**Bluetooth interface** – for hands-free mobile phone connectivity and Bluetooth audio streaming (depending on compatibility of mobile phone)

**DAB digital radio reception.** Integrated into the MMI, receives digitally transmitted radio stations in addition to the range of analogue stations. Displays music track, artist and radio programme. Capable of 'DAB slideshow' where transmitted. Reception dependent on local digital network

**Driver's Information System (DIS)** – 3.5" monochrome display in the dashboard binnacle. The DIS shows the radio frequency/station or track title, telephone control menu and other display information from the infotainment system such as navigation (if fitted). Includes an on-board trip computer with short and long-term trip memory, outside temperature display, digital speedometer and door or boot-open warning. Also includes a rest recommendation system which monitors steering movements and pedal usage and warns the driver when a rest might be required

**Integrated aerial.** Concealed under the side panel trim so that it does not disturb the body line of the Audi A3 Cabriolet and provides optimum reception quality

**Preparation for SD card-based navigation system** – allows maps to be retro-fitted using parts from Audi Genuine Accessories



## Seats

**Convenience entry** – enhanced front seat folding function for easy access to the rear compartment  
**ISOFIX child seat mounting** for front passenger (with airbag deactivation) and rear seats with top tethering

**Marathon cloth upholstery** – available in black or titanium grey. The seat centre section is in Marathon cloth design and the seat side sections, head restraints and door and rear side trims are in plain cloth

**Split-folding rear seats** – 50/50 or all

**Standard front seats**, with manual forward, backwards and backrest angle adjustment, seat height adjustment (on driver's and front passenger's side) and also head restraint adjustment

## Interior

**4-spoke leather-trimmed multi-function steering wheel** with gear-shift paddles on S tronic models, adjustable for height and reach

**Air vents in aluminium look**, which can be adjusted from wide diffuse air distribution to a particular spot diffuse

**Cup holders** – two in the front located in the centre console in front of the gear knob and two in the rear located in between the two rear seats

**Electric front and rear windows**

**Front and rear floor mats** – in velour to match interior colour

**Front centre armrest** with angle and lengthways adjustment

**Hood lining** – colour-coordinated with the interior in black or lunar silver

**Inlays** in micrometallic silver

**Interior lighting** – front and rear with delayed switch-off and contact switches on all doors. Also includes glove box and luggage compartment light

**Lashing points** – four in luggage compartment, to prevent movement of luggage and other objects; also act as attachment points for the optional luggage securing net

**Light and rain sensor package** – automatically switches the dipped beam headlights and windscreen wipers on/off depending on the light and rain conditions. Includes coming home/leaving home function which delays the deactivation of the front and rear lights after locking and automatic activation of the lights when unlocking. The package also includes a windscreen with sunband for improved insulation and acoustic glass for reduced outside noise

**Manual air conditioning**

**Smoking package** with cigarette lighter, 12V socket in the centre console and an ashtray with the Audi rings

**Storage compartments** in the door side trims, in the centre console and under the front driver's seat

**Sun visors** – folding and swivelling, on driver's and front passenger's side, with covered vanity mirror



Driver's Information System (DIS)



Standard seat\* in Milano leather with Pashmina beige upholstery



Manual air conditioning and air vents in aluminium look

\*Image shown also includes optional Milano leather and under-seat storage which is part of the storage package, both available at additional cost

# SE model equipment

continued

## Exterior equipment

**Aluminium window trims** – framing the exterior side windows

**Automatic fabric hood in black** with a space-saving k-folding design, an integrated heated rear window and an elegant hood compartment with an aluminium trim strip surround. Controlled via a button in the centre console, the hood opens and closes in less than 18 seconds, up to a speed of 31mph

**Door mirrors** – electrically adjustable and heated with built-in LED side indicators and painted in body colour

## Front fog lights

**Halogen headlights** with electric headlight range control and daytime-running lights

## Heated windscreen washer jets

**Model and engine technology (TDI or TFSI) badges at the rear**

**Rear lights** – with reversing lights in white and rear fog lights, including high-mounted third brake light and LED number plate light

**Exhaust tailpipe** – double tailpipes on the left

**Washer fluid level indicator**

## Safety and security

**Active bonnet** – in the event of contact with a pedestrian in a speed range of 16-34mph, the active bonnet creates more space between the bonnet and the engine to reduce the consequences of the accident

**Active roll-over protection system** – only deploys if the vehicle rolls over

**Adaptive brake light** – the brake light flashes during an emergency stop to warn following traffic, hazard warning lights automatically activated if vehicle comes to a standstill

**Airbags** – driver, front passenger and front side airbags with knee airbag for the driver. Includes a front passenger airbag deactivation switch

**Anti-Slip Regulation (ASR)**. Reduces engine power to prevent the drive wheels from spinning, resulting in more stability and improved traction

**Anti-lock Brake System (ABS) and Electronic Brake-force Distribution (EBD)**. Hydraulic brake assist, disc brakes at front and rear, ventilated at front

**Electronic Differential Lock (EDL)**. On surfaces with varying levels of grip, this start-off assistant automatically brakes the driven wheels in slippery conditions, thereby ensuring smooth, powerful progress

**Electronic Stabilisation Control (ESC)**. Ensures greater stability in hazardous situations through targeted braking of individual wheels and intervention in the engine management system and helps to stabilise the vehicle by changing the steering torque

## First-aid kit

**Secondary collision brake assist** – in the event of an accident, this function automatically brakes the car to prevent secondary collisions

**Remote central locking** with two fold-away keys

**Rest recommendation system** – analyses driving behaviour based on steering, pedals and gear lever movements. If the system detects a change in driving patterns it can, via audio and visual effects, notify the driver of the possible need to take a break

**Seat belt reminder** for all seats

**Thatcham Category 1 alarm and immobiliser**, with tow-away protection and interior monitoring (both of which can be switched off)

**Tool kit and car jack**

**Warning triangle**



Automatic fabric hood in black



Aluminium window trims



Door mirrors – electrically adjustable and heated with built-in LED side indicators and painted in body colour





Image shows the A3 Cabriolet SE model with optional Ice silver, metallic paint (P5) and LED light package

# Sport model equipment

## In addition to SE model equipment

**Basic RRP**  
£1,020.83

**Total RRP inc VAT**  
£1,225.00

### Wheels, tyres and suspension

17" x 7.5J '5-arm' design alloy wheels with 225/45 R17 tyres

**Audi drive select** changes vehicle characteristics by adapting power steering assistance, accelerator and gear-shift response (for models with S tronic). The system also influences other optional equipment through five available modes: comfort, auto, dynamic, efficiency and individual. The efficiency mode adapts the engine characteristics, enables free-wheeling mode with the S tronic transmission and engages the climate control and the optional adaptive cruise control into an efficient fuel-saving setting

**Sports suspension**, lowered by 15mm with stiffer suspension and damping for more direct contact with the road and sporty handling. Deselection of Sports suspension is available as a no-cost downgrade from Sports suspension and, if chosen, the Sports suspension lowering is removed and the suspension is returned to the standard ride height and damping

### Audio and communication

**Colour Driver's Information System** – offers the same functionality as the Driver's Information System (DIS) but with a high-resolution colour display

### Seats

**Front Sports seats**, with shaped side bolsters for better lateral support when cornering, manual forward/backward and backrest angle adjustment, manual adjustment of the seat height (on the driver's and front passenger side) and the head restraint as well as the seat-cushion angle adjustment and extendable thigh support

**Rallye cloth upholstery** – seat centre sections in Rallye cloth design. The seat side bolsters, head restraints as well as door and rear side panel inserts are in single-colour cloth

### Interior equipment

**3-spoke leather-trimmed Sports multi-function steering wheel**, with gear-shift paddles on S tronic models

### Aluminium door sill trims

**Aluminium interior elements** – on the vents, glove compartment, mirror adjustment switches, window control switches, frame around the inside door handle, coin box, control buttons for the parking brake and the hold assist button (if fitted)

**Dual-zone electronic climate control** with sunlight-dependent control, separate pre-selectable control for driver and front passenger. Electronically regulates the air temperature, air flow rate and air distribution. Automatic recirculation mode by means of air quality sensor, combined filter, rear vents and humidity regulation for more efficient climate control

**Inlays** in Aluminium mistral silver

### Exterior equipment

**Chrome exhaust tailpipe trims**

**Chrome front fog light surrounds**

**Fully automated acoustic hood** made out of insulated, three-layered fabric. Opens in just 17 seconds and closes in just 18 up to road speeds of 31mph



17" x 7.5J '5-arm' design alloy wheel



Sports seats in Black Rallye cloth\*



3-spoke leather-trimmed Sports multi-function steering wheel



Dual-zone electronic climate control



Image shows the A3 Cabriolet Sport model with optional Phantom black, pearl effect paint (L8), 17" '5-spoke' design alloy wheels (COX) and Xenon light package (WB6)



# S line model equipment

## In addition to Sport model equipment

**Basic RRP**  
£1,791.67

**Total RRP inc VAT**  
£2,150.00

### Wheels, tyres and suspension

18" x 8J '5-parallel-spoke' design partly polished alloy wheels with 225/40 R18 tyres

**Sports suspension**, lowered by 15mm (same suspension as Sport). Deselection of Sports suspension is available as a no-cost downgrade, and if selected, the Sports suspension lowering is removed and the suspension is returned to the standard ride height and damping. S line Sports suspension, lowered by an additional 10mm, is also available as a no-cost upgrade

### Seats

**Biathlon cloth/leather upholstery** with S line embossing and contrasting silver stitching on the upholstery, steering wheel and gear knob gaiter

### Interior equipment

Door sill trims with S line logo

Illuminated vanity mirrors

Inlays in matt-brushed aluminium

Perforated leather gear knob

**Flat-bottomed S line 3-spoke leather multi-function steering wheel**, with perforated leather grips and gear-shift paddles on S tronic models

**Storage and luggage compartment package** – includes storage nets on the backs of the front seat back rests, storage net in the front passenger footwell, 12V socket in the rear centre console and storage compartment under the rear seat. In the luggage compartment there is an additional multi-fastening point, net in the side compartment, luggage securing net, a 12V socket and additional LED lighting

### Exterior equipment

Front fog light surrounds in high gloss black

Radiator grille in high gloss black

S line badges on the front wings

**S line design body styling comprising:**

- S line front bumper
- S line rear diffuser with Platinum grey insert
- S line side sills

**Xenon Plus headlights** with automatic/dynamic headlight range control, LED daytime-running light strip and headlight washers. Also includes LED rear lights, brake lights and rear indicators



18" x 8J '5-parallel-spoke' design partly polished alloy wheel



Front fog light surrounds and radiator grille in high gloss black



Xenon Plus headlights with LED daytime-running light strip



Rear lights, brake lights and rear indicator all featuring LED technology



Image shows the A3 Cabriolet S line model with optional Daytona grey, pearl-effect paint (6Y)

## A3 Cabriolet SE

Engines	Power	Transmissions	CO <sub>2</sub> g/km	Basic RRP	Total RRP inc VAT	Recommended OTR
1.4 TFSI*	140PS	6-speed manual	114	£20,954.17	£25,145.00	£25,790.00
2.0 TDI	150PS	6-speed manual	110	£22,162.50	£26,595.00	£27,240.00

## A3 Cabriolet Sport

Engines	Power	Transmissions	CO <sub>2</sub> g/km	Basic RRP	Total RRP inc VAT	Recommended OTR
1.4 TFSI*	140PS	6-speed manual	114	£21,975.00	£26,370.00	£27,015.00
1.8 TFSI	180PS	7-speed S tronic	133	£24,583.33	£29,500.00	£30,270.00
2.0 TDI	150PS	6-speed manual	110	£23,183.33	£27,820.00	£28,465.00

## A3 Cabriolet S line

Engines	Power	Transmissions	CO <sub>2</sub> g/km	Basic RRP	Total RRP inc VAT	Recommended OTR
1.4 TFSI*	140PS	6-speed manual	114	£23,766.67	£28,520.00	£29,165.00
1.8 TFSI	180PS	7-speed S tronic	133	£26,375.00	£31,650.00	£32,420.00
2.0 TDI	150PS	6-speed manual	110	£24,975.00	£29,970.00	£30,615.00

\*With cylinder-on-demand technology

**Please note:** The maximum power output figures are quoted in PS (or Pferdestärke, which is the metric equivalent of brake horsepower). To convert to brake horsepower, divide the PS figure by 1.0139.

**Recommended On-The-Road (OTR) retail prices include:** delivery charge, half a tank of fuel, number plates at £590.00 (inc. VAT), Road Fund Licence (which may vary depending on model/transmission – see page 79 for details) and first registration fee at £55.00. Vehicle Excise Duty correct at time of going to print, but this may alter to reflect any change in the applicable VED rate.

RRP – Recommended Retail Price. VAT is calculated at 20% but this may alter to reflect any change in the applicable VAT rate.







# Paint

We believe that every part of your car should have a personal touch. Which is why you can choose from a wide range of paint colours and finishes, from standard shades to metallic and pearl effects. We can even mix a customised colour for you to create the perfect fit.

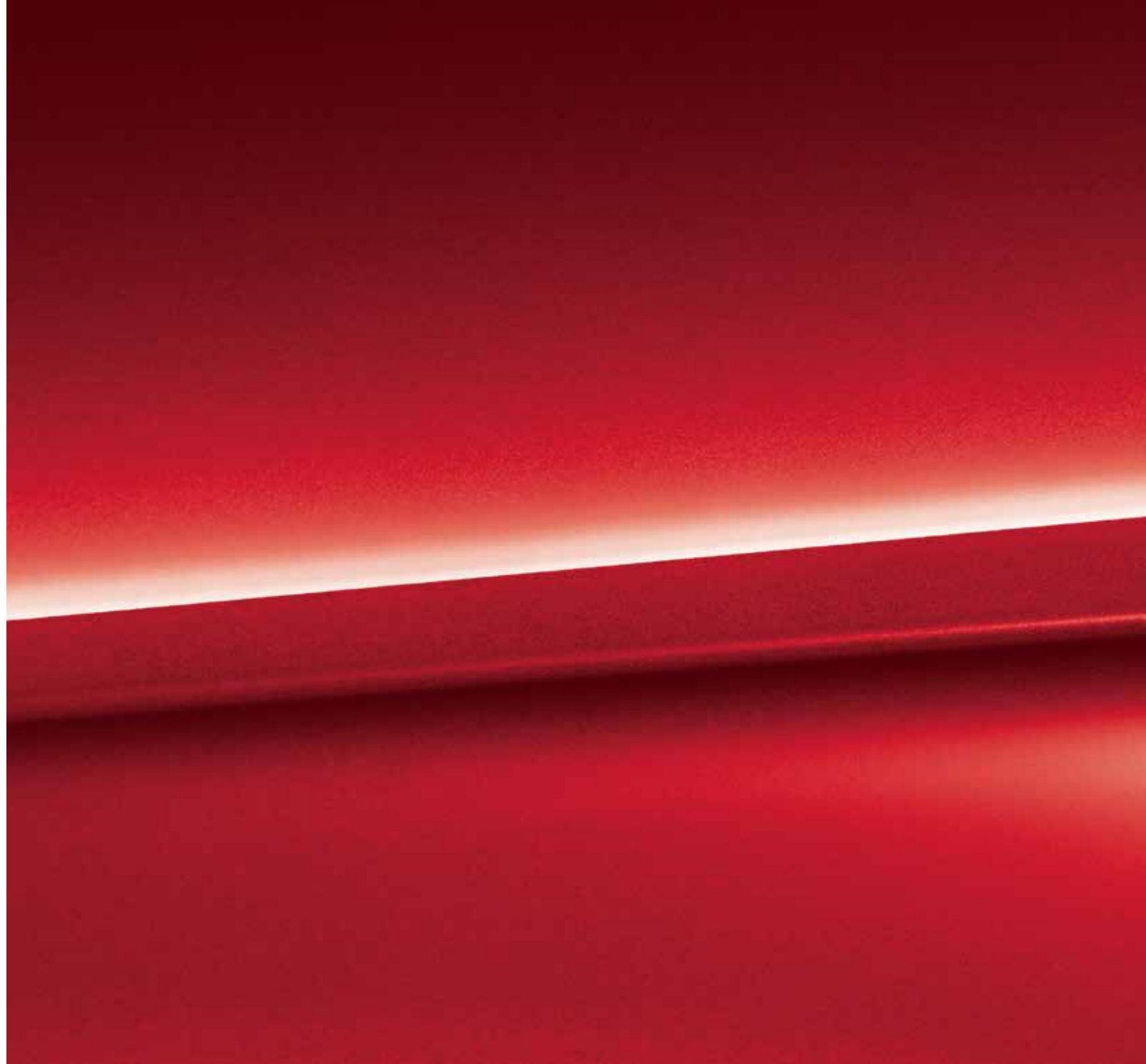

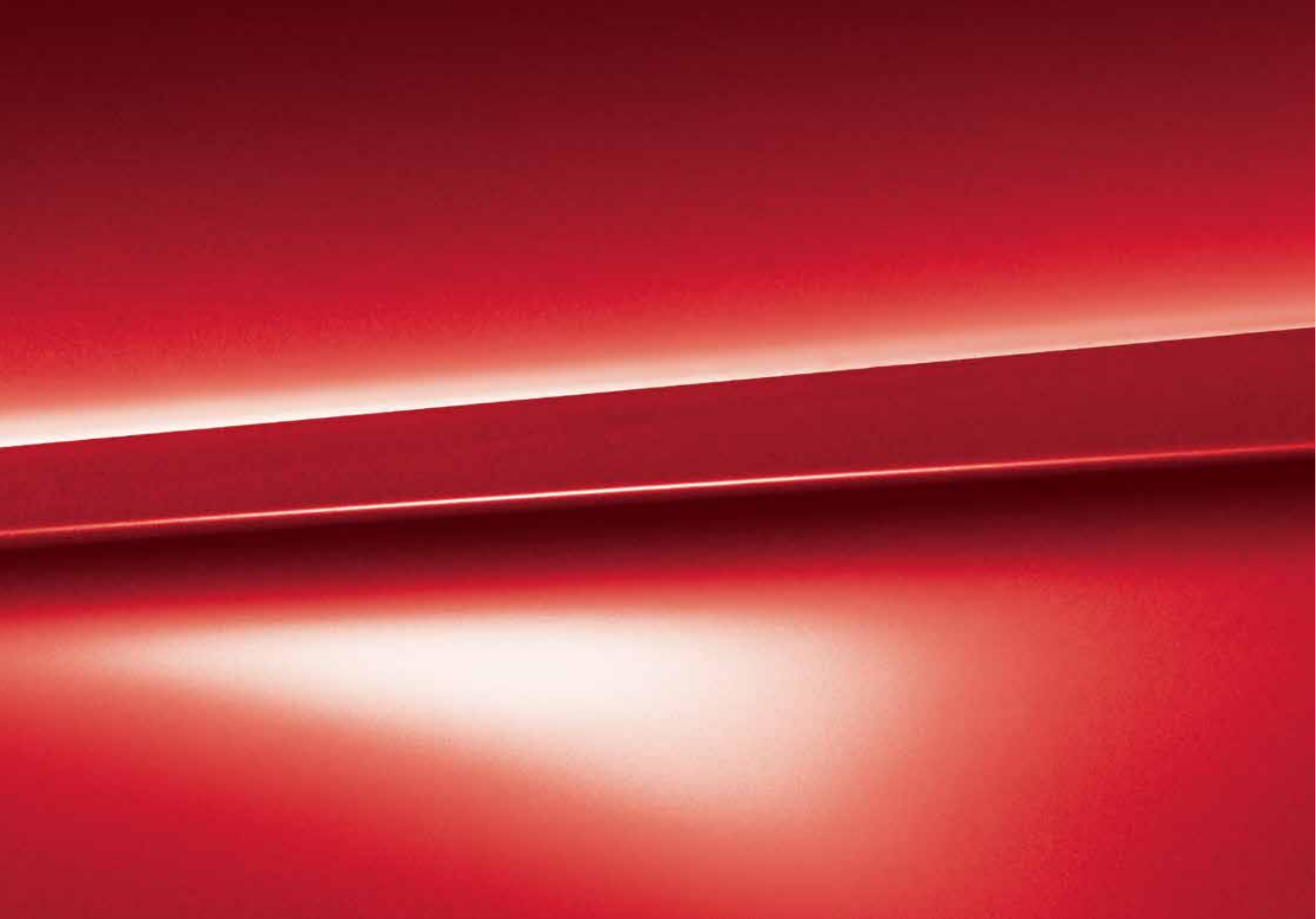



# Paint

You can select one of the standard colours shown opposite or, for a different look, choose from the range of metallic or pearl-effect finishes.

## Standard colours



Amalfi white - Y5

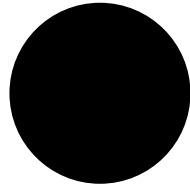

Brilliant black - A2

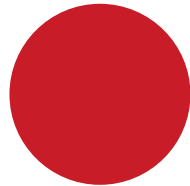

Brilliant red - C8

## Optional colours

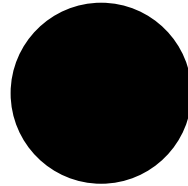

Phantom black, pearl effect - L8

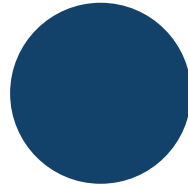

Scuba blue, metallic - S9



Glacier white, metallic - ZY

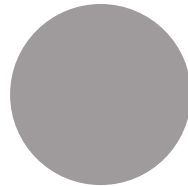

Lotus grey, metallic - Z2

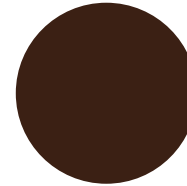

Beluga brown, metallic - M5

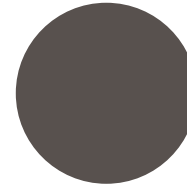

Dakota grey, metallic - Y7

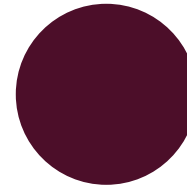

Shiraz red, metallic - 3A

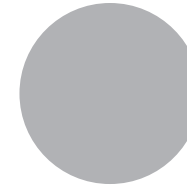

Ice silver, metallic - P5

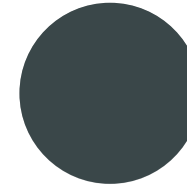

Monsoon grey, metallic - 0C

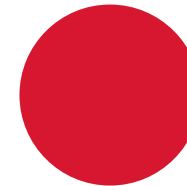

Misano red, pearl effect - N9

## S line colour

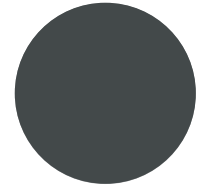

Daytona grey, pearl effect - 6Y

Options are subject to availability and may extend delivery.

All the colour swatches on this page are matched as accurately as possible to the actual paint colours used. However, due to print processes, Audi UK cannot guarantee that colours shown are 100% accurate.

Visit your local Audi Centre for a more accurate colour swatch.

RRP - Recommended Retail Price.

VAT is calculated at 20% but this may alter to reflect any change in the applicable VAT rate.

### Optional and S line colours

**Basic RRP**  
£437.50

**Total RRP inc VAT**  
£525.00

## Hood colours

The fully automated acoustic hood is available in the colours opposite, so you can complement your car's interior and exterior.

The automatic hood on SE models is available in black only, unless the optional fully automated hood (3FT) is chosen.

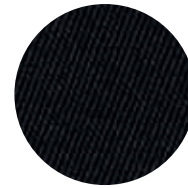

Black - PA

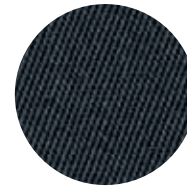

Grey - SW\*



Brown - PW\*



Options are subject to availability and may extend delivery.

All the hood colour swatches on this page are matched as accurately as possible to the actual hood colours used. However, due to print processes, Audi UK cannot guarantee that colours shown are 100% accurate.

Visit your local Audi Centre for a more accurate colour swatch.

\*Only available in combination with Fully automated acoustic hood (3FT).

## Upholstery

It's important to feel comfortable on the road. Just choose from our range of luxury upholstery materials and textures, including additional support and colour options, for complete relaxation while you drive.







# Upholstery

## A3 Cabriolet SE models

Choose your favourite upholstery from the swatches shown opposite to give your car's interior the look and feel you want.

	SE	Sport	S line	Basic RRP	Total RRP inc VAT
Marathon cloth					
	S	-	-	No charge	No charge
Milano leather					
	●	-	-	£929.17	£1,115.00

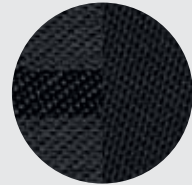

Black - FZ/JN

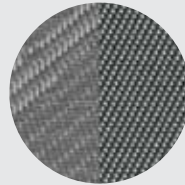

Titanium grey - VQ/JI

**Standard seats in Marathon cloth.** Seat centre sections in Marathon cloth. Side bolsters, head restraints as well as door and rear side panel inserts in plain cloth



Black - FZ/JN



Pashmina beige - JO

**Standard seats in Milano leather.** Seat centre sections and head restraints in Milano leather. The inner seat side bolsters, backrest side bolsters and upper shoulder sections are finished in velvet. The front centre armrest and door trim inserts are finished in synthetic leather. Must be ordered in conjunction with Storage and Luggage package (QE1)



Marathon cloth upholstery in black

Options are subject to availability and may extend delivery.

- = Not available
- = Available
- S = Standard

RRP - Recommended Retail Price.

VAT is calculated at 20% but this may alter to reflect any change in the applicable VAT rate.

# Upholstery

## A3 Cabriolet SE models

Options are subject to availability  
and may extend delivery.

- = Not available  
• = Available  
S = Standard

\*Image shown also includes optional  
Milano leather and under-seat storage  
which is part of the storage package,  
available at additional cost.

RRP - Recommended Retail Price.

VAT is calculated at 20% but this may alter to  
reflect any change in the applicable VAT rate.





Standard seat\* in Milano leather with Pashmina beige upholstery



# Upholstery

## A3 Cabriolet Sport models

Choose your favourite upholstery from the swatches shown opposite to give your car's interior the look and feel you want.

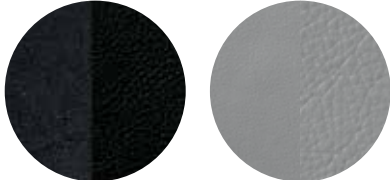
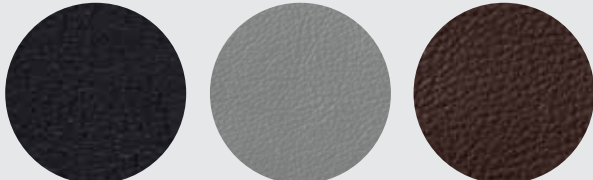
	SE	Sport	S line	Basic RRP	Total RRP inc VAT
<p><b>Rallye cloth</b></p>  <p>Black - FZ/JN      Black/silver - KY/ZR      Black/blue - LQ/KO</p>  <p>Black/yellow - RR/LI</p> <p><b>Sports seats in Rallye cloth.</b> Seat centre sections in Rallye cloth design. Seat side bolsters, head restraints as well as door and rear side panel inserts in plain cloth</p>	-	S	-	No charge	No charge
<p><b>Alcantara/leather</b></p>  <p>Black - FZ/JN      Titanium grey - VQ/JI</p> <p><b>Sports seats in Alcantara/leather.</b> Seat centre sections and door trim inserts in Alcantara. Head restraints, seat side bolsters and front centre armrest in leather. Only in combination with Storage and Luggage package (QE1)</p>	-	•	-	£662.50	£795.00
<p><b>Milano leather</b></p>  <p>Black - FZ/JN      Titanium grey - VQ/JI      Chestnut brown - VN/KI</p> <p><b>Sports seats in Milano leather.</b> Seat centre sections and head restraints in Milano leather. Seat side bolsters, upper shoulder sections, door trim inserts and front centre armrest are finished in velvet. Must be ordered in conjunction with Storage and Luggage package (QE1)</p>	-	•	-	£929.17	£1,115.00

Options are subject to availability and may extend delivery.

- = Not available  
• = Available  
S = Standard

RRP - Recommended Retail Price.

VAT is calculated at 20% but this may alter to reflect any change in the applicable VAT rate.

# Upholstery

## A3 Cabriolet Sport models

Options are subject to availability  
and may extend delivery.

- = Not available  
• = Available  
S = Standard

\*Image shown also includes optional  
electric lumbar support and under-seat  
storage which is part of the storage  
package, both of which are available at  
additional cost.

RRP - Recommended Retail Price.

VAT is calculated at 20% but this may alter to  
reflect any change in the applicable VAT rate.



Sports seat\* in Rallye cloth with black/silver upholstery

# Upholstery

## A3 Cabriolet Sport models

Lasso brown

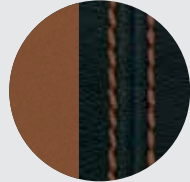

Lasso brown – BO/CO

**Lasso brown design package for Sports seats.** Front seat side bolsters, head restraints, front centre armrest, knee pads and armrest in the doors in black Milano leather with contrasting stitching in Lasso brown, upper shoulder sections and door trim inserts in Lasso brown velvet. Includes Lasso brown contrasting stitching on the leather steering wheel, gear lever and gaiter. Also includes floor mats with piping in Lasso brown. Must be ordered in conjunction with Storage and Luggage package (QE1)

SE	Sport	S line	Basic RRP	Total RRP inc VAT
–	●	–	£1,875.00	£2,250.00



Options are subject to availability and may extend delivery.

- = Not available
- = Available
- S = Standard

RRP – Recommended Retail Price.



VAT is calculated at 20% but this may alter to reflect any change in the applicable VAT rate.



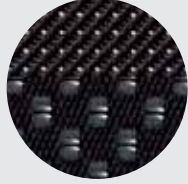

# Upholstery

## A3 Cabriolet S line models

	SE	Sport	S line	Basic RRP	Total RRP inc VAT
<p>Biathlon cloth/ Pearl Nappa leather</p>  <p>Black - QF</p> <p><b>Biathlon cloth/leather</b> with S line embossing on the front seats. Seat centre sections in Biathlon cloth. Door trim inserts, head restraints, seat side bolsters and front centre armrest in Pearl Nappa leather. Contrasting silver stitching on the upholstery, steering wheel and gear knob gaiter</p>	-	-	S	No charge	No charge
<p>Perforated Alcantara/leather</p>  <p>Black - QF</p> <p><b>Perforated Alcantara perforated/leather</b> with S line embossing on the front seats. Seat centre sections and door trim inserts in perforated Alcantara. Head restraints, seat side bolsters and front centre armrest in leather. Contrasting silver stitching on the upholstery, steering wheel and gear knob gaiter</p>	-	-	•	£400.00	£480.00
<p>Fine Nappa leather</p>  <p>Black - QF</p> <p><b>Fine Nappa leather</b> with S line embossing on the front seats. Seat centre sections, seat side bolsters, head restraints and front centre armrest in Fine Nappa leather. The upper shoulder sections and door trim inserts are finished in velvet. Contrasting silver stitching on the upholstery, steering wheel and gear knob gaiter</p>	-	-	•	£662.50	£795.00

Options are subject to availability and may extend delivery.

- = Not available  
• = Available  
S = Standard

RRP - Recommended Retail Price.

VAT is calculated at 20% but this may alter to reflect any change in the applicable VAT rate.



Super Sports seats in black Fine Nappa leather



# Colour and trim guide

## Interior trim colours

### SE models

To help you choose the right interior for your new Audi A3 Cabriolet, please use this guide, showing the carpet, dashboard and headlining colours that have been matched to your chosen upholstery.

### Sport models

### S line models

Options are subject to availability and may extend delivery.

- = Not available
- = Available
- S = Standard

Order Code	Upholstery	Carpet	Dashboard (upper/lower)	Headlining	Marathon cloth (N5G)	Milano leather (N5W)
FZ	Black	Black	Black/Black	Lunar silver	•	•
JN	Black	Black	Black/Black	Black	•	•
VQ	Titanium grey	Titanium grey	Black/Titanium grey	Lunar silver	•	—
JI	Titanium grey	Titanium grey	Black/Titanium grey	Black	•	—
JO	Pashmina beige	Velvet beige	Black/Pashmina beige	Black	—	•

Order Code	Upholstery	Carpet	Dashboard (upper/lower)	Headlining	Rallye cloth (N5B)	Alcantara/Nappa leather (N7U)	Milano leather (N5W)	Lasso brown design package (PEP)
FZ	Black	Black	Black/Black	Lunar silver	•	•	•	—
JN	Black	Black	Black/Black	Black	•	•	•	—
KY	Black/Silver	Black	Black/Black	Lunar silver	•	—	—	—
ZR	Black/Silver	Black	Black/Black	Black	•	—	—	—
LQ	Black/Blue	Black	Black/Black	Lunar silver	•	—	—	—
KO	Black/Blue	Black	Black/Black	Black	•	—	—	—
RR	Black/Yellow	Black	Black/Black	Lunar silver	•	—	—	—
LI	Black/Yellow	Black	Black/Black	Black	•	—	—	—
VQ	Titanium grey	Titanium grey	Black/Titanium grey	Lunar silver	—	•	•	—
JI	Titanium grey	Titanium grey	Black/Titanium grey	Black	—	•	•	—
VN	Chestnut brown	Black	Black/Black	Lunar silver	—	—	•	—
KI	Chestnut brown	Black	Black/Black	Black	—	—	•	—
BO	Lasso brown/Black	Black	Black/Black	Lunar silver	—	—	—	•
CO	Lasso brown/Black	Black	Black/Black	Black	—	—	—	•

Order Code	Upholstery	Carpet	Dashboard (upper/lower)	Headlining	Biathlon cloth (N7V)	Perforated Alcantara/leather (N7K)	Fine Nappa leather (N2R)
QF	Black	Black	Black/Black	Black	•	•	•



# Seats

Choose from a variety of different seat options so you can maintain the correct driving posture at all times.

Order Code		SE	Sport	S line	Basic RRP	Total RRP inc VAT
<b>7P1</b>	<b>Electric lumbar support.</b> For front seats with horizontal and vertical adjustment	●	●	●	£162.50	£195.00
<b>4A3</b>	<b>Heated front seats.</b> Individually controlled variable temperature adjustment for driver and front passenger seats	●	●	●	£216.67	£260.00
<b>PS6</b>	<b>Super Sports seats (front)</b> in black Fine Nappa leather with integrated head restraints, pronounced side bolsters for improved lateral support when cornering, manual seat adjustment including adjustment of the seat cushion angle with extendable thigh support and electric lumbar support	—	—	●	£1,325.00	£1,590.00

Options are subject to availability and may extend delivery.

- = Not available
- = Available
- S = Standard

RRP – Recommended Retail Price.

VAT is calculated at 20% but this may alter to reflect any change in the applicable VAT rate.

## Inlays

Attention to detail can make a big impact. From contemporary micrometallic silver to matt-brushed aluminium, our selection of inlays offers the perfect finishing touch to your car's interior.



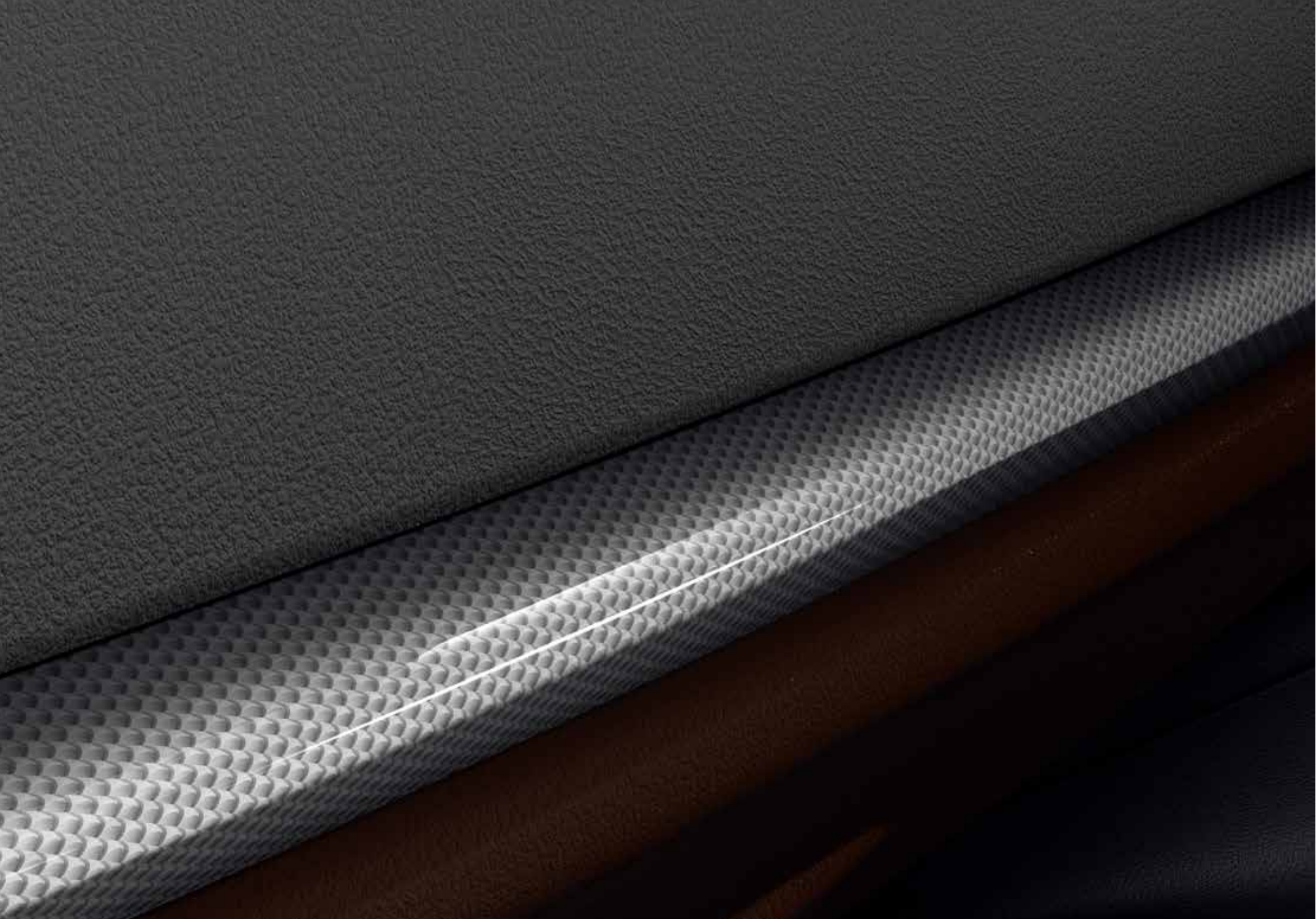

# Inlays

Inlays are the all-important finishing touch that add flair and interest to your car's interior.

Order Code		SE	Sport	S line	Basic RRP	Total RRP inc VAT
<b>5MA</b>	<b>Micrometallic silver</b>	S	-	-	No charge	No charge
<b>7TM</b>	<b>3D design 'optic'</b>	●	●	-	£125.00	£150.00
<b>5TD</b>	<b>Aluminium mistral silver</b> (Aluminium mistral bronze when interior colour Pashmina beige JO is ordered on SE trim)	●	S	-	£166.67	£200.00
<b>5TG</b>	<b>Matt-brushed aluminium</b>	-	-	S	No charge	No charge

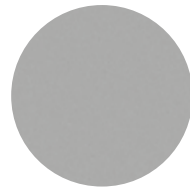

Micrometallic silver – **5MA**

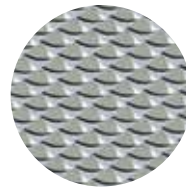

3D design 'optic' – **7TM**



Aluminium mistral silver – **5TD**

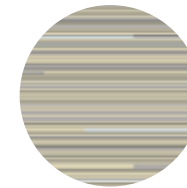

Aluminium mistral bronze – **5TD**

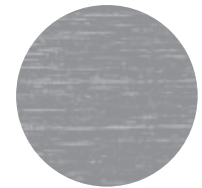

Matt-brushed aluminium – **5TG**

Options are subject to availability and may extend delivery.

- = Not available  
● = Available  
S = Standard

RRP – Recommended Retail Price.

VAT is calculated at 20% but this may alter to reflect any change in the applicable VAT rate.





## Options

Every driver has different needs, which is why we have created some useful options to further enhance your car. For extra comfort, support, style or function, you can choose from a variety of additional features, tailoring everything from your infotainment and audio equipment to your wheels and lighting.





## Wheels, tyres and suspension

Choose a set of specially selected alloy wheels to subtly enhance the way your car looks.



16" x 7J '10-spoke' design  
alloy wheels - CB8



17" x 7.5J '5-arm' design  
alloy wheels - CF7



17" x 7.5J '10-spoke Dynamic'  
design alloy wheels - CSI



17" x 7.5J '5-spoke' design  
alloy wheels - COX



18" x 8J 'multi-spoke Star' design  
part-polished alloy wheels - C1J



18" x 8J '5-parallel-spoke' design  
part-polished alloy wheels - C0J



18" x 8J '5-arm Structured' design  
high-gloss alloy wheels - CS1



19" x 8J '5-arm Wing' design high-gloss  
titanium alloy wheels - C7D



# Wheels, tyres and suspension

Order Code	SE	Sport	S line	Basic RRP	Total RRP inc VAT
<b>CB8</b> 16" x 7J '10-spoke' design alloy wheels with 205/55 R16 tyres	S	–	–	No charge	No charge
<b>CF7</b> 17" x 7.5J '5-arm' design alloy wheels with 225/45 R17 tyres	–	S	–	No charge	No charge
<b>C5I</b> 17" x 7.5J '10-spoke Dynamic' design alloy wheels with 225/45 R17 tyres	●	–	–	£412.50	£495.00
	–	●	–	£208.33	£250.00
<b>C0X</b> 17" x 7.5J '5-spoke' design alloy wheels with 225/45 R17 tyres	●	–	–	£412.50	£495.00
	–	●	–	£208.33	£250.00
<b>C1J</b> 18" x 8J 'multi-spoke Star' design part-polished alloy wheels with 225/40 R18 tyres	●	–	–	£995.83	£1,195.00
	–	●	–	£495.83	£595.00
<b>C0J</b> 18" x 8J '5-parallel-spoke' design part-polished alloy wheels with 225/40 R18 tyres	–	–	S	No charge	No charge
<b>CS1</b> 18" x 8J '5-arm Structured' design high-gloss alloy wheels with 225/40 R18 tyres	–	●	–	£829.17	£995.00
	–	–	●	£329.17	£395.00
<b>C7D</b> 19" x 8J '5-arm Wing' design high-gloss titanium alloy wheels with 235/35 R19 tyres. Not available in combination with S line Sports suspension	–	●	–	£1,245.83	£1,495.00
	–	–	●	£829.17	£995.00

Options are subject to availability and may extend delivery.

– = Not available  
● = Available  
S = Standard

RRP – Recommended Retail Price.

VAT is calculated at 20% but this may alter to reflect any change in the applicable VAT rate.



# Wheels, tyres and suspension

Order Code		SE	Sport	S line	Basic RRP	Total RRP inc VAT
<b>2H6</b>	<b>Audi drive select.</b> Changes vehicle characteristics by adapting power steering assistance, accelerator and the gear-shift characteristics of the S tronic transmission. The system also influences other optional equipment through five available modes: comfort, auto, dynamic, efficiency and individual. The efficiency mode adapts the engine characteristics, enables free-wheeling mode with the S tronic transmission and engages the climate control and the optional adaptive cruise control into an efficient fuel-saving setting	●	S	S	£183.33	£220.00
<b>2H7</b>	<b>Audi magnetic ride.</b> Continuously adapts the suspension damping to the changing driving situation. It does this automatically and in just a few fractions of a second by means of an electronically controlled magnetic field. This results in impressive handling dynamics accompanied by a remarkably high degree of ride comfort. The auto, comfort and sport modes allow the basic setting to be adjusted individually as desired. There is a pronounced difference between the respective basic set-ups. - Ample ride comfort thanks to low body acceleration and movements - Enhanced agility and handling dynamics thanks to reduced dynamic roll angles during steering inputs - Improved pitch characteristics when accelerating and slowing down - Clear distinction between the modes comfort (balanced and comfortable), sport (sporty and dynamic) and auto (adapted to prevailing driving situation) - Controlled wheel damping ensures remarkable handling stability and safety, especially when road conditions are poor - High long-distance suitability - Including Sports suspension: approximately 15mm lower than dynamic suspension, tauter suspension and damping settings - Convenient adjustment of suspension tuning using a button in the centre console	–	●	●	£829.17	£995.00
<b>1N7</b>	<b>Progressive steering</b> operates with a variable steering ratio which reduces the steering effort required e. g. in tight bends. This improves comfort on the one hand, for instance when parking or manoeuvring, and at the same time also provides a sportier driving feel e. g. when driving along narrow, winding roads. - High steering precision combined with minimised steering effort thanks to variable steering ratio - Precise steering feel with good feedback from the road - Incorporates all functions of the electromechanical power steering - Sporty, direct steering feel when driving straight ahead - Noticeable dynamic response and far less need to reposition hands in bends, on winding roads and when turning - More comfort as less steering effort required when parking or manoeuvring - Can be configured via Audi drive select	–	●	●	£245.83	£295.00
<b>2UA</b>	<b>Deselection of Sports suspension.</b> Available as a no-cost downgrade from Sports suspension on Sport and S line models. If selected then the Sports suspension lowering is removed and the suspension is returned to the standard ride height and damping	–	●	●	No charge	No charge
<b>2UC</b>	<b>Sports suspension.</b> Lowered by 15mm with stiffer suspension and damping for more direct contact with the road and sporty handling	–	S	S	No charge	No charge
<b>2UG</b>	<b>S line Sports suspension.</b> More dynamic spring/damper setting and lowered by an additional 10mm compared with the Sports suspension or by 25mm compared with the standard suspension	–	–	●	No charge	No charge

Options are subject to availability and may extend delivery.

– = Not available

● = Available

S = Standard

RRP – Recommended Retail Price.

VAT is calculated at 20% but this may alter to reflect any change in the applicable VAT rate.



# Packages

Some items work well together, which is why we've created these special packages. They provide increased convenience and value by combining several of our most popular options.

Options are subject to availability and may extend delivery.

- = Not available
- = Available
- S = Standard

RRP – Recommended Retail Price.

VAT is calculated at 20% but this may alter to reflect any change in the applicable VAT rate.

Order Code		SE	Sport	S line	Basic RRP	Total RRP inc VAT
<b>WBI 7X1 8T2</b>	<b>Comfort package.</b> Includes wind deflector (7S1), auto-dimming rear-view mirror (PU7), Audi parking system, rear (7X1) and Cruise control (8T2)	•	•	•	£575.00	£690.00
	In combination with Xenon light package	•	•	–	£250.00	£300.00
<b>WB6</b>	<b>Xenon light package.</b> Includes Adaptive headlights with Xenon Plus headlights (PXA) and Interior lighting package (QQ4)	•	•	–	£916.67	£1,100.00
<b>PG1</b>	<b>LED light package.</b> Includes LED headlights (PX7) and Interior lighting package (QQ4)	•	•	–	£1,541.67	£1,850.00
<b>PNQ</b>	<b>Technology package.</b> Includes HDD-based MMI Satellite Navigation Plus and MMI Touch with navigation data (flash memory), electrically extending, high-resolution 7-inch colour display with 800 x 480 pixel resolution, high-quality representation of the navigation map as 3D ground model with topographical map colouring, display of many sites and city models in 3D, choice of 3 alternative routes provided, split-screen mode for route information (manoeuvring points, points of interest on motorways, TMCpro on route), detailed junction map and lane recommendations, dynamic route guidance (where available), additional arrow display in the Driver's Information System; includes radio with triple tuner and phase diversity, flash memory for music (10GB), MP3, WMA, AAC and MPEG4-capable DVD player which can also be used for music and video DVDs, 2 SDXC card readers (for up to 2TB). MMI Touch: a touch-sensitive panel on the rotary/push-button control for intuitive operation of the MMI without taking your eyes off the road; context-related entry of letters and numbers for navigation destination via handwriting recognition with acoustic acknowledgement, selection from address book, entry of telephone numbers or search for media files; simple movement of navigation map and selection of points of interest	•	•	•	£833.33	£1,000.00*



MMI Touch (part of Technology package)



MMI Touch (part of Technology package)



Xenon headlight (part of Xenon light package)



# Packages

Options are subject to availability and may extend delivery.

<sup>1</sup>A3 Cabriolet will receive the upgraded 4G/LTE data connection capability. If a SIM card without a 4G data plan is used, then a 3G data connection will be used instead. The 3G signal can be used when a 4G signal is not available at the car's current location.

<sup>2</sup>Online services are only available for mobile phone contracts or SIM cards which include a data option and only within the coverage of the mobile phone network; there may be additional costs for the use of these services (charges and billing correspond to the personal mobile phone contract or SIM card contract). Due to high data volumes, a mobile phone contract including an unlimited or high usage data plan is strongly recommended. The content and scope of the online based services offered may vary.

- = Not available  
• = Available  
S = Standard

RRP – Recommended Retail Price.

VAT is calculated at 20% but this may alter to reflect any change in the applicable VAT rate.

Order Code	SE	Sport	S line	Basic RRP	Total RRP inc VAT
<b>WB4</b>	•	-	-	£1,183.33	£1,420.00*
	-	•	•	£1,083.33	£1,300.00*

**Technology package with Mobile telephone preparation - High with Audi connect.** Includes Technology package (PNQ). Audi connect provides access to a number of innovative online services via an internal UMTS (4G)<sup>1</sup> module. Audi connect online services include: navigation using Google Earth images and Google Street View, destination entry via Google Maps or myAudi, online point of interest search and information services such as weather forecasts and the latest world news. Audi connect also includes Audi traffic information online, which gives accurate real-time forecasts of the traffic situation along the chosen route. The traffic situation can be displayed on the navigation map or Google Earth image. Audi connect can also create a Wi-Fi hotspot in the car for convenient internet access using a mobile device (e.g. laptop or tablet). Many Audi connect features can be simply operated via MMI Navigation Plus or the multi-function steering wheel

**Important connectivity information:** An external data source is required to enable the Audi connect online services<sup>2</sup>. A separate SIM card which can be inserted in the included SIM card reader. When a separate SIM card is used, hands-free phone calls are possible using the SIM card or by connecting a different mobile telephone via Bluetooth Hands-Free Profile



Audi connect

\*Technology package with Mobile telephone preparation - High with Audi connect is available for £1,420 only on new A3 Cabriolet SE and £1,300 only on new A3 Cabriolet Sport and S line pre-orders until 7 March 2014.

# Audio and communication

Stay in touch using our range of communication functions, and give each journey its own soundtrack with our advanced audio equipment.

Options are subject to availability and may extend delivery.

- = Not available  
• = Available  
S = Standard

RRP – Recommended Retail Price.

VAT is calculated at 20% but this may alter to reflect any change in the applicable VAT rate.

Order Code		SE	Sport	S line	Basic RRP	Total RRP inc VAT
956	<b>Colour Driver's Information System (DIS)</b> with high-resolution 3.5" TFT colour display. Also available as part of Technology package with Mobile telephone preparation – High with Audi connect (WB4)	•	S	S	£100.00	£120.00
9VD	<b>Audi sound system.</b> 9 speakers in total including centre speaker in the dashboard. 6-channel amplifier with a total output of 140 watts	•	•	•	£212.50	£255.00
9VS	<b>Bang &amp; Olufsen sound system.</b> Surround sound reproduction via 13 high-performance speakers including centre speaker in the dashboard and two kick-bass speakers each delivering 100 watts and 13-channel amplifier with a total output of 625 watts. Exclusive speaker covers with aluminium applications and LED lighting accentuating the front woofers. The sound is permanently adapted to compensate for driving and background noises determined by a microphone. 5.1 surround sound reproduction is possible when ordered in conjunction with Technology package or Technology package with Mobile telephone preparation - High with Audi connect	•	•	•	£625.00	£750.00
9ZE	<b>Audi Phone Box</b> allows phone calls to be made without a mobile phone cradle. The mobile phone is simply placed in the purpose-designed compartment in the front centre console, which blends smoothly into the overall interior design. Includes: - A hands-free facility for the phone functions via multi-function steering wheel - Low SAR radiation in the vehicle interior and improved reception quality: wireless connection to the car aerial at automatically reduced field strength by means of an integrated coupling aerial in the storage compartment - Can be charged from USB socket - Operated via the radio/navigation systems or the multi-function steering wheel - The mobile phone is automatically recognised after it has been connected for the first time	•	•	•	£270.83	£325.00
PNU	<b>Satellite Navigation system – SD card-based.</b> Route planning and guidance using voice, pictogram and 2D mapping shown on the 5.8" colour display screen. Can be operated via the MMI controls or the multi-function steering wheel. Includes European map data and 7-digit postcode recognition	•	•	•	No charge	No charge*



Bang & Olufsen sound system



Audi Phone Box



# Interior equipment

Specify every detail of your car's interior with this range of exclusive options.

Order Code		SE	Sport	S line	Basic RRP	Total RRP inc VAT
QQ5	<b>Illuminated vanity mirrors.</b> In the driver and passenger sun visor	●	●	S	£45.83	£55.00
QQ4	<b>Interior lighting package.</b> Anti-glare lighting for the passenger compartment comprising door sill and footwell lighting at the front as well as illuminated inside door openers, vanity mirrors and illuminated cup holders, two reading lights each at the front and rear, LED interior ambient lighting and active door reflectors. Also available as part of the Xenon light package (WB6) or the LED light package (PG1)	●	●	—	£187.50	£225.00
		—	—	●	£141.67	£170.00
9K1	<b>Head-level heating, front.</b> Airflow directed specifically towards the head area for driver and front passenger via air vents on the front seat backrests to minimise the impact of wind and temperature with the hood open. There are three different settings which can be adjusted via the MMI. Only in combination with Heated front seats (4A3)	—	●	●	£291.67	£350.00
9AK	<b>Dual-zone electronic climate control.</b> Separate control for the driver and front passenger which electronically regulates the air temperature, air flow rate and air distribution. Automatic recirculation mode using an air quality sensor, combined filter, rear vents and humidity regulation for more efficient climate control	●	S	S	£325.00	£390.00
4F2	<b>Advanced key.</b> Access and authorisation system which automatically exchanges data between key and vehicle, allowing the driver to keep the key in their pocket or bag at all times. To unlock and open, simply lift the exterior door handle. To lock, press the button on the handle. Also includes an ignition start and stop button integrated in the centre console	●	●	●	£354.17	£425.00
PU7	<b>Auto-dimming rear-view mirror.</b> Includes a light sensor which detects when the headlights behind are too bright and dims the rear-view mirror automatically. Also available as part of the Comfort package (WBI)	●	●	●	£204.17	£245.00

Options are subject to availability and may extend delivery.

- = Not available
- = Available
- S = Standard

RRP – Recommended Retail Price.

VAT is calculated at 20% but this may alter to reflect any change in the applicable VAT rate.



# Interior equipment

Order Code		SE	Sport	S line	Basic RRP	Total RRP inc VAT
3X2	<b>Ski/snowboard bag.</b> For the practical and safe transportation of long objects, up to four pairs of skis or two snowboards	●	●	●	£62.50	£75.00
QE1	<b>Storage and luggage package.</b> Includes storage nets on the back of the front-seat backrests, storage compartment under the front driver's seat, storage net in the front-passenger footwell, storage compartment under the rear bench (including two high-visibility vests), 12V socket in the rear centre console; in the luggage compartment: LED luggage compartment light, net at the side, luggage compartment net, 12V socket	●	●	S	£120.83	£145.00
7HE	<b>Extended mono.pur interior finish.</b> Front knee pads and armrests finished in mono.pur leather-effect material. Also includes stitching in the colour of the seat upholstery	●	●	●	£245.83	£295.00
QJ1	<b>Aluminium interior elements.</b> On the vents, glove compartment, wing-mirror adjustment switches, electric window switches, frame around the inside door handle, control buttons for the parking brake and the hold-assist button (if fitted)	●	S	S	£62.50	£75.00
9JA	<b>Non-smoking package.</b> Removes the ashtray and replaces the cigarette lighter with a standard 12V socket	●	●	●	No charge	No charge

Options are subject to availability and may extend delivery.

- = Not available
- = Available
- S = Standard

RRP – Recommended Retail Price.

VAT is calculated at 20% but this may alter to reflect any change in the applicable VAT rate.

# Exterior equipment

Make sure your car looks exactly as you want it to by selecting some of our striking options.

Options are subject to availability and may extend delivery.

- = Not available
- = Available
- S = Standard

RRP – Recommended Retail Price.

VAT is calculated at 20% but this may alter to reflect any change in the applicable VAT rate.

Order Code	SE	Sport	S line	Basic RRP	Total RRP inc VAT
<b>PXA</b> <b>Adaptive headlights with Xenon Plus headlights.</b> The dynamic cornering light identifies the course of the road from the movement of the steering wheel. The headlights swivel into the corner – depending on the steering angle – to provide variable illumination of the curve; navigation or speed-dependent distribution of light from headlights for town, junction, country and motorway, in a speed range from approximately 6 to 68mph	-	-	•	£245.83	£295.00
<b>8G1</b> <b>High-beam assist.</b> Working within system limits, automatically detects the headlights of oncoming traffic, the rear lights of other road users and built-up areas and depending on the traffic situation, the high beam is automatically switched on or off. Also available as part of Audi active lane assist (PCB) and Driver assistance package (PCE). Only in combination with Auto-dimming rear-view mirror (PU7) or Comfort package (WBI). Not available in combination with Xenon light package or Adaptive headlights with Xenon Plus headlights	•	•	•	£83.33	£100.00
<b>8G2</b> <b>Variable headlight range control.</b> Upgrades the functionality of the Adaptive lights with the aid of a camera which detects other road users or light sources and allows infinitely variable adaptation of the headlight range between main and dipped beam. Only in combination with either Audi active lane assist (PCB) or Audi active lane assist and Audi side assist (7Y5) or driver assistance package (PCE), plus either Adaptive headlights with Xenon Plus headlights (PXA) or Xenon light package (WB6), plus either Auto-dimming rear-view mirror with light and rain sensor package (PU7) or Comfort package (WBI)	•	•	•	£145.83	£175.00
	In combination with Audi active lane assist or Driver assistance package			•	•
<b>2Z0</b> <b>Deletion of model and technology designation at rear</b>	•	•	•	No charge	No charge
<b>2Z7</b> <b>Deletion of technology designation at rear</b>	•	•	•	No charge	No charge

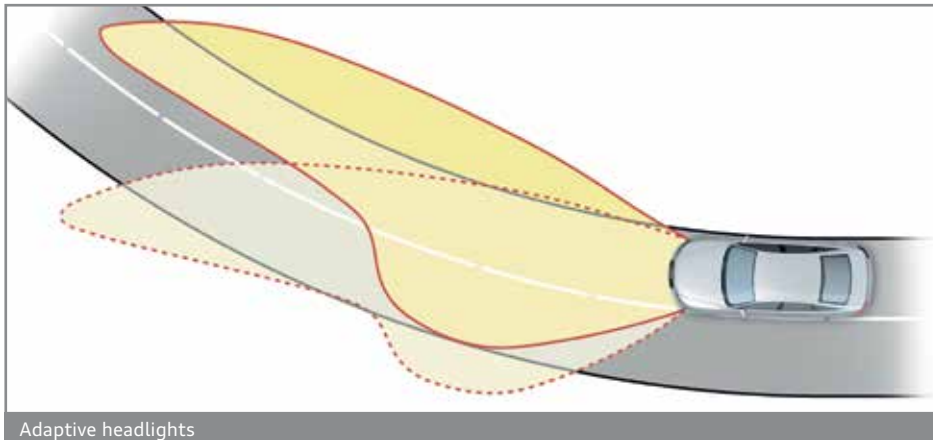

Adaptive headlights



Xenon Plus headlights

# Exterior equipment

Order Code	SE	Sport	S line	Basic RRP	Total RRP inc VAT
<p><b>PX7</b></p> <p><b>LED headlights.</b> Combining their unmistakable looks, a long service life and excellent efficiency. LED headlights offer dipped beam, high beam and the combined function of daytime-running lights, sidelights and indicators. The stunning Audi light graphics give the headlights a striking appearance.</p> <ul style="list-style-type: none"> <li>- Including LED rear lights and headlight cleaning system</li> <li>- Light conductor is fed by yellow and white LEDs for a distinctive look</li> <li>- Turning lights provide more lateral illumination on tight bends and when turning</li> <li>- The headlight distribution modes for motorway light and country road light are activated depending on the road speed</li> <li>- Motorway light with extended range at speeds above approximately 68mph</li> <li>- All-weather light makes conventional front fog lights superfluous and reduces glare in poor visibility (in fog, rain or snow)</li> <li>- In conjunction with Technology package with Mobile telephone preparation - High with Audi connect (WB4) the navigation data works with the LED headlights to control the light distribution with motorway light and country light modes using the stored route data from MMI Navigation plus with MMI Touch;</li> <li>- Junction light, which provides a wide front light setting, as well as travel mode, which switches between right and left-hand drive modes assisted by GPS data</li> </ul>	-	-	●	£537.50	£645.00

Options are subject to availability and may extend delivery.

- = Not available
- = Available
- S = Standard

RRP – Recommended Retail Price.

VAT is calculated at 20% but this may alter to reflect any change in the applicable VAT rate.



LED headlight – daytime-running lights



LED headlight – dipped beam



LED headlight – indicator

# Exterior equipment

Order Code		SE	Sport	S line	Basic RRP	Total RRP inc VAT
<b>3FT</b>	<p><b>Fully automatic acoustic hood.</b> Combines cutting-edge technology with classic looks and works fully automatically. The hood seams run in the direction of travel, reinforcing the car's dynamic appearance.</p> <ul style="list-style-type: none"> <li>- Fully automatic acoustic hood made out of insulated, three layered fabric</li> <li>- Opens in just 17 seconds and closes in 18 – up to a road speed of 31mph</li> <li>- Compared with the conventional hood, optimised material thickness and mounting coupled with additional insulation substantially reduce the level of noise in the interior when the hood is closed</li> <li>- Can be ordered in black, grey and brown. Hood lining colour-coordinated with the interior in black or lunar silver</li> </ul>	●	S	S	£183.33	£220.00
<b>7S1</b>	<p><b>Wind deflector.</b> To reduce draughts and wind noise. Manually attached to mounting in rear seating area. Can be folded for compact stowage. Also available as part of the Comfort package (WBI)</p>	●	●	●	£241.67	£290.00
<b>6XE</b>	<p><b>Door mirrors –</b> electrically adjustable, folding and heated. Also includes an automatic kerb view dipping function on the passenger side when reverse gear is selected</p>	●	●	●	£125.00	£150.00
<b>6XK</b>	<p><b>Door mirrors –</b> auto-dimming on the driver's side, electrically adjustable, folding and heated. Also includes an automatic kerb view dipping function on the passenger side when reverse gear is selected. Only in combination with auto-dimming rear-view mirror (PU7) or Comfort package (WBI)</p>	●	●	●	£208.33	£250.00
<b>1D2</b>	<p><b>Towing equipment.</b> Removable and lockable. Sphere bar and ball head made of forged steel. The 13-pin socket can be swivelled out of sight behind the bumper skirt. When removed, the trailer towing hitch can be stored in the spare wheel well</p>	●	●	●	£520.83	£625.00

Options are subject to availability and may extend delivery.

– = Not available  
● = Available  
S = Standard

RRP – Recommended Retail Price.

VAT is calculated at 20% but this may alter to reflect any change in the applicable VAT rate.





Wind deflector

# Safety and security

Intelligent technology designed to give you better all-round awareness and safety on the road.

Options are subject to availability and may extend delivery.

- = Not available
- = Available
- S = Standard

RRP - Recommended Retail Price.

VAT is calculated at 20% but this may alter to reflect any change in the applicable VAT rate.

Order Code		SE	Sport	S line	Basic RRP	Total RRP inc VAT
UH2	<b>Hold assist.</b> Holds the vehicle stationary for unlimited periods after stopping and prevents the vehicle rolling on hills and on gradients. The system is activated by push-button and allows the driver to drive away easily and comfortably without having to operate the electromechanical parking brake	•	•	•	£75.00	£90.00
7X1	<b>Audi parking system, rear.</b> Makes reverse parking easier by indicating acoustically how far away the vehicle is from an object detected behind it. Measurement is by ultrasonic sensors integrated discreetly in the bumper. Also available as part of the Comfort package	•	•	•	£287.50	£345.00
7X2	<b>Audi parking system plus, front and rear with selective display.</b> Acoustic and visual parking aid for the front and rear which displays white distance markers for obstacles that would not be touched and red symbols for obstacles that may be touched. This provides the driver with a selective optical view in the MMI display of all the objects recognised, depending on the current curve radius and direction of travel. Measurement is by ultrasonic sensors discreetly integrated in the bumpers	•	•	•	£495.83	£595.00
	In combination with Comfort package	•	•	•	£208.33	£250.00
7X5	<b>Audi parking system plus, with park assist.</b> In addition to parking system plus front and rear, ultrasonic sensors are used to search for parking spaces by the roadside and the system calculates the ideal parking path for reverse and parallel parking spaces. The steering action is performed almost automatically. Assisted parking is now even possible in smaller parking spaces and bend areas, and the system will park the car in several moves if required. Steering is done by the vehicle, while the driver only needs to accelerate and apply the brakes. Four additional sensors indicate obstacles detected all around and at the side of the vehicle, and warn the driver, making parking easier and safer by setting the correct steering angle	•	•	•	£695.83	£835.00
	In combination with Comfort package	•	•	•	£408.33	£490.00
	In combination with Driver assistance package	•	•	•	£200.00	£240.00
KA2	<b>Reversing camera.</b> Gives a camera image of area behind the vehicle shown on the MMI display, with dynamic display modes highlighting the calculated path (steer-angle dependent). Includes auxiliary lines and guidelines, and identification of the point at which to apply opposite lock when parallel parking. The rear-view camera is integrated discreetly in the handle strip of the luggage compartment lid. Only in combination with Audi parking system plus, front and rear with selective display (7X2), Audi parking system plus, with park assist (7X5) or Driver assistance package (PCE)	•	•	•	£229.17	£275.00





# Safety and security

Order Code		SE	Sport	S line	Basic RRP	Total RRP inc VAT
8T2	<b>Cruise control.</b> Maintains any speed above 18mph, provided that the engine power output and engine braking effect permit it. Operated via separate steering column stalk, with set speed displayed in the Driver's Information System (DIS). Also available as part of the Comfort package	●	●	●	£187.50	£225.00
PCG	<b>Adaptive cruise control.</b> Automatic distance control (control range for manual transmission between 19-93mph and for S tronic 0-93mph. In conjunction with the optional Driver assistance package (PCE) the control range is extended up to 124mph). Also includes Stop/Go function only with S tronic. Working within system limits it uses a radar sensor to detect vehicles ahead and maintain this distance by automatically braking and accelerating. Four distance levels and different driving modes can be selected individually. Also includes Audi pre-sense front which provides an enhanced brake assist if it detects an imminent threat of collision with the vehicle in front. Braking action is initiated at speeds below 19mph if there is a danger of collision with a stationary or moving vehicle, to avoid or reduce impact	●	●	●	£479.17	£575.00
	In combination with Comfort package	●	●	●	£291.67	£350.00
7W1	<b>Audi pre-sense basic.</b> Networks the different vehicle systems to enable driving situations to be categorised and, where necessary, actions to be taken to protect the driver and passengers. These include: tensioning the front seat belts as well as closing the windows	●	●	●	£166.67	£200.00
7K1	<b>Tyre pressure monitoring.</b> Visual and acoustic warning if the pressure drops in one or more tyres	●	●	●	£62.50	£75.00

Options are subject to availability and may extend delivery.

- = Not available
- = Available
- S = Standard

RRP – Recommended Retail Price.

VAT is calculated at 20% but this may alter to reflect any change in the applicable VAT rate.



# Safety and security

Order Code		SE	Sport	S line	Basic RRP	Total RRP inc VAT
PCB	<b>Audi active lane assist.</b> Lane markings are registered by an optical sensor in the windscreen above speeds of approximately 40mph. Camera identifies individual or coloured lane markings, e.g. yellow lines at roadworks. The lane departure warning system warns the driver if a detected lane marking is approached without indicating, and helps the driver to steer back towards the middle of the lane by making gentle steering movements. Steering wheel vibration can be activated as an additional warning when crossing lane markings. System is activated manually by a switch on the turn signal lever. Also includes High-beam assist (8G1). When ordered with Technology package, speed limit display is included as a no-cost option. Also available as part of the Driver assistance package (PCE)	●	●	●	£375.00	£450.00
7Y1	<b>Audi side assist.</b> Aids the driver when changing lane. Audi side assist monitors the area behind your car using radar sensors located discreetly in the rear bumper. It then informs the driver with a visual warning signal in the door mirror if there is a vehicle in their blind spot or approaching quickly from behind. The system is activated using the MMI car settings	●	●	●	£375.00	£450.00
PCB 7Y5	<b>Audi active lane assist and Audi side assist.</b> Includes Audi Active lane assist (PCB) and Audi side assist (7Y1)	●	●	●	£750.00	£900.00
PCE	<b>Driver assistance package.</b> Contains all of the following assistance functions: Adaptive cruise control (with control range extended to 124mph), Audi active lane assist (PCB), High-beam assist (8G1) and Audi parking system plus front and rear (7X2). Not available in combination with Comfort package (WBI)	●	●	●	£1,083.33	£1,300.00
-	<b>Speed limit display.</b> Camera-based detection and display of speed limits, including temporary speed limits. Speed limit signs are recognised by the camera and this enables the current speed limit to be read conveniently in the Driver's Information System (DIS). Should the camera not detect a sign, the speed limit from the navigation system data (if fitted) will be shown. Only available as a no-cost option when Technology package (PNQ) and Audi active lane assist (PCB) are ordered together	●	●	●	No charge	No charge

Options are subject to availability and may extend delivery.

- = Not available  
● = Available  
S = Standard

RRP – Recommended Retail Price.

VAT is calculated at 20% but this may alter to reflect any change in the applicable VAT rate.

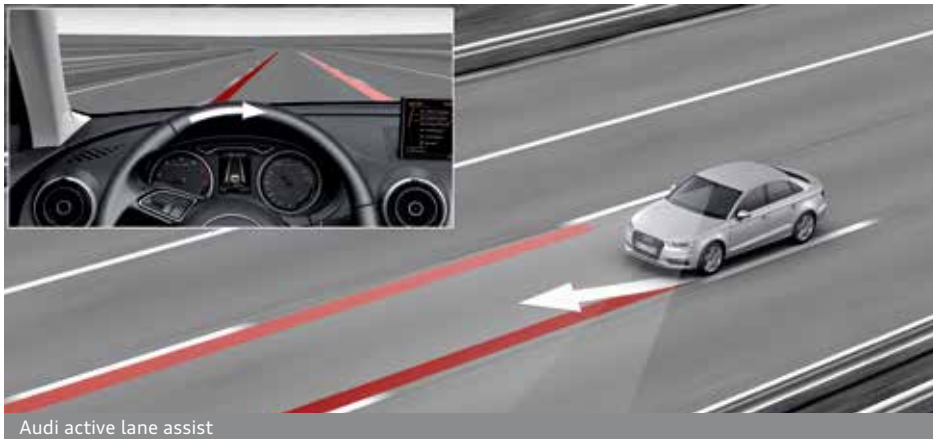

Audi active lane assist



Audi side assist

## Looking after your Audi

When you've chosen your ideal model, it's reassuring to know that it will remain in safe hands. That's why we've created products to protect your Audi, from extended warranties to the Audi Service Plan. And there's also a range of Audi accessories and merchandise to choose from, enabling you to further enhance and safeguard your car.





# Audi Complete

Audi Complete is simply a way to look after the servicing and maintenance costs for your Audi in a single package. You pay a one-off or monthly fee and we'll cover all your servicing, maintenance and tyres for the next three years, including your first MOT. It means you only have to pay for fuel, insurance and your Road Fund Licence. So you can be reassured that your car will be maintained by trained Audi Technicians, using genuine Audi parts. You can also opt for our Service only or Service and Maintenance packages if you prefer.

\*Retail customers only. Pricing based on 3 years/30,000 miles (whichever occurs sooner). All pricing is a 'starting from' price for the Audi A3 Cabriolet model range and is therefore subject to change and mileage/model dependent. If you drive under 10,000 miles per annum your vehicle will be placed on a fixed inspection service schedule. If your mileage tends to exceed 10,000 miles per annum it will be placed on the LongLife (Flexible) Service schedule.

## Service Plan

Choosing an Audi Service Plan provides an easy way to cover all your car's scheduled servicing costs with a one-off payment. It can take care of everything from fluid and filter changes to your full service, ensuring you retain a full Audi service history. There are no standard servicing bills to plan for and you'll continue to benefit from today's prices for the length of your agreement.

Offer may be withdrawn at any time.

Order Code		A3 Cabriolet	Basic RRP	Total RRP inc VAT
-	<b>Audi Complete – Service and Maintenance.</b> Comprehensive care for your Audi covering all your servicing and maintenance for 3 years, as well as your first MOT. Visit your local Audi Centre for further information or go to <a href="http://audi.co.uk/audicomplete">audi.co.uk/audicomplete</a> for full details including terms and conditions	Monthly Direct Debit	£16.67	£20.00*
-	<b>Audi Complete – Service, Maintenance and Tyres.</b> Comprehensive care for your Audi covering all your servicing, maintenance and tyres for 3 years, as well as your first MOT. Visit your local Audi Centre for further information or go to <a href="http://audi.co.uk/audicomplete">audi.co.uk/audicomplete</a> for full details including terms and conditions	Monthly Direct Debit	£25.00	£30.00*

		A3 Cabriolet	Basic RRP	Total RRP inc VAT
	<b>Audi Service Plan.</b> Comprehensive package covering servicing costs for 3 years or 30,000 miles, whichever comes sooner. Applicable to vehicles on either LongLife or Fixed Inspection Service Schedule. For retail customers only. Terms and conditions apply. Administered by Audi Finance, Freepost Audi Finance. Visit <a href="http://audi.co.uk">audi.co.uk</a> or your local Audi Centre for full details, including terms, conditions and exclusions	●	£332.50	£399.00

Audi Complete is also available to cover servicing, maintenance and tyres over a variable term and mileage. Visit [audi.co.uk](http://audi.co.uk) or your local Audi Centre for further details of this all-encompassing package.



# Warranty

All new Audi models now come with a choice of a three, four or five-year warranty.\* What's more, if you decide to sell your Audi before the warranty expires, it will be fully transferred to the new owner. So, whichever length of warranty you choose, you can forget about unexpected repair bills and enjoy several years of carefree driving.

Options are subject to availability and may extend delivery.

- = Not available
- = Available
- S = Standard

\*Three year warranty consists of a two-year unlimited mileage warranty and a third year warranty with a 60,000 mile limitation. Four year warranty consists of two-years' unlimited mileage coverage, and two further years' coverage with a 75,000 mile limitation. Five year warranty consists of two-years' unlimited mileage coverage, and three further years' coverage with a 90,000 mile limitation.

\*\*Only available prior to registration of your Audi A3 Cabriolet. Please speak to your Audi Centre for full details.

RRP – Recommended Retail Price.

VAT is calculated at 20% but this may alter to reflect any change in the applicable VAT rate.

Order Code		A3 Cabriolet	Basic RRP	Total RRP inc VAT
-	<b>Audi Warranty</b> , covering you for unlimited mileage in the first two years of ownership, and up to 60,000 miles in the third year. Transferable between owners**	S	No charge	No charge
EA6	<b>Audi Warranty</b> , covering you for up to 4 years or 75,000 miles, whichever comes sooner. Cover includes a two-year unlimited mileage warranty, and up to 75,000 miles in the third and fourth years. Transferable between owners**	•	£204.17	£245.00
EA9	<b>Audi Warranty</b> , covering you for up to 5 years or 90,000 miles, whichever comes sooner. Cover includes a two-year unlimited mileage warranty, and up to 90,000 miles in the third, fourth and fifth years. Transferable between owners**	•	£454.17	£545.00

## Accessories

Choosing an Audi isn't just a matter of deciding on the model you want; it's about creating a car that suits your needs perfectly. And that's why we've developed a whole range of accessories to enhance your A3 Cabriolet, enabling you to customise it down to the last detail. Like your Audi, all these accessories are developed to the highest possible standards. They're all available exclusively from Audi. To find out more, just visit [audi.co.uk/accessories](http://audi.co.uk/accessories) or contact your local Audi Centre.

### Warranty

All of the accessories available on the A3 Cabriolet are covered by a three-year warranty\* if they are ordered and included in the purchase price of the car at date of delivery. Any accessories ordered and installed after delivery include a two-year warranty.\*

\*Excluding Road Angel products.

Audi Accessories warranty terms and conditions can be found at [audi.co.uk](http://audi.co.uk)



## Merchandise

From the enthusiasts' motorsport collection to the sophisticated Audi collection, there's a wide variety of adults' and children's clothing, lifestyle accessories and collectables, all of which bear the Audi name.

Please speak to a member of our team at your local Audi Centre to see the full Audi collection and to place an order. A selection of Audi merchandise is also available to buy from [audi.co.uk/merchandise](http://audi.co.uk/merchandise)



# Audi Difference

## The experts in Vorsprung durch Technik

Our Audi Approved Master Technicians have undergone an impressive 100,000 hours of training over a 10-year programme to ensure they have the latest technical expertise for maintaining and servicing your Audi. All our Service Advisors undergo a specialist induction and training to ensure they are Audi professionals and able to talk to you about any issues you may have with your Audi vehicle.

## Servicing tailored to your needs

Regular servicing is key to safeguarding your Audi's performance and a full Audi service history could help you enhance the future re-sale value. To make servicing easy, the Audi Service Schedules have been designed to work with your individual driving style and vehicle.

We offer two different schedules: the fixed Inspection Service and the variable LongLife Service schedule. The conventional fixed Inspection Service schedule has fixed intervals for the Oil-change Service and Inspection Service, which are determined by time and distance.

With the variable LongLife Service schedule, the Inspection Service intervals are also fixed but the Oil-change Service intervals are variable. Sensors take account of driving style and conditions to determine when the Oil-change Service is required and the driver is informed via the on-board service interval display.

The choice of Service Schedule will depend on journey type and mileage as well as individual driving style and conditions. The table to the right can be used for guidance but your Audi Centre will help you to determine the most suitable Service Schedule for you based on your individual circumstances and preferences.

### Fixed Inspection Service Schedule

	Vehicle usage:
Mileage	Less than 10,000 miles per annum Mainly city/town centre driving. Short journeys.
	Service intervals:
Oil-change Service	Fixed to every 9,000+ miles/1 year
Inspection Service	Fixed to every 19,000+ miles/2 years

### Variable LongLife Service Schedule

	Vehicle usage:
Mileage	More than 10,000 miles per annum Motorway and main road driving. Mainly longer distance journeys. Constant speeds.
	Service intervals:
Oil-change Service	Variable to a maximum of every 19,000+ miles/2 years
Inspection Service	Fixed to every 19,000+ miles/2 years

When a vehicle is frequently used in the following conditions, we recommend a Fixed Inspection Service Schedule, regardless of mileage:

Uneconomical driving styles, e.g. heavy acceleration and braking, constant use of high revs  
High engine-loading conditions, e.g. frequent towing and hill climbs

\*As indicated by the service interval display. Mileages are approximate as the Service Indicator system uses kilometres as its distance measurement.

## Your convenience comes first

At Audi you can choose from a range of convenient services that suit your needs. Why not book a 'service while you wait' appointment\* and enjoy our complimentary refreshments while your car is with us? Or, if you need to be mobile, take advantage of one of our courtesy cars which we can even deliver to you.\* We guarantee we can service your Audi within 5 days without a courtesy car or within 10 days if you need transport. We will also ensure your car is returned to you with a full valet.

## Audi Genuine Parts

You can rest assured that only Audi Genuine Parts will be used on your vehicle. What's more, Audi parts and labour come with a 2-year guarantee.\*\*

## No hidden costs

We believe strongly in transparency when it comes to our prices. For added peace of mind, we will give you a quotation over the phone for the work you have requested and email you the price confirmation. We'll consult you if any additional work on your car is needed when it is with us. We won't carry out any extra work without asking your permission first.

## All part of the service

Whenever we see an Audi for a service, we connect it directly to our headquarters in Ingolstadt which enables us to check your car's software and make sure it's as up-to-date as possible. If the factory has released a software upgrade for your model, it can be applied immediately - improving anything from your car's efficiency to the precision of its parking system.

## Audi Roadside Assistance

Your new car comes complete with 3 years' complimentary roadside assistance and recovery across the UK, provided by RAC Motoring Services. Also included is roadside assistance throughout Europe, managed by RAC Motoring Services.

For further information and terms and conditions please visit [audi.co.uk](http://audi.co.uk)

\* Subject to availability.

\*\*Excludes wear and tear.







# A3 Cabriolet technical data

	Petrol		Diesel
	1.4 TFSI*	1.8 TFSI	2.0 TDI
Engine	1.4 TFSI*	1.8 TFSI	2.0 TDI
Transmission	6-speed manual	7-speed S tronic	6-speed manual
Cylinder	4-cylinder	4-cylinder	4-cylinder
Displacement, cubic cm (valves per cylinder)	1395	1798	1968
Max. power <sup>1</sup> , PS at rpm	140/5000	180/5100-6200	150/3500-4000
Max. torque, Nm at rpm	250/1500-3500	250/1250-5000	340/1750-3000
Top speed <sup>2</sup> , mph	135	150	139
0-62mph acceleration, seconds	9.1	7.8	8.9
CO <sub>2</sub> emissions <sup>3</sup> , g/km	114	133	110
Benefit in kind (BIK)%	14%	18%	17%
Fuel consumption <sup>1</sup> , mpg (l/100km) Urban	46.3 (6.1)	38.7 (7.3)	55.4 (5.1)
Fuel consumption <sup>1</sup> , mpg (l/100km) Extra Urban	65.7 (4.3)	58.9 (4.8)	76.3 (3.7)
Fuel consumption <sup>1</sup> , mpg (l/100km) Combined	56.5 (5.0)	48.7 (5.8)	67.3 (4.2)
ABI insurance group 1-50 <sup>4</sup>	TBC	TBC	TBC
Unladen weight <sup>4</sup> , kg	1365	1430	1460
Gross weight limit, kg	1865	1930	1960
Nose weight, kg	75	75	75
Max trailer load unbraked <sup>5</sup> , kg	720	750	750
Max trailer load with 12% gradient <sup>5</sup> , kg	1500	1600	1600
Max trailer load with 8% gradient <sup>5</sup> , kg	1700	1800	1800
Luggage compartment capacity, seats folded up/down, litres	320/678	320/678	320/678
Fuel tank capacity approx, litres	50	50	50
Emission standard	EU6	EU6	EU6

\*1.4 TFSI engine with Audi cylinder-on-demand technology.

<sup>4</sup>Highest insurance group rating shown. Group may be lower dependent on trim level. Please visit [www.thatcham.org/abigrouprating](http://www.thatcham.org/abigrouprating) for details.

**Please note:** The maximum power output figures are quoted in PS (or Pferdestärke, which is the metric equivalent of brake horsepower). To convert to brake horsepower, divide the PS figure by 1.0139.

<sup>1</sup>The given value was obtained in accordance with the specified measurement procedure (the respective current version of the Directive 80/1269/EEC).

<sup>2</sup>Top speed is achieved in top gear.

<sup>3</sup>Fuel consumption and CO<sub>2</sub> emissions figures are obtained under standardised test conditions (Directive 93/116/EEC) using a representative model. This allows direct comparison between different models from different manufacturers, but may not represent the actual fuel consumption achieved in 'real world' driving conditions. More information is available at [www.vca.gov.uk](http://www.vca.gov.uk).

<sup>4</sup>Vehicle's unladen weight without driver (calculated in accordance with the current version of Directive 80/1268/EEC). The fitting of additional equipment may increase the vehicle's unladen weight and drag coefficient, whereupon the potential carrying capacity and top speed will be correspondingly reduced.

<sup>5</sup>The engine's power output always goes down with increasing altitude. At 1,000m above sea level, and for every additional 1,000m, deduct 10% from the weight of the outfit (trailer load limit + gross weight of the towing vehicle).

## A3 Cabriolet dimensions

The technical drawings opposite show the exact dimensions of the new Audi A3 Cabriolet, so you can check everything – from whether the car will fit in your garage to whether your luggage will fit in the boot.

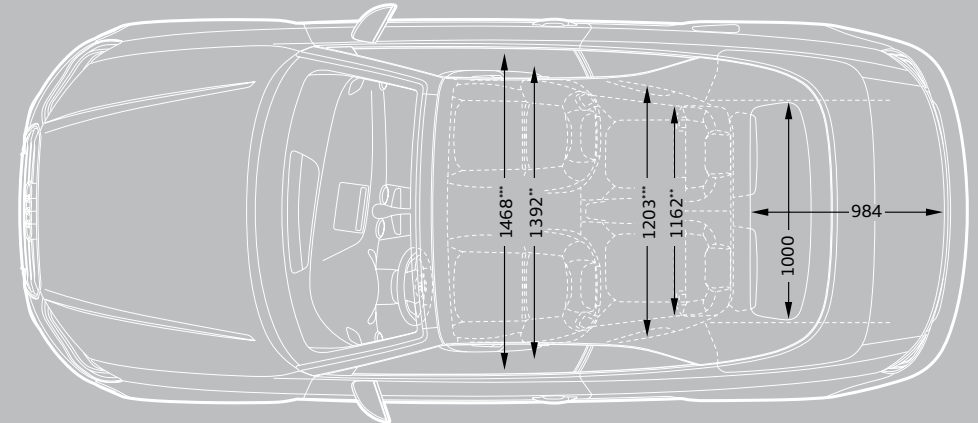
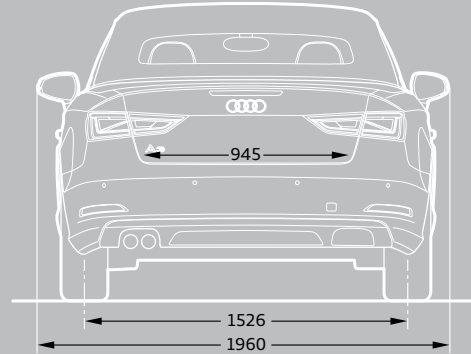
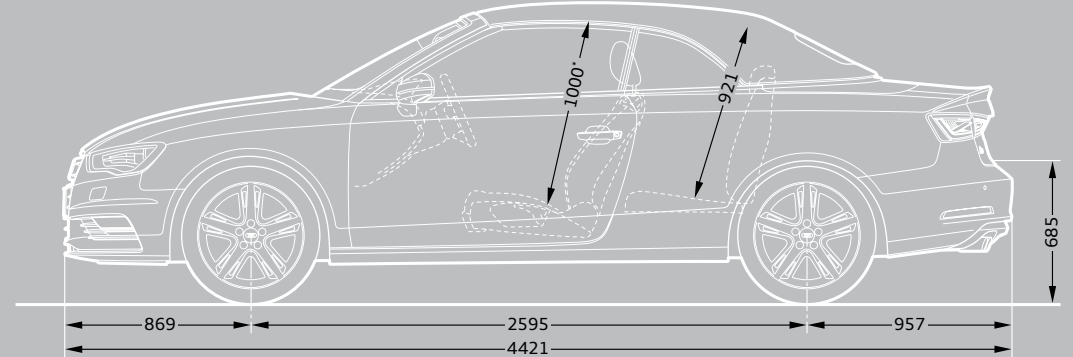
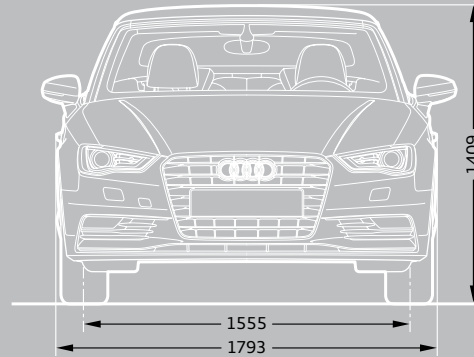

\*Maximum headroom.

\*\*Elbow room width.

\*\*\*Shoulder room width.

Dimensions in millimetres.

Turning circle approx 10.9m.

Dimensions measured with vehicle at unladen weight.

# Pricing and Additional information

## Welcome to Audi

By placing an order for your Audi, you're choosing to get behind the wheel of one of the most sophisticated cars on the road. And because we believe the service we offer should be just as advanced, we want to let you know exactly what you can expect from us, now and in the future.

We've agreed a set of standards with all our Centres which governs the way we do business with you. It outlines the kind of service we promise to deliver for every customer, right down to filling each new Audi we sell with half a tank of fuel.

So whether you're interested in the date your car will arrive in the UK or the way we'll dispose of non-biodegradable materials after we service your Audi, you can have total confidence in us.

## Audi Promise

### Audi Centres

We guarantee that all our Centres will be open as follows:

Sales: Monday to Friday 9am–6pm  
Saturday 9am–5pm

Service: Monday to Friday 8am–6pm  
Saturday 8.30am–1pm

Sunday opening is at local discretion.

### New car delivery

Once we've confirmed a delivery date for your car, we'll keep you informed of progress. Subject to reasonable notice, we'll then deliver it to a place of your choice, whether that's your home or work. In the unlikely event of a delay, we'll provide a courtesy car to minimise inconvenience and keep you mobile.

### Environmental commitment

We promise to dispose of all non-biodegradable materials from your vehicle in a responsible manner.

### Pricing

Prices and specifications given are correct at the time of printing. Always check details with your Audi Centre as Audi policies are continually developing. We reserve the right to change prices or specifications at any time.

All prices are subject to VAT, currently charged at 20%, but this may alter to reflect any change in the applicable VAT rate.

Delivery charges and number plates are not included in the vehicle price.

Delivery charge	£471.66
Number plate	£20.00
VAT	£98.34
Total	£590.00

## Audi Customer Care

Every new Audi benefits from the comprehensive Audi Customer Care Package, which comprises:

- ▶ A 3-year Audi warranty, which covers you for unlimited mileage in the first 2 years of ownership, with a full mechanical and electrical warranty which covers you for up to 60,000 miles in the 3rd year
- ▶ A 3-year paint warranty
- ▶ A 12-year anti-corrosion warranty
- ▶ 3 years' UK roadside assistance and recovery

You also have the option when ordering your new car of choosing a 4-year or 5-year Audi warranty. Speak to a member of the sales team for more information.

### Audi tax-free sales

If you are entitled to purchase a vehicle free of VAT, normally through military or diplomatic privilege, please contact your local Audi Centre for full details.

Should you have any difficulty obtaining the information you require, please call 01908 548 356.

### Audi Finance

Audi Finance specialises in providing funding solutions for Audi drivers. Whether your Audi is for private or business use, there is a range of funding options to choose from.

Below is the full range of finance products, which comprises:

- ▶ Solutions – a Personal Contract Plan
- ▶ Hire purchase
- ▶ Lease purchase
- ▶ Finance lease
- ▶ Contract hire

With all products, you can choose a fixed-cost maintenance plan designed to help you budget accurately.

No matter which Audi model you choose, your local Audi Centre can provide you with a personalised quote designed to fit your budget and motoring needs.

Audi Finance is a trading name of Volkswagen Financial Services (UK) Limited. An offer of finance depends on certain conditions. Available to people over 18 in the UK only.

### Audi Insurance

We want you to start enjoying your new car from day one and thanks to Audi Insurance complimentary 7-day cover, you can. Call free on 0800 316 7893 (lines are open Monday to Friday 8am–9pm, and Saturday 9am–5pm), provide a few details and a cover note will be sent to your Audi Centre. They will then tax your car and you can drive it away.



## Additional information

### CO<sub>2</sub> data and information

#### CO<sub>2</sub> emissions-based Vehicle Excise Duty

Vehicle Excise Duty (Road Fund Licence) is based upon the amount of Carbon Dioxide (CO<sub>2</sub>) a vehicle emits, measured in grams per kilometre (g/km). First year VED rates apply to the first year of ownership. Annual VED rates apply thereafter. The DVLA has created thirteen categories:

Petrol and Diesel engines	First year	Annual rate (second year onwards)
A – up to 100g/km	£0.00	£0.00
B – 101 to 110g/km	£0.00	£20.00
C – 111 to 120g/km	£0.00	£30.00
D – 121 to 130g/km	£0.00	£105.00
E – 131 to 140g/km	£125.00	£125.00
F – 141 to 150g/km	£140.00	£140.00
G – 151 to 165g/km	£175.00	£175.00
H – 166 to 175g/km	£285.00	£200.00
I – 176 to 185g/km	£335.00	£220.00
J – 186 to 200g/km	£475.00	£260.00
K – 201 to 225g/km	£620.00	£280.00
L – 226 to 255g/km	£840.00	£475.00
M – over 255g/km	£1,065.00	£490.00

Vehicle Excise Duty (VED) rates correct at time of going to print, but these may alter to reflect any change in the applicable VED rate.













**Audi UK**  
Customer Services  
Selectapost 29  
Sheffield  
S97 3FG  
0800 699888  
audi.co.uk

Specifications and prices subject  
to change without notice.

© Audi (UK)

Printed in the UK  
Edition 0.2 10/13  
2015 model year

Images are for illustrative purposes only.

