



**The Audi A3 Cabriolet**  
Pricing and Specification Guide  
Valid from October 2011

# Personalising your Audi A3 Cabriolet

This guide has been designed to help you tailor and price your Audi A3 Cabriolet quickly and logically. At the back, you will find information on CO2 emissions-based taxation and the other services offered by Audi, including Finance and Insurance. You can also configure your Audi A3 Cabriolet online at [audi.co.uk](http://audi.co.uk).

You might also like to consider Audi Complete: a simple way to take care of servicing and maintenance costs for your Audi in a single package. You pay a one-off or monthly fee and we'll cover all your servicing, maintenance and tyres for the next three years including your first MOT and a full 5-year warranty. It means you only have to pay for fuel, insurance and your Road Fund Licence. So you can be reassured that your car will be maintained by trained Audi Technicians, using genuine Audi parts.

**Audi Complete™**

## The Audi A3 Cabriolet

Efficiency	8
Engines	10
Transmissions	11

## Model details and prices

Standard model equipment	12
Sport model equipment	14
S line model equipment	15
Model prices	16

<b>Audi exclusive</b>	18
-----------------------	----

## Colour and upholstery

Paint and hoods	20
Upholstery	22
Colour and trim guide	26
Inlays	30

## Options

Wheels and tyres	32
Packages	34
Audio and communication	36
Seats	38
Safety and security	39
Steering wheels	40
Interior equipment	42
Exterior equipment	43
Audi Complete and warranty	44
Merchandise	45
Accessories	46

## Technical details

Technical data	47
Dimensions	49
Additional information	50
Pricing information	52





## Vorsprung durch Technik

Three words that express the very essence of Audi. Vorsprung durch Technik isn't a slogan. It's our way of seeing the world. It is the driving force behind our history of innovation that continues into the 21st century. Indeed, many technologies that Audi pioneered remain in our cars today. Some are milestones in the history of the motorcar.

From our beginnings in 1899 to the Auto Union team's Grand Prix successes in the 1930s and our more recent wins at Le Mans, we have always been at the forefront of the motor industry.

Vorsprung durch Technik makes us who we are. To see more of its influence, just read on.

## The A3 Cabriolet, with a roof that closes in just 11 seconds

With the Audi A3 Cabriolet, we've taken all the qualities you'd associate with Audi – stunning design, sporty looks and progressive styling – and brought them one step further. From the sweeping, expressive lines of the body to the smooth silhouette of the canvas hood, which closes in just 11 seconds and can be operated at speeds up to 18mph,\* it's got all the dynamic character and appeal of a coupé. And even more impressively, we've combined this with the everyday practicality of increased luggage capacity and space for four people.





## Efficiency

At Audi, doing less is something we're trying to do more of. We're working to use less fuel, release less CO<sub>2</sub> and waste less energy. It's why we've incorporated a number of more efficient technologies into the Audi A3 Cabriolet.

### **S tronic®**

Efficient driving is all about thinking ahead, which is what the optional S tronic® transmission does in the Audi A3 Cabriolet. When you're accelerating in second gear, it's preparing to step up to third. Once the switch happens, it's already thinking about fourth. Thanks to two clutches working together, gear changes occur almost instantly, leading to smoother acceleration and increased economy.

### **Gear-change indicator**

Small changes to your driving style can have a big impact on your fuel economy. The gear-change indicator in the Audi A3 Cabriolet is there to indicate the optimum gear to use for any given speed, encouraging early upshifts to ensure you don't burn more fuel than necessary.





### **Aerodynamics**

A car's shape is one of the most important factors that influences its efficiency. That's why we've worked to make the Audi A3 Cabriolet as aerodynamic as possible.



## Engines

### Petrol

FSI® direct-injection technology is a unique Audi innovation that was originally developed for the Le Mans 24-hour endurance race to deliver more power and torque, as well as enhanced fuel efficiency. Precisely the right amount of fuel and air are injected into the combustion chambers, enabling the engine to 'breathe' more easily. It results in reduced heat loss and increased output, with around a 15% reduction in fuel consumption and significantly lower exhaust emissions. We've also developed TFSI®, with turbocharging, which combines FSI® technology with forced induction – giving cars an extra injection of power.

### Diesel

We introduced TDI® to the roads in 1989, marking a departure from the noisy, fuel-thirsty diesel engines of the past. And since then, we've continuously refined it, recently developing common-rail technology. Under this system, a series of piezo injectors use electrical charge to precisely control the amount of fuel injected into the engine. As well as reducing noise, this allows combustion to happen at a lower temperature and with less oxygen, which lowers emissions.





## Transmissions

### **S tronic®**

The revolutionary S tronic® gearbox combines the agility and responsiveness of a conventional 6-speed manual gearbox with the convenience and smooth, uninterrupted power of an automatic transmission. The technical basis of the S tronic® gearbox is the double clutch. This consists of two lubricated plates with hydraulically-regulated contact pressure. One engages the odd-numbered gears, the other the even-numbered, enabling gear-shifts to be made in a fraction of a second, with no disruption to the power flow. Depending on how the mood takes you, you can either allow gear-changes to take place automatically or, for a sportier driving style, operate the S tronic® system using the gear lever or steering wheel shift-paddles. The choice is yours.

### **7-speed S tronic®**

The 1.8 TFSI® model is available with a 7-speed version of our highly-acclaimed S tronic® gearbox. The extra gear, along with a dry-clutch set-up, results in improved fuel economy and lower CO<sub>2</sub> emissions. As with the 6-speed S tronic® gearbox, this gear system can be operated in fully automatic mode, or using the gear lever or steering wheel gear-shift controls for an even more engaging drive.

# Standard model equipment

All A3 Cabriolet models have the following items of standard equipment

## Engines

Automatic Start-Stop function for greater fuel and CO<sub>2</sub> efficiency. Comprising:

- Recuperation for optimal energy utilisation
- Energy saving tips feature in Driver's Information System: including gear-shift indicator (if fitted)

(Only available on 1.2 TFSI, 1.6 TDI and 2.0 TDI 140PS)

## Wheels, tyres and suspension

16" x 6.5J '7-arm' design alloy wheels with 225/55 R16 tyres

Locking wheel bolts

Tyre mobility system

## Audio and communication

Chorus radio/single CD player with front speakers

## Seats

Driver and front passenger manual seat height adjustment

Easy entry front seats

'Frequency' cloth upholstery

Seat belts - 3-point on all four seats

Split-folding rear seats (50:50)

## Safety and security

Audi backguard head restraints for front seats (adjustable)

Driver, front passenger and side airbags for front seats

Electronic Stability Programme (ESP), including ABS, EBD, ASR and EDL

Front and rear ISOFIX child seat preparation (front passenger seat with airbag deactivation switch)

Halogen daytime-running lights

Halogen headlights

Rear fog light

Rear head restraints

Remote-control central locking

Roll-over protection bars

Servotronic - electromechanical, speed-sensitive, power-assisted steering

Thatcham Category 1 Alarm and Immobiliser

Warning triangle

Tool kit and car jack

## Interior equipment

4-spoke leather steering wheel (manual models only)

3-spoke leather Sports steering wheel with gear-shift paddles (S tronic models only)



16" x 6.5J '7-arm' design alloy wheels



Driver, front passenger and side airbag for front seats

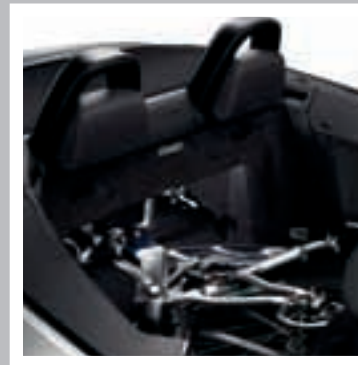

Split-folding rear seats (50:50)

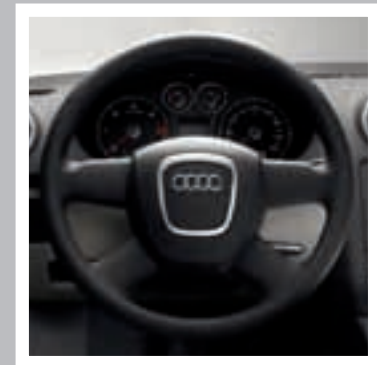

4-spoke leather steering wheel

Electric front and rear windows

Front and rear floor mats

Granite or Umbra inlays and door trim  
(depending on upholstery colour – see  
page 30)

Heated rear glass screen

Heat-insulating glass

Illuminated vanity mirrors

Manual air conditioning

Manual headlight adjustment

Steering wheel adjustment for height  
and reach

Washer fluid level indicator

### Exterior equipment

Body-coloured door mirrors with  
integrated indicators

Chrome trim on door handles

Electrically-operated and heated  
door mirrors

Fully automatic, acoustic hood,  
with one touch and key operation  
– opens in nine seconds and can be  
operated at speeds of up to 18mph.



# Sport model equipment

## In addition to Standard model equipment

**Basic RRP**  
£1,575.00

**Total RRP inc VAT**  
£1,890.00

### Wheels, tyres and suspension

17" x 7.5J '5-arm kinetic' design alloy wheels with 225/45 R17 tyres

Sports suspension (lowered by 15mm)

### Audio and communication

Concert radio with single front-loading CD player, MP3 file compatibility and active front and rear speakers. Includes AUX-IN socket in front-centre compartment

### Seats

Front Sports seats

'Dynamic' cloth upholstery

### Safety and security

Front fog lights with chrome surrounds

### Interior equipment

3-spoke leather Sports multi-function steering wheel (with gear-shift paddles on S tronic models)

Door sills with aluminium inlays

Dual-zone electronic climate control

Driver's Information System with energy saving tips feature including gear-shift indicator

Wind deflector

Front centre armrest

### Exterior equipment

Exterior aluminium design trim: roll bars, shoulder line trim



17" x 7.5J '5-arm kinetic' design alloy wheels



Dual-zone electronic climate control



Exterior aluminium design trim (roll bars)



Front fog lights

# S line model equipment

## In addition to Sport model equipment

**Basic RRP**  
£1,320.83

**Total RRP inc VAT**  
£1,585.00

### Wheels, tyres and suspension

18" x 7.5J '7-twin-spoke' design alloy wheels with 225/40 R18 tyres

### Seats

Black Sprint cloth/leather upholstery with embossed S line logo

### Interior equipment

Black leather handbrake trim

Black perforated leather gear knob

Black headlining

Door sills with aluminium inlays and S line lettering

Floor mats with black or silver stitching

Matt-brushed aluminium inlays and door trims

S line leather multi-function steering wheel (with gear-shift paddles on S tronic models)

### Exterior equipment

Chrome-trimmed exhaust tailpipes

S line badges on front wings

S line body styling comprising front bumper with enhanced fins and rear bumper with Platinum grey diffuser insert

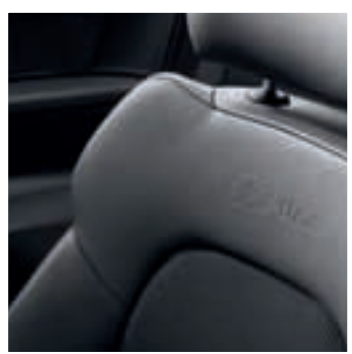

Black Sprint cloth/leather upholstery with embossed S line logo



Door sills with aluminium inlays and S line lettering



S line leather multi-function steering wheel



18" x 7.5J '7-twin-spoke' design alloy wheels

## A3 Cabriolet Standard

Engines	Power	Transmissions	CO <sub>2</sub> g/km	Basic RRP	Total RRP inc VAT	Recommended OTR
1.2 TFSI	105PS	6-speed manual	132	£17,016.67	£20,420.00	£21,180.00
1.8 TFSI	160PS	6-speed manual	156	£19,400.00	£23,280.00	£24,090.00
2.0 TFSI	200PS	6-speed manual	169	£20,558.33	£24,670.00	£25,580.00
1.6 TDI	105PS	5-speed manual	114	£18,325.00	£21,990.00	£22,635.00
2.0 TDI	140PS	6-speed manual	119	£19,829.17	£23,795.00	£24,440.00

## A3 Cabriolet Sport

Engines	Power	Transmissions	CO <sub>2</sub> g/km	Basic RRP	Total RRP inc VAT	Recommended OTR
1.2 TFSI	105PS	6-speed manual	132	£18,591.67	£22,310.00	£23,070.00
1.8 TFSI	160PS	6-speed manual	156	£20,975.00	£25,170.00	£25,980.00
2.0 TFSI	200PS	6-speed manual	169	£22,133.33	£26,560.00	£27,470.00
1.6 TDI	105PS	5-speed manual	114	£19,900.00	£23,880.00	£24,525.00
2.0 TDI	140PS	6-speed manual	119	£21,404.17	£25,685.00	£26,330.00

**Please note:** The maximum power output figures are quoted in PS (or Pferdestärke, which is the metric equivalent of brake horsepower). To convert to brake horsepower, divide the PS figure by 1.0139.

**Recommended On-The-Road (OTR) retail prices include:** delivery charge, half a tank of fuel, number plates at £590.00 (inc. VAT), Road Fund Licence (which may vary depending on model/transmission – see page 50 for details) and first registration fee at £55.00. Vehicle Excise Duty correct at time of going to print, but this may alter to reflect any change in the applicable VED rate.

RRP – Recommended Retail Price. VAT is calculated at 20% but this may alter to reflect any change in the applicable VAT rate.

## A3 Cabriolet S line

Engines	Power	Transmissions	CO <sub>2</sub> g/km	Basic RRP	Total RRP inc VAT	Recommended OTR
1.2 TFSI	105PS	6-speed manual	132	£19,912.50	£23,895.00	£24,655.00
1.8 TFSI	160PS	6-speed manual	156	£22,295.83	£26,755.00	£27,565.00
2.0 TFSI	200PS	6-speed manual	169	£23,454.17	£28,145.00	£29,055.00
1.6 TDI	105PS	5-speed manual	114	£21,220.83	£25,465.00	£26,110.00
2.0 TDI	140PS	6-speed manual	119	£22,725.00	£27,270.00	£27,915.00

## Transmissions

	6-speed S tronic*	7-speed S tronic*
1.2 TFSI	–	–
1.8 TFSI	–	●
2.0 TFSI**	●	–
1.6 TDI	–	–
2.0 TDI	●	–
<b>Basic RRP</b>	£1,233.33	£1,233.33
<b>Total RRP<sup>inc. VAT</sup></b>	£1,480.00	£1,480.00

– = Not available      ● = Available      S = Standard

\*Includes steering wheel gear-shift paddles.

\*\*Not available on Standard models.





## Audi exclusive



Every Audi is intrinsically exclusive. It's the breathtaking design, the exceptional engineering, the Vorsprung durch Technik. But for that special touch you can specify your new Audi A3 Cabriolet with options from Audi exclusive. Whether you want a unique, custom-mixed paint colour or seats in a combination of complementary shades, Audi exclusive will enable you to drive the car you've always imagined.

Both the exclusive and standard options can be found on the following pages.

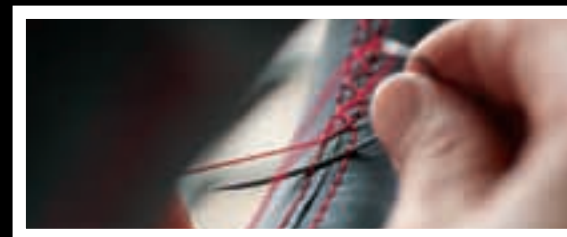

# Paint and hood colours

You can select one of the standard colours shown opposite or, for a different look, choose from the range of optional finishes.

Options are subject to availability and may extend delivery.

All the colour swatches on this page are matched as accurately as possible to the actual paint colours used. However, due to print processes, Audi UK cannot guarantee that colours shown are 100% accurate.

Visit your local Audi Centre for a more accurate colour swatch.

RRP – Recommended Retail Price.

VAT is calculated at 20% but this may alter to reflect any change in the applicable VAT rate.

## Standard colours



Ibis white – T9

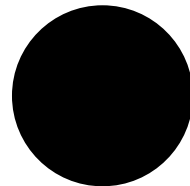

Brilliant black – A2

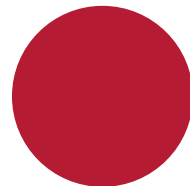

Brilliant red – C8

## Optional colours

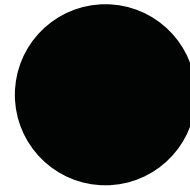

Phantom black, pearl effect – L8

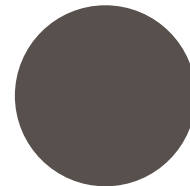

Dakota grey, metallic – Y7

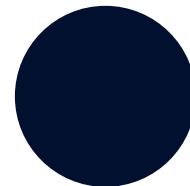

Deep sea blue, pearl effect – 8A

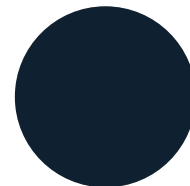

Meteor grey, pearl effect – X5

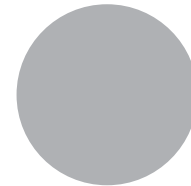

Ice silver, metallic – P5

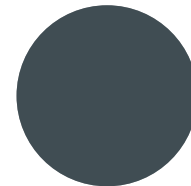

Condor grey, metallic – 5Q

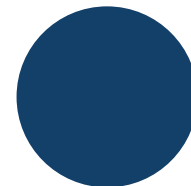

Scuba blue, metallic – S9



Glacier white, metallic – 2Y

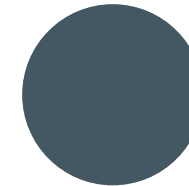

Sphere blue, metallic – 9F

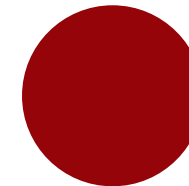

Volcano red, metallic – 1G

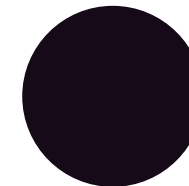

Tungsten grey, metallic – 1J

## S line colours

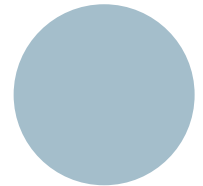

Monza silver, metallic – U7

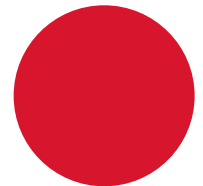

Misano red, pearl effect – N9

### Optional colours

**Basic RRP**

£425.00

**Total RRP inc VAT**

£510.00

## Hood colours



Red - SF



Black - PA



Blue - PB

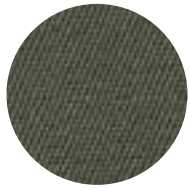

Beige - PD

# Paint

## Audi exclusive

Everyone has a favourite colour. No matter what yours is, Audi exclusive provides a range of unique colours that have been designed to set your car apart. Choose from the swatches here, or specify any other paint colour in the Audi range – whether it's Jet blue from the Audi R8 or Alpine white from the original Audi quattro. The choice is yours.

## Customised

If you have a particular colour in mind, we'll mix the exact metallic or pearl-effect shade you want.\*

\*Custom paint is subject to factory approval, and is available for metallic and pearl-effect water-based paints only. Three-colour process colours and two-tone schemes are not available.

\*Visit your local Audi Centre for colour samples.

All the colour swatches on this page are matched as accurately as possible to the actual paint colours used. However, due to print processes, Audi UK cannot guarantee that colours shown are 100% accurate.

Visit your local Audi Centre for a more accurate colour swatch.

RRP - Recommended Retail Price.

VAT is calculated at 20% but this may alter to reflect any change in the applicable VAT rate.

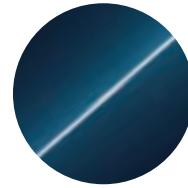

Palace blue, pearl effect

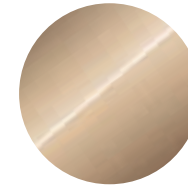

Sand beige, pearl effect

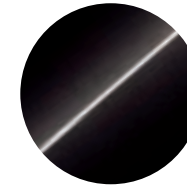

Saddle brown, pearl effect

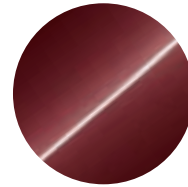

Classic red, pearl effect

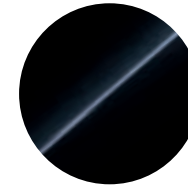

Mamba black, metallic

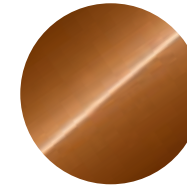

Ipanema brown, metallic



Any colour in the Audi range



100 Audi exclusive colours to choose from\*



Customised paint

### Audi exclusive

**Basic RRP**

£1,445.83

**Total RRP inc VAT**

£1,735.00

### Customised

**Basic RRP**

£2,041.67





**Total RRP inc VAT**

£2,450.00

# Upholstery

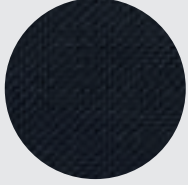
## Standard models

Choose your favourite upholstery from the swatches shown opposite to give your car's interior the look and feel you want.

	Standard	Sport	S line	Basic RRP	Total RRP inc VAT
<b>Frequency cloth</b>  Black - <b>JN/CA</b>  Light grey - <b>BJ/BR</b>	S	-	-	No charge	No charge
<b>Vienna leather</b>  Black - <b>JN/CA</b>  Light grey - <b>BJ/BR</b>  Luxor beige - <b>TB</b>	●	-	-	£866.67	£1,040.00

Options are subject to availability and may extend delivery.

- = Not available  
 ● = Available  
 S = Standard









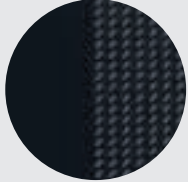
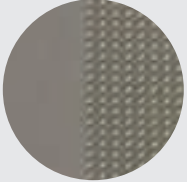
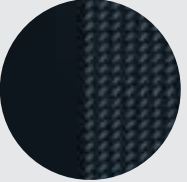
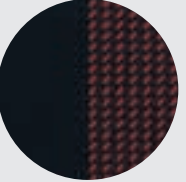

All leather upholstery choices include seats, head restraints, door inserts and front centre armrest (if fitted) in leather.

RRP - Recommended Retail Price.

VAT is calculated at 20% but this may alter to reflect any change in the applicable VAT rate.

# Upholstery

## Sport models

					Standard	Sport	S line	Basic RRP	Total RRP inc VAT	
Dynamic cloth					-	S	-	No charge	No charge	
	Black/Silver – <b>BC/BK</b>	Light grey – <b>BJ/BR</b>	Black/Blue – <b>BD/BL</b>	Black/Red – <b>BE/BM</b>						
	Leather/Alcantara					-	•	-	£841.67	£1,010.00
		Black – <b>JN/CA</b>	Light grey – <b>BG/BP/BJ/BR</b>							
Vienna leather					-	•	-	£866.67	£1,040.00	
	Black – <b>JN/CA</b>	Light grey – <b>BJ/BR</b>	Luxor beige – <b>TB</b>	Silk beige – <b>ES</b>						
	Fine Nappa leather					-	•	-	£1,037.50	£1,245.00
		Black – <b>JN/CA</b>	Mustang brown – <b>JZ/BN</b>	Red – <b>BF/BQ</b>						

Options are subject to availability and may extend delivery.

- = Not available
- = Available
- S = Standard

All leather upholstery choices include seats, head restraints, door inserts and front centre armrest (if fitted) in leather.

Leather/Alcantara choices include seats, head restraints, seat-side bolster and front centre armrest in leather with the seat centres and door panels in Alcantara.



RRP – Recommended Retail Price.

VAT is calculated at 20% but this may alter to reflect any change in the applicable VAT rate.

# Upholstery

## S line models

Choose your favourite upholstery from the swatches shown opposite to give your car's interior the look and feel you want.

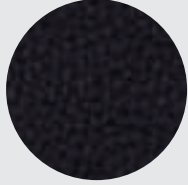
	Standard	Sport	S line	Basic RRP	Total RRP inc VAT
<b>Sprint cloth/Leather</b>  Black - QF/QE	-	-	S	No charge	No charge
<b>Leather/perforated Alcantara</b>  Black - QF/QE	-	-	•	£416.67	£500.00
<b>Vienna leather</b>  Black - QE	-	-	•	£612.50	£735.00

Options are subject to availability and may extend delivery.

- = Not available
- = Available
- S = Standard

All leather upholstery choices include seats, head restraints, door inserts and front centre armrest (if fitted) in leather.

Leather/Alcantara choices include head restraints, seat-side bolster and front centre armrest in leather with the seat centres and door panels in Alcantara.

RRP - Recommended Retail Price.

VAT is calculated at 20% but this may alter to reflect any change in the applicable VAT rate.





# Colour and trim guide

## Interior trim colours

### Standard models

To help you choose the right interior for your new A3 Cabriolet, please use this guide, showing the carpet, dashboard and headlining colours that have been matched to your chosen upholstery.

### Sport models

### S line models

Options are subject to availability and may extend delivery.

- = Not available  
• = Available  
S = Standard

Order Code	Upholstery	Carpet	Dashboard (upper/lower)	Headlining	Frequency cloth (N5G)	Vienna leather (N1A)	Leather/Alcantara (N7U)	Fine Nappa leather (N3Q)
JN	Black	Black	Black/Black	Black	•	•	—	—
CA	Black	Black	Black/Black	Silver	•	•	—	—
BJ	Light grey	Light grey	Black/Light grey	Black	•	•	—	—
BR	Light grey	Light grey	Black/Light grey	Silver	•	•	—	—
TB	Luxor beige	Luxor beige	Black/Black	Black	—	•	—	—

Order Code	Upholstery	Carpet	Dashboard (upper/lower)	Headlining	Dynamic cloth (N5B)	Vienna leather (N1A)	Leather/Alcantara (N7U)	Fine Nappa leather (N3Q)
BJ	Light grey	Light grey	Black/Light grey	Black	•	•	•	—
BR	Light grey	Light grey	Black/Light grey	Silver	•	•	•	—
BC	Black/Silver	Black	Black/Black	Black	•	—	—	—
BK	Black/Silver	Black	Black/Black	Silver	•	—	—	—
BD	Black/Blue	Black	Black/Black	Black	•	—	—	—
BL	Black/Blue	Black	Black/Black	Silver	•	—	—	—
BE	Black/Red	Black	Black/Black	Black	•	—	—	—
BM	Black/Red	Black	Black/Black	Silver	•	—	—	—
JN	Black	Black	Black/Black	Black	—	•	•	•
CA	Black	Black	Black/Black	Silver	—	•	•	•
ES	Silk beige	Black	Black/Black	Black	—	•	—	—
TB	Luxor beige	Luxor beige	Black/Black	Black	—	•	—	—
BG	Light grey	Black	Black/Black	Black	—	—	•	—
BP	Light grey	Black	Black/Black	Silver	—	—	•	—
JZ	Mustang brown	Black	Black/Black	Black	—	—	—	•
BN	Mustang brown	Black	Black/Black	Silver	—	—	—	•
BF	Red	Black	Black/Black	Black	—	—	—	•
BQ	Red	Black	Black/Black	Silver	—	—	—	•

Order Code	Upholstery	Carpet	Dashboard (upper/lower)	Headlining	Sprint cloth/leather (N7V)	Vienna leather (N1R)	Leather/perforated Alcantara (N7K)
QF	Black (with silver stitching)	Black	Black/Black	Black	•	—	•
QE	Black (with black stitching)	Black	Black/Black	Black	•	•	•

# Colour and trim guide

## Hood and paint combinations

To help you choose the right exterior for your A3 Cabriolet, please use this guide which shows recommended paint and hood colour combinations.

Order Code	Exterior colour	Black (PA)	Blue (PB)	Red (SF)	Beige (PD)
A2	Brilliant black	●	●	●	●
C8	Brilliant red	●	—	●	●
T9	Ibis white	●	●	●	—
P5	Ice silver, metallic	●	●	●	—
9F	Sphere blue, metallic	●	●	—	—
1J	Tungsten grey, metallic	●	—	—	●
5Q	Condor grey, metallic	●	●	●	●
Y7	Dakota grey, metallic	●	●	●	●
L8	Phantom black, pearl effect	●	●	●	●
X5	Meteor grey, pearl effect	●	●	●	●
S9	Scuba blue, metallic	●	●	—	●
1G	Volcano red, metallic	●	—	●	●
8A	Deep sea blue, pearl effect	●	●	—	●
2Y	Glacier white, metallic	●	—	●	—
U7	Monza silver, metallic*	●	—	—	—
N9	Misano red, pearl effect*	●	—	●	—

Options are subject to availability and may extend delivery.

- = Not available
- = Available
- S = Standard

\*Only available on S line models

# Upholstery

## Audi exclusive

With Audi exclusive, you can specify your seats in Fine Nappa leather or Fine Nappa leather/Alcantara, in an array of different colours shown to the right.

Select just one all-over shade for each seat, or customise each panel in two or more complementary colours from the distinctive Audi exclusive palette. You can even choose the colour of the decorative stitching – to match or contrast with your chosen upholstery – from this varied collection. Whatever combination you decide upon, we think you'll be extremely comfortable with the result.

Options are subject to availability and may extend delivery.

– = Not available  
• = Available  
S = Standard

\*Leather, stitching and piping (where applicable) can be specified in a variety of colours from the Audi exclusive range.

RRP – Recommended Retail Price.

VAT is calculated at 20% but this may alter to reflect any change in the applicable VAT rate.

Order Code		Standard	Sport	S line	Basic RRP	Total RRP inc VAT
PYA S3G	<b>Audi exclusive leather package 1 in Fine Nappa leather.</b> Includes leather-covered seat upholstery and front centre armrest, Alcantara door trim inserts and floor mats with leather piping. Backrest covers and seat add-on parts come in the interior trim colour. (Only in combination with Sports seats)*	–	•	–	£2,541.67	£3,050.00
		–	–	•	£2,279.17	£2,735.00
PYC S3G	<b>Audi exclusive leather package 1 in Fine Nappa leather/Alcantara.</b> Includes leather-covered seat-side trims, head restraints, front centre armrest and door trim inserts, Alcantara seat-centre sections and floor mats with leather piping. Backrest covers and seat add-on parts come in the interior trim colour. (Only in combination with Sports seats)*	–	•	–	£2,525.00	£3,030.00
		–	–	•	£2,262.50	£2,715.00
YUG S3G	<b>Audi exclusive leather-covered roll-over protection bars*</b>	•	•	•	£504.17	£605.00



Chestnut brown

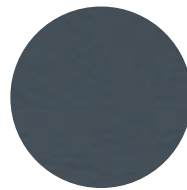

Jet grey



Alabaster white

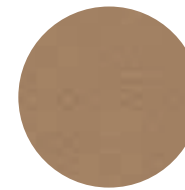

Sand beige

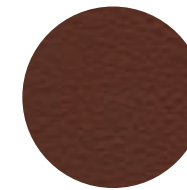

Saddle brown



Crimson red



Magnolia white

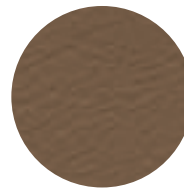

Havanna brown

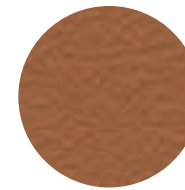

Cognac brown

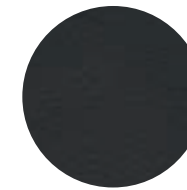

Night blue

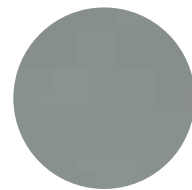

Cloudy grey

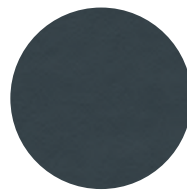

Smoky blue



Iceland green

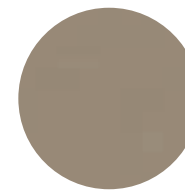

Powder beige

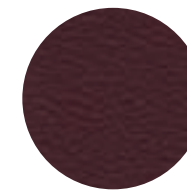

Classic red

### Also available:

**Alcantara colours:** available in all the Audi exclusive colours shown, except for Crimson red, Jet grey and Sand beige. Alcantara equivalents are Chilli red, Amethyst grey, and Sesame beige respectively.

Please consult your Audi Centre for examples of Alcantara and carpet colours.



# Inlays

Inlays are the all-important finishing touch that add flair and interest to your car's interior.

Order Code		Standard	Sport	S line	Basic RRP	Total RRP inc VAT
—	Granite*	S	—	—	No charge	No charge
—	Umbra*	S	—	—	No charge	No charge
5TD	Aluminium medial	—	S	—	No charge	No charge
5TG	Matt-brushed aluminium	—	—	S	No charge	No charge
5TL	Piano finish, black	—	—	●	No charge	No charge
5ME	Vavona wood, bernstein (includes wooden gear knob on manual transmission)	●	—	—	£304.17	£365.00
		—	●	—	£150.00	£180.00
5MP	Burr walnut wood, dark brown	●	—	—	£304.17	£365.00
		—	●	—	£150.00	£180.00

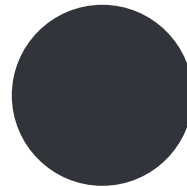

Granite\* - SMC

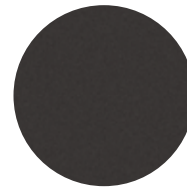

Umbra\* - SMC

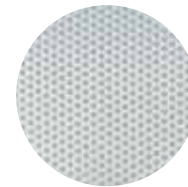

Aluminium medial - 5TD

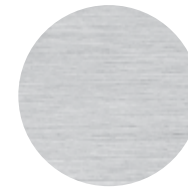

Matt-brushed aluminium - 5TG

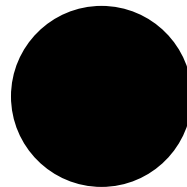

Piano finish, black - 5TL



Vavona wood, bernstein - 5ME



Burr walnut wood, dark brown - 5MP

Options are subject to availability and may extend delivery.

— = Not available  
● = Available  
S = Standard

\*Black upholstery = Granite inlays.  
Light grey/Luxor beige upholstery = Umbra inlays.

RRP - Recommended Retail Price.

VAT is calculated at 20% but this may alter to reflect any change in the applicable VAT rate.

# Inlays

## Audi exclusive

Audi exclusive has sourced a wide range of materials which you can select for your inlays, from Sepia oak to Fine grain myrtle.

Order Code		Standard	Sport	S line	Basic RRP	Total RRP inc VAT
YTA S3G	Audi exclusive inlays (cannot be combined with the inlays shown on page 30)	●	●	●	£650.00	£780.00



Fine grain ash, nougat



Fine grain myrtle, nutmeg

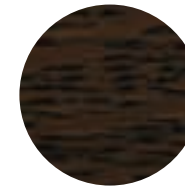

Oak, sepia

Options are subject to availability and may extend delivery.

- = Not available
- = Available
- S = Standard

RRP - Recommended Retail Price.

VAT is calculated at 20% but this may alter to reflect any change in the applicable VAT rate.

# Wheels and tyres

Choose a set of specially-selected alloy wheels to subtly enhance the way your car looks.

Order Code		Standard	Sport	S line	Basic RRP	Total RRP inc VAT
C4F	17" x 7.5J '5-arm dynamic' design alloy wheels with 225/45 R17 tyres	●	—	—	£425.00	£510.00
		—	●	—	£254.17	£305.00
C4N	17" x 7.5J '16-spoke' design alloy wheels with 225/45 R17 tyres	●	—	—	£466.67	£560.00
		—	●	—	£304.17	£365.00
C0X	17" x 7.5J '10-spoke V' design high gloss finish alloy wheels with 225/45 R17 tyres	●	—	—	£554.17	£665.00
		—	●	—	£383.33	£460.00
F41	18" x 7.5J '5-segment spoke' design alloy wheels with 225/40 R18 tyres	—	—	●	£295.83	£355.00
C2Q	18" x 7.5J '20-spoke' design alloy wheels with 225/40 R18 tyres	●	—	—	£1,054.17	£1,265.00
		—	●	—	£883.33	£1,060.00
		—	—	●	£295.83	£355.00



17" x 7.5J '5-arm dynamic' design alloy wheels – C4F



17" x 7.5J '10-spoke V' design high gloss finish alloy wheels – C0X



18" x 7.5J '5-segment spoke' design alloy wheels – F41

For more wheel images please contact your local Audi Centre

Options are subject to availability and may extend delivery.

— = Not available  
● = Available  
S = Standard

RRP – Recommended Retail Price.

VAT is calculated at 20% but this may alter to reflect any change in the applicable VAT rate.





# Packages

Some items work well together, which is why we've created these special packages. They provide increased convenience and value by combining several of our most popular options.

Order Code		Standard	Sport	S line	Basic RRP	Total RRP inc VAT
<b>WBI</b>	<b>Comfort package.</b> Acoustic parking system (rear only), cruise control and light and rain sensor package. Only in combination with Driver's Information System	●	●	●	£425.00	£510.00
<b>RSX</b>	<b>Sound package.</b> BOSE® premium sound system, Symphony radio and iPod connection. Not available in combination with technology package, Satellite Navigation system – DVD-based or CD-ROM based, AMI, CD changer or USB connection	●	–	–	£612.50	£735.00
<b>WB4</b>	<b>Technology package.</b> Satellite Navigation system – DVD-based, Bluetooth interface and Audi Music Interface. CD changer can be selected in lieu of AMI. Only in combination with a multi-function steering wheel. Not available in combination with sound package, iPod or USB connection	–	●	●	£1,270.83	£1,525.00

Options are subject to availability and may extend delivery.

- = Not available
- = Available
- S = Standard

RRP – Recommended Retail Price.

VAT is calculated at 20% but this may alter to reflect any change in the applicable VAT rate.





# Audio and communication

Stay in touch using our range of communication functions, and give each journey its own soundtrack with our advanced audio equipment.

Order Code		Standard	Sport	S line	Basic RRP	Total RRP inc VAT
<b>RCM</b>	<b>Concert radio.</b> AM/FM twin tuner with TP memo function. Single front-loading CD player with MP3 compatibility. Active front and rear speakers. Includes AUX-IN socket	●	S	S	£187.50	£225.00
<b>RSM</b>	<b>Symphony radio.</b> AM/FM twin tuner with TP memo function. Front-loading 6-CD changer and active front and rear speakers. Includes AUX-IN socket	● —	—	●	£412.50 £225.00	£495.00 £270.00
<b>8RY</b>	<b>BOSE® premium sound system.</b> 8 high-performance loudspeakers, 6-channel amplifier, total output of 222 Watts with specially tuned acoustics. Only in combination with Concert or Symphony radio	●	●	●	£375.00	£450.00
<b>PNX 7RF</b>	<b>Satellite Navigation system – CD-ROM based*.</b> Route-planning and guidance using voice and pictogram instructions. Includes AM/FM radio with TP memo function. Single front-loading CD player with MP3-compatibility. Includes AUX-IN socket, MMI operating logic and UK CD-ROM disc. Please note that this option does not include UK TMC functionality. Limited use of navigation system is possible when playing audio CDs, so a CD changer, USB or iPod connection is recommended with this option. Only in combination with electronic climate control and Driver's Information System	● —	—	●	£741.67 £554.17	£890.00 £655.00
<b>PND</b>	<b>Satellite Navigation system – DVD-based*.</b> Route planning and guidance using voice, pictogram and map. Includes AM/FM tuner with TP memo function. Single front-loading CD player with MP3 compatibility. Includes AUX-IN socket, MMI operating logic and 6.5-inch colour monitor with bird's-eye map display. Two integrated MMC/SD card slots for playing MP3 files, European coverage navigation DVD and dynamic route guidance via TMC. Limited use of navigation system is possible when playing audio CDs, so a CD changer or AMI is recommended with this option. Includes Driver's Information System. Only in combination with electronic climate control. (Audio or MP3 CDs cannot be used at the same time as navigation system)	● —	—	●	£1,591.67 £1,404.17	£1,910.00 £1,685.00
<b>9ZX</b>	<b>Mobile telephone preparation – Bluetooth interface.</b> Provides handsfree connection via Bluetooth using mobile phone aerial. Please contact your Audi Centre for phone compatibility. Does not include voice control. Only in combination with multi-function steering wheel and Driver's Information System	●	●	●	£208.33	£250.00
<b>9ZF</b>	<b>Mobile telephone preparation – Low with Bluetooth and located on dashboard.</b> Provides handsfree connection via Bluetooth using mobile phone aerial. Alternatively, it can use a cradle with charging facility for optimal reception via external aerial. Cradle available at extra cost – please contact your Audi Centre for phone compatibility. Does not include voice control. Only in combination with a multi-function steering wheel and Driver's Information System	●	●	—	£329.17	£395.00
<b>9ZU</b>	<b>Mobile telephone preparation – Low with Bluetooth and located in front centre armrest.</b> Provides handsfree connection via Bluetooth using mobile phone aerial. Alternatively, it can use a cradle with charging facility for optimal reception via external aerial. Cradle available at extra cost – please contact your Audi Centre for phone compatibility. Does not include voice control. Only in combination with a multi-function steering wheel, front centre armrest and Driver's Information System	●	●	●	£329.17	£395.00

Options are subject to availability and may extend delivery.

— = Not available  
● = Available  
S = Standard

\*Uses 5 digit postcode recognition.

RRP – Recommended Retail Price.

VAT is calculated at 20% but this may alter to reflect any change in the applicable VAT rate.

# Audio and communication

Order Code		Standard	Sport	S line	Basic RRP	Total RRP inc VAT
UF7	<b>Audi Music Interface (AMI).</b> Universal connection for use with stereo audio sources, USB and MP3 devices including Apple iPod generation 4 onwards (iPod, iPod classic, iPod mini, iPod nano, iPod photo, iPod video, iPod touch). Provides intuitive control through the audio system and multi-function steering wheel. It also replicates the iPod display on the audio screen and Driver's Information System (DIS), where fitted, including track titles. The interface provides charging function (dependent on device). Only in combination with Satellite Navigation system – DVD-based. Not available in combination with CD changer, iPod or USB connection	●	●	●	£212.50	£255.00
UF1	<b>iPod connection.</b> For playing/charging your iPod. Located in glovebox and controllable via radio or multi-function steering wheel (if fitted). Cannot be combined with AMI, CD changer or USB connection. Not available in combination with Satellite Navigation system – DVD-based	●	●	●	£154.17	£185.00
UF2	<b>USB connection.</b> For playing music from your USB stick. Located in glovebox and controlled via radio or multi-function steering wheel (if fitted). Cannot be combined with AMI, CD changer or iPod connection. Not available in combination with Satellite Navigation System – DVD-based	●	●	●	£154.17	£185.00
7A2	<b>CD changer.</b> For 6 CDs, located in glovebox and controllable via radio or multi-function steering wheel (if fitted). Cannot be combined with Symphony radio, AMI, iPod or USB connection	●	●	●	£270.83	£325.00
PI1	<b>Driver's Information System (DIS) – monochrome.</b> AutoCheck system, radio frequency, two adjustable speed warning thresholds, outside temperature gauge and on-board computer	●	S	S	£170.83	£205.00

Options are subject to availability and may extend delivery.

– = Not available  
● = Available  
S = Standard

RRP – Recommended Retail Price.

VAT is calculated at 20% but this may alter to reflect any change in the applicable VAT rate.



BOSE® premium sound system



Satellite Navigation system – DVD-based



iPod connection



AUX-IN socket in front centre compartment

# Seats

Choose from a variety of different seat options so you can maintain the right driving posture at all times.

Order Code		Standard	Sport	S line	Basic RRP	Total RRP inc VAT
4A3	<b>Heated front seats.</b> Individually controlled variable temperature adjustment	●	●	●	£212.50	£255.00
4A4	<b>Heated front and rear seats.</b> Individually controlled variable temperature adjustment	●	●	●	£383.33	£460.00
7P1	<b>Electric lumbar support.</b> For front seats with horizontal and vertical adjustment	●	●	●	£162.50	£195.00

Options are subject to availability and may extend delivery.

- = Not available
- = Available
- S = Standard

RRP – Recommended Retail Price.

VAT is calculated at 20% but this may alter to reflect any change in the applicable VAT rate.



# Safety and security

Intelligent technology designed to give you better all-round awareness and safety on the road.

Options are subject to availability and may extend delivery.

- = Not available  
 • = Available  
 S = Standard

RRP – Recommended Retail Price.

VAT is calculated at 20% but this may alter to reflect any change in the applicable VAT rate.

Order Code		Standard	Sport	S line	Basic RRP	Total RRP inc VAT
7X1	<b>Acoustic parking system (rear only).</b> Aids parking by acoustically indicating distances to obstacles	•	•	•	£254.17	£305.00
7X2	<b>Acoustic parking system (front and rear).</b> Aids parking by acoustically indicating distances to obstacles. Also includes visual display in combination with Satellite Navigation system – DVD-based (where fitted)	•	•	•	£445.83	£535.00
	In combination with Comfort package	•	•	•	£191.67	£230.00
7X5 UG1	<b>Parallel park assist.</b> Sensor-controlled steering aid to assist parallel parking with parking sensors (front and rear) acoustically indicating distances to obstacles. Includes Audi hill-hold assist. Only in combination with Driver's Information System	•	•	•	£616.67	£740.00
	In combination with Comfort package	•	•	•	£362.50	£435.00
UG4	<b>Audi hill-hold assist.</b> Prevents roll-back on hills for up to 5 seconds by maintaining brake force. Standard on S tronic	•	•	•	£66.67	£80.00
6XE	<b>Door mirrors – electrically folding</b>	•	•	•	£104.17	£125.00
1T3	<b>First-aid kit.</b> In storage compartment under front passenger seat	•	•	•	£20.83	£25.00
8WB	<b>Front fog lights</b> with chrome surrounds	•	S	S	£116.67	£140.00
7K6	<b>Tyre pressure loss indicator.</b> A visual and acoustic warning is given when the system detects a loss of pressure in an individual tyre. Only in combination with Driver's Information System	•	•	•	£62.50	£75.00



Front fog lights with chrome surrounds

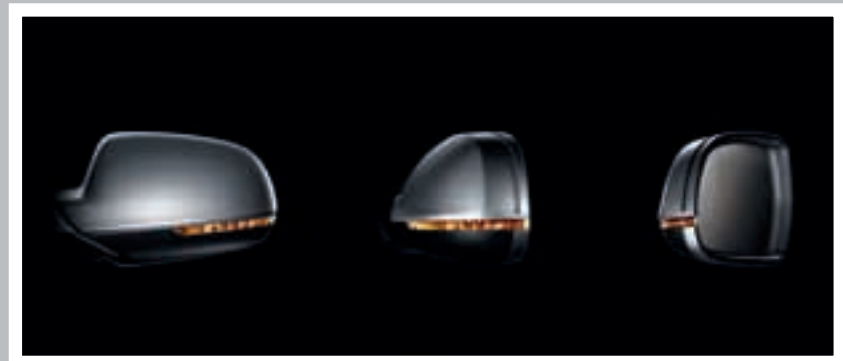

Electrically adjustable door mirrors with integrated indicators

# Steering wheels

You can choose a multi-function steering wheel to allow you to control your audio system at the touch of a button.

Order Code		Standard	Sport	S line	Basic RRP	Total RRP inc VAT
2ZQ	<b>4-spoke multi-function steering wheel.</b> Manual models only – includes Driver's Information System	●	–	–	£304.17	£365.00
2ZS	<b>4-spoke multi-function steering wheel with gear-shift paddles.</b> S tronic models only – includes Driver's Information System	●	–	–	£233.33	£280.00
6Q6	<b>Aluminium gear knob.</b> Manual models only	●	●	●	£83.33	£100.00

– = Not available

● = Available

S = Standard

RRP – Recommended Retail Price.

VAT is calculated at 20% but this may alter to reflect any change in the applicable VAT rate.







# Interior equipment

Specify every detail of your car's interior with this range of exclusive options.

Options are subject to availability and may extend delivery.

- = Not available  
• = Available  
S = Standard

\*Leather and stitching (where applicable) can be specified in a variety of Audi exclusive colours shown on page 28.

RRP – Recommended Retail Price.

VAT is calculated at 20% but this may alter to reflect any change in the applicable VAT rate.

Order Code		Standard	Sport	S line	Basic RRP	Total RRP inc VAT
8T2	<b>Cruise control.</b> For holding any speed above 25mph. Only in combination with Driver's Information System	•	•	•	£183.33	£220.00
9AK	<b>Dual-zone electronic climate control.</b> Includes separate temperature controls and digital displays for driver and front passenger	•	S	S	£320.83	£385.00
6E3	<b>Front centre armrest with storage compartment</b>	•	S	S	£83.33	£100.00
QQ4	<b>Interior light package.</b> Includes illuminated door openers, storage compartment, footwell lighting and active door reflectors	•	•	•	£75.00	£90.00
PU7 6XJ	<b>Light and rain sensor package.</b> Includes auto-dimming rear-view mirror and door mirrors, automatic headlight activation, automatic windscreen wipers, coming home/leaving home function and sun band for windscreen	•	•	•	£275.00	£330.00
6SJ	<b>Reversible load floor mat.</b> Luggage compartment floor mat can be reversed to provide a rubber mat which extends to protect rear bumper	•	•	•	£41.67	£50.00
PKC	<b>Storage package.</b> Comprising storage nets on front-seat backrests, storage compartment under driver's seat, map compartment in glovebox, net on side of centre console, two bag hooks in luggage compartment, additional light and 12V socket in luggage compartment and load-securing net	•	•	•	£129.17	£155.00
7S1	<b>Wind deflector.</b> To reduce draughts and wind noise. Manually attached to mounting in rear seating area. Can be folded for compact stowage	•	S	S	£195.83	£235.00
9JA	<b>Non-smoking package.</b> Replaces ashtray and cigarette lighter with 12V socket and centre storage compartment	•	•	•	No charge	No charge
YRH S3G	<b>Audi exclusive leather-covered steering wheel rim*</b>	•	•	•	£304.17	£365.00
YRB S3G	<b>Audi exclusive controls package.*</b> Includes leather-covered steering wheel rim, handbrake grip and gear-shift gaiter	•	•	•	£512.50	£615.00



Dual-zone electronic climate control



Wind deflector



Front centre armrest

# Exterior equipment

Make sure your car looks exactly as you want it to by selecting some of our striking options.

Order Code		Standard	Sport	S line	Basic RRP	Total RRP inc VAT
8N7	<b>High-beam assist.</b> Automatically adjusts headlights from high-beam to dipped-beam when another vehicle is approaching. Only in combination with Driver's Information System and light and rain sensor package	●	●	●	£83.33	£100.00
PX4	<b>Xenon Plus headlights.</b> Includes LED daytime-running lights, automatic headlight adjustment, dynamic range control and headlight washers	—	—	●	£462.50	£555.00
PX4	<b>Adaptive headlights.</b> Swivelling headlights for improved illumination of a winding road. Includes Xenon Plus headlights with LED daytime-running lights and headlight washers	●	●	—	£850.00	£1,020.00
8Q5		—	—	●	£712.50	£855.00
4ZM 2Y1	<b>Black styling package.</b> Radiator grille-frame in highly polished black, with radiator grille, fog-light surrounds and number plate holder in matt black. Also includes door handles in body colour, black shoulder line trim and roll bars	●	●	●	£254.17	£305.00
2Z0	<b>Deletion of model and technology designation at rear</b>	●	●	●	No charge	No charge
1D2	<b>Towing equipment – removable.</b> Factory-fitted and removable. Includes single European 13-pin electric socket and may require a 13- to 7-pin adaptor. Please consult your Audi Centre for details*. Not available on 1.6 TDI S line model or 2.0 TDI 140PS S line models	●	●	●	£470.83	£565.00

Options are subject to availability and may extend delivery.

— = Not available  
● = Available  
S = Standard

\*Additional wiring is required for auxiliary equipment.

RRP – Recommended Retail Price.

VAT is calculated at 20% but this may alter to reflect any change in the applicable VAT rate.

# Audi Complete

Audi Complete is simply a way to look after the servicing and maintenance costs for your Audi in a single package. You pay a one-off or monthly fee and we'll cover all your servicing, maintenance and tyres for the next three years including your first MOT and a full 5-year warranty. It means you only have to pay for fuel, insurance and your Road Fund Licence. So you can be reassured that your car will be maintained by trained Audi Technicians, using genuine Audi parts.

\*Retail customers only. Pricing based on 3 years/30,000 miles (whichever occurs sooner). All pricing is a 'starting from' price for the Audi A3 Cabriolet model range and is therefore subject to change and mileage/model dependent

# Warranty

Options are subject to availability and may extend delivery.

- = Not available
- = Available
- S = Standard

\*\*Only available prior to registration of your A3 Cabriolet. Please speak to your Audi Centre for full details.

RRP – Recommended Retail Price.

VAT is calculated at 20% but this may alter to reflect any change in the applicable VAT rate.

Order Code		Payment	A3 Cabriolet	Basic RRP	Total RRP inc VAT
AC1	<b>Audi Complete – Service, Maintenance and 5-year warranty.</b> Comprehensive care for your Audi covering all your servicing and maintenance for 3 years, as well as your first MOT and a full 5-year/90,000 mile warranty. Visit your local Audi Centre for further information or <a href="http://audi.co.uk/audicomplete">audi.co.uk/audicomplete</a> for full details including terms and conditions	Monthly Direct Debit	•	£23.33	£28.00*
AC2	<b>Audi Complete – Service, Maintenance, Tyres and 5-year warranty.</b> Comprehensive care for your Audi covering all your servicing, maintenance and tyres for 3 years, as well as your first MOT and a full 5-year/90,000 mile warranty. Visit your local Audi Centre for further information or <a href="http://audi.co.uk/audicomplete">audi.co.uk/audicomplete</a> for full details including terms and conditions	Monthly Direct Debit	•	£30.00	£36.00*

Order Code		A3 Cabriolet	Basic RRP	Total RRP inc VAT
-	<b>Audi Warranty</b> , covering you for unlimited mileage in the first two years of ownership, and up to 60,000 miles in the third year. Transferable between owners**	S	No charge	No charge
EA6	<b>Audi Warranty</b> , covering you for up to 4 years or 75,000 miles, whichever comes soonest. Cover includes a two-year unlimited mileage warranty, and up to 75,000 miles in the third and fourth years. Transferable between owners**	•	£204.17	£245.00
EA9	<b>Audi Warranty</b> , covering you for up to 5 years or 90,000 miles, whichever comes soonest. Cover includes a two-year unlimited mileage warranty, and up to 90,000 miles in the third, fourth and fifth years. Transferable between owners**	•	£454.17	£545.00

# Merchandise

From the enthusiasts' motorsport collection to the sophisticated Audi collection, there's a wide variety of adults' and children's clothing, lifestyle accessories and collectables, all of which bear the Audi name.

Please speak to a member of our team at your local Audi Centre to see the full Audi collection and to place an order. A selection of Audi merchandise is also available to buy from [audi.co.uk/merchandise](http://audi.co.uk/merchandise).



Audi kids



Bags and leather goods



Clothing



Motorsports



Sport and travel



Model cars

# Accessories

Choosing an Audi isn't just a matter of deciding on the model you want; it's about creating a car that suits your needs perfectly. And that's why we've developed a whole range of accessories to enhance your A3 Cabriolet, enabling you to customise it down to the last detail. Like your Audi, all these accessories are developed to the highest possible standards. And they're all available exclusively from Audi.

To find out more, just visit [audi.co.uk/accessories](http://audi.co.uk/accessories) or contact your local Audi Centre.

## Warranty

All the accessories available on the A3 Cabriolet are covered by a three-year warranty\* if they are ordered and included in the purchase price of the car at date of delivery. Any accessories ordered and installed after delivery include a two-year warranty.\*



Sport and design



Transport and touring



Entertainment and communication



Comfort and protection

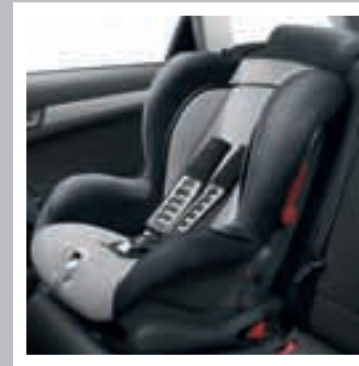

Family



Safety and security

\*Excluding Road Angel products.  
Audi Accessories warranty terms and conditions can be found at [audi.co.uk](http://audi.co.uk)

# A3 Cabriolet Petrol technical data

Engine	1.2 TFSI	1.8 TFSI	1.8 TFSI	2.0 TFSI	2.0 TFSI
Transmission	6-speed manual	6-speed manual	7-speed S tronic	6-speed manual	6-speed S tronic
Cylinder	4-cylinder	4-cylinder	4-cylinder	4-cylinder	4-cylinder
Displacement, cubic cm (valves per cylinder)	1197 (2)	1798 (4)	1798 (4)	1984 (4)	1984 (4)
Max. power <sup>1</sup> , PS at rpm	105/5000	160/5000-6200	160/5000-6200	200/5100-6000	200/5100-6000
Max. torque, Nm at rpm	175/1500-4100	250/1500-4200	250/1500-4200	280/1800-5000	280/1800-5000
0-62mph acceleration, seconds	12.2	8.2	8.0	7.4	7.3
Top speed <sup>2</sup> , mph	118	135	135	144	144
CO <sub>2</sub> emissions <sup>3</sup> , g/km	132	156	154	169	171
Benefit in kind (BIK)%	16%	21%	20%	23%	24%
Fuel consumption <sup>3</sup> , mpg (l/100km) Urban	40.4 (7.0)	31.7 (8.9)	32.5 (8.7)	28.2 (10.0)	28.5 (9.9)
Fuel consumption <sup>3</sup> , mpg (l/100km) Extra Urban	56.5 (5.0)	51.4 (5.5)	52.3 (5.4)	50.4 (5.6)	47.9 (5.9)
Fuel consumption <sup>3</sup> , mpg (l/100km) Combined	49.6 (5.7)	42.2 (6.7)	42.8 (6.6)	39.2 (7.2)	38.2 (7.4)
ABI insurance group 1-50*	18 E	28 E	28 E	31 E	31 E
Unladen weight <sup>4</sup> , kg	1360	1425	1450	1435	1485
Gross weight limit, kg	1860	1925	1950	1935	1985
Max trailer load unbraked <sup>5</sup> , kg	710	750	750	750	750
Max trailer load with 12% gradient <sup>5</sup> , kg	1200	1400	1400	1400	1400
Max trailer load with 8% gradient <sup>5</sup> , kg	1500	1700	1700	1700	1700
Luggage compartment capacity, rear seats upright, litres	260	260	260	260	260
Luggage compartment capacity, rear seats folded, litres	674	674	674	674	674
Fuel tank capacity approx, litres	55	55	55	55	55

\*Highest insurance group rating shown. Group may be lower dependent on trim level. Please visit [www.thatcham.org/abigroupratings](http://www.thatcham.org/abigroupratings) for details.

<sup>1</sup>The given value was obtained in accordance with the specified measurement procedure (the respective current version of the Directive 80/1269/EEC).

<sup>2</sup>Top speed is achieved in top gear.

<sup>3</sup>Fuel consumption and CO<sub>2</sub> emissions figures are obtained under standardised test conditions (Directive 93/116/EEC) using a representative model. This allows direct comparison between different models from different manufacturers, but may not represent the actual fuel consumption achieved in 'real world' driving conditions. More information is available at [www.vca.gov.uk](http://www.vca.gov.uk).

<sup>4</sup>Vehicle's unladen weight without driver (calculated in accordance with the current version of Directive 80/1268/EEC). The fitting of additional equipment may increase the vehicle's unladen weight and drag coefficient, whereupon the potential carrying capacity and top speed will be correspondingly reduced.

<sup>5</sup>The engine's power output always goes down with increasing altitude. At 1,000m above sea level, and for every additional 1,000m, deduct 10% from the weight of the outfit (trailer load limit + gross weight of the towing vehicle).

**Please note:** The maximum power output figures are quoted in PS (or Pferdestärke, which is the metric equivalent of brake horsepower). To convert to horsepower, divide the PS figure by 1.0139

# A3 Cabriolet Diesel technical data

Engine	1.6 TDI	2.0 TDI	2.0 TDI
Transmission	5-speed manual	6-speed manual	6-speed S tronic
Cylinder	4-cylinder	4-cylinder	4-cylinder
Displacement, cubic cm (valves per cylinder)	1598 (4)	1968 (4)	1968 (4)
Max. power <sup>1</sup> , PS at rpm	105/4400	140/4200	140/4200
Max. torque, Nm at rpm	250/1500-2500	320/1750-2500	320/1750-2500
0-62mph acceleration, seconds	12.2	9.6	9.4
Top speed <sup>2</sup> , mph	118	129	129
CO <sub>2</sub> emissions <sup>3</sup> , g/km	114	119	134
Benefit in kind (BIK)%	13%	13%	19%
Fuel consumption <sup>3</sup> , mpg (l/100km) Urban	54.3 (5.2)	49.6 (5.7)	47.1 (6.0)
Fuel consumption <sup>3</sup> , mpg (l/100km) Extra Urban	72.4 (3.9)	72.4 (3.9)	61.4 (4.6)
Fuel consumption <sup>3</sup> , mpg (l/100km) Combined	65.7 (4.3)	61.4 (4.6)	55.4 (5.1)
ABI insurance group 1-50*	21 E	26 E	26 E
Unladen weight <sup>4</sup> , kg	1430	1475	1495
Gross weight limit, kg	1930	1975	1995
Max trailer load unbraked <sup>5</sup> , kg	750	750	750
Max trailer load with 12% gradient <sup>5</sup> , kg	1400	1400	1400
Max trailer load with 8% gradient <sup>5</sup> , kg	1700	1700	1700
Luggage compartment capacity, rear seats upright, litres	260	260	260
Luggage compartment capacity, rear seats folded, litres	674	674	674
Fuel tank capacity approx, litres	55	55	55

\*Highest insurance group rating shown. Group may be lower dependent on trim level. Please visit [www.thatcham.org/abigroupratings](http://www.thatcham.org/abigroupratings) for details.

<sup>1</sup>The given value was obtained in accordance with the specified measurement procedure (the respective current version of the Directive 80/1269/EEC).

<sup>2</sup>Top speed is achieved in top gear.

<sup>3</sup>Fuel consumption and CO<sub>2</sub> emissions figures are obtained under standardised test conditions (Directive 93/116/EEC) using a representative model. This allows direct comparison between different models from different manufacturers, but may not represent the actual fuel consumption achieved in 'real world' driving conditions. More information is available at [www.vca.gov.uk](http://www.vca.gov.uk).

<sup>4</sup>Vehicle's unladen weight without driver (calculated in accordance with the current version of Directive 80/1268/EEC). The fitting of additional equipment may increase the vehicle's unladen weight and drag coefficient, whereupon the potential carrying capacity and top speed will be correspondingly reduced.

<sup>5</sup>The engine's power output always goes down with increasing altitude. At 1,000m above sea level, and for every additional 1,000m, deduct 10% from the weight of the outfit (trailer load limit + gross weight of the towing vehicle).

**Please note:** The maximum power output figures are quoted in PS (or Pferdestärke, which is the metric equivalent of brake horsepower). To convert to horsepower, divide the PS figure by 1.0139

## A3 Cabriolet dimensions

The technical drawings opposite show the exact dimensions of the A3 Cabriolet, so you can check everything – from whether the car will fit in your garage to whether your luggage will fit in the boot.

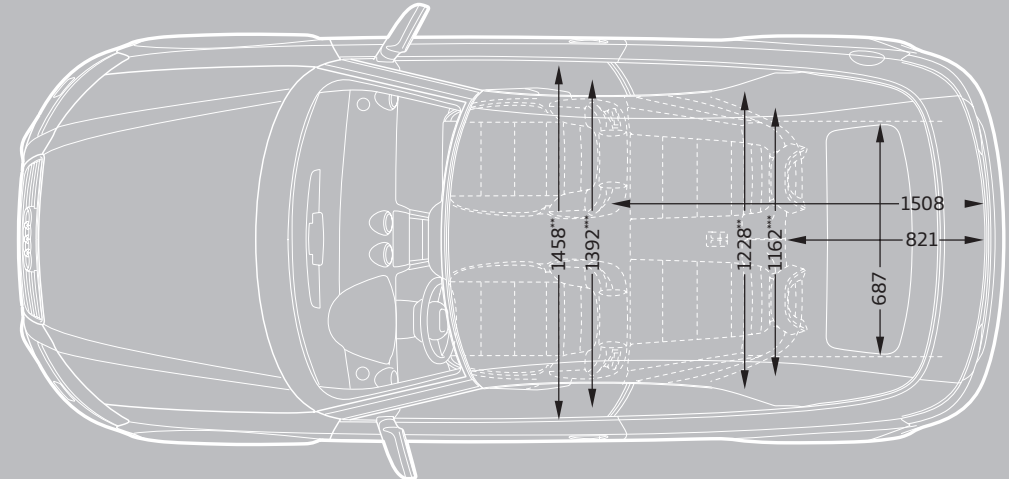
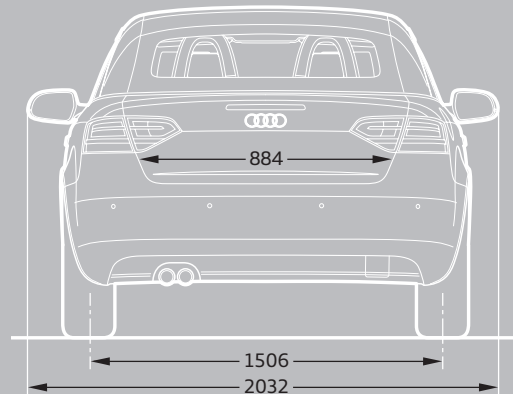
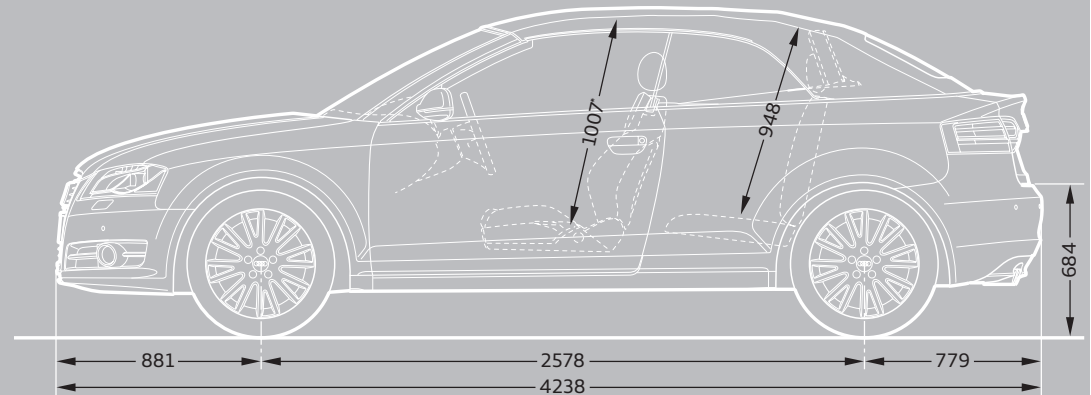
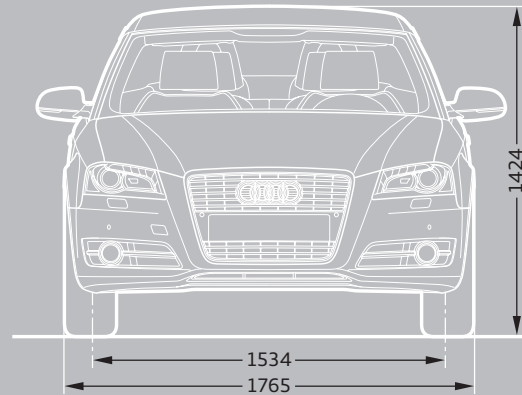

Dimensions were measured with vehicle at unladen weight.

Luggage compartment volume in litres: 260/260 (as measured by the VDA standard test method using 200 x 100 x 50mm blocks; first value: closed hood; second value: open hood).

Turning circle approx 10.7m.  
Dimensions in millimetres.  
\*Maximum headroom.



# Additional information

## CO2 data and information

### CO2 emissions-based Vehicle Excise Duty

Vehicle Excise Duty (Road Fund Licence) is based upon the amount of Carbon Dioxide (CO2) a vehicle emits, measured in grams per kilometre (g/km). First year VED rates apply to the first year of ownership. Annual VED rates apply thereafter. The DVLA has created thirteen categories:

Petrol and Diesel engines	First year	Annual rate (second year onwards)
A – up to 100g/km	£0.00	£0.00
B – 101 to 110g/km	£0.00	£20.00
C – 111 to 120g/km	£0.00	£30.00
D – 121 to 130g/km	£0.00	£95.00
E – 131 to 140g/km	£115.00	£115.00
F – 141 to 150g/km	£130.00	£130.00
G – 151 to 165g/km	£165.00	£165.00
H – 166 to 175g/km	£265.00	£190.00
I – 176 to 185g/km	£315.00	£210.00
J – 186 to 200g/km	£445.00	£245.00
K – 201 to 225g/km	£580.00	£260.00
L – 226 to 255g/km	£790.00	£445.00
M – over 255g/km	£1,000.00	£460.00

Vehicle Excise Duty (VED) rates correct at time of going to print, but these may alter to reflect any change in the applicable VED rate

### Servicing tailored to your needs

Regular servicing is key to safeguarding your Audi's performance and a full Audi service history could help you preserve the future re-sale value. To make servicing easy, the Audi Service Schedules have been designed to work with your individual driving style and vehicle.

There are two schedules available and your Audi Centre will advise which schedule is most suited to your needs. The conventional fixed Audi Inspection Service Schedule has fixed intervals for the Oil-change and Inspection Service that are based on time and distance, whichever comes first.

With the Audi LongLife Service Schedule, sensors take account of driving style and conditions in which the vehicle is used to indicate when the Oil-change Service is required. Oil-change Service intervals are therefore variable and are conveniently indicated via the on-board service interval display.

### Audi Complete

When selecting the option of Audi Complete your vehicle should be placed on the following service schedules dependent on your mileage per annum:

- ▶ Under 10,000 miles per annum – Fixed Inspection Service Schedule
- ▶ Over 10,000 miles per annum – LongLife Service Schedule

Fixed Inspection Service Schedule		Variable LongLife Service Schedule	
	<b>Vehicle usage:</b>		<b>Vehicle usage:</b>
Mileage	Less than 10,000 miles per annum	Mileage	More than 10,000 miles per annum
Type of journey	Mainly city/town centre driving. Short journeys	Type of journey	Motorway and main road driving. Mainly longer distance journeys. Constant speeds
Conditions	Frequent cold starts. High engine loading – e.g. frequent hill climbs, vehicle fully loaded, towing	Conditions	Normal engine loading – e.g. with little or no towing, with little or no hill climbs. Normal vehicle loading
Driving style	Uneconomical – e.g. heavy acceleration, heavy braking, constant changes in speed, constant use of high revs, 'sporty' driving	Driving style	Moderate acceleration, moderate braking, engine revs mainly below 3,000
	<b>Service Intervals:</b>		<b>Service Intervals:</b>
Oil-change Service	Fixed to every 9,000* miles/1 year	Oil-change Service	Variable to a maximum of every 19,000* miles/2 years
Inspection Service	Fixed to every 19,000* miles/2 years	Inspection Service	Fixed to every 19,000* miles/2 years

\*As indicated by the service interval display. Mileages are approximate as the Service Indicator system uses kilometres as its distance measurement.

# Additional information

## Welcome to Audi

By placing an order for your Audi, you're choosing to get behind the wheel of one of the most sophisticated cars on the road. And because we believe the service we offer should be just as advanced, we wanted to let you know exactly what you can expect from us, now and in the future.

We've agreed a set of standards with all our Centres, which governs the way we do business with you. It outlines the kind of service we promise to deliver for every customer, right down to filling each new Audi we sell with half a tank of fuel.

So whether you're interested in the date your car will arrive in the UK or the way we'll dispose of non-biodegradable materials after we service your Audi, you can have total confidence in us.

## Audi Promise

### Audi Centres

We guarantee that all our Centres will be open as follows:

Sales: Monday to Friday 9am–6pm  
Saturday 9am–5pm

Service: Monday to Friday 8am–6pm  
Saturday 8.30am–1pm

Sunday opening is at local discretion.

### New car delivery

Once we've confirmed a delivery date for your car, we'll keep you informed of progress. Subject to reasonable notice, we'll then deliver it to a place of your choice, whether that's your home or work. In the unlikely event of a delay, we'll provide a courtesy car to minimise inconvenience and keep you mobile.

### The experts in Vorsprung durch Technik

Would you entrust your Audi to anyone who hasn't been regularly trained to Audi standards? Our Audi Approved Master Technicians have undergone an impressive 100,000 hours of training over a 10-year programme to ensure they have the latest technical expertise for maintaining and servicing your Audi. All our Service Advisors undergo a specialist induction and training to ensure they are Audi professionals and able to talk to you about any issues you may have with your Audi vehicle. What's more, we have so much expertise and experience in looking after Audi vehicles that we are able to make a note of your mileage and the state of your vehicle as and when we see it and predict when certain key events may occur. As part of our commitment to you, we will notify you in plenty of time so you can make an appointment with us.

### Your convenience comes first

At Audi you can choose from a range of convenient services that suit your needs. Why not book a 'service while you wait' appointment\* and enjoy our complimentary refreshments while your car is with us? Or, if you need to be mobile, take advantage of one of our courtesy cars which we can even collect and deliver to you.\* We guarantee we can service your Audi within 5 days without a courtesy car, or within 10 days if you need transport. We will also ensure your car is returned to you with a full valet.

### Audi Genuine Parts

Would you put a part into your Audi that wasn't the same quality as the factory fitted original? You can rest assured that only Audi Genuine Parts will be used on your vehicle. What's more, Audi parts and labour come with a 2-year guarantee.\*\* We stock a wide variety of parts, so we are well covered. However, if we don't have a part in stock at our Centre we have the back-up of parts at other Audi Centres, at our national warehouse and our factory and can usually source the relevant part very quickly.

### We don't like surprises either

We believe strongly in transparency and there will be no hidden costs. For added peace of mind, we will give you a quotation over the phone for the work you have requested and email you the price confirmation. We'll consult you if any additional work on your car is needed when it is with us. We won't carry out any extra work without asking your permission first.

### The Audi Stamp

Regular servicing is key to safeguarding your Audi's performance and a full Audi service history could help you preserve the future re-sale value of your car. Only the Audi Stamp will prove your approved Audi service history.

### Getting better every time

We continually gather feedback from our Audi Trained Technicians, as well as our customers, to ensure our vehicles are running as they should. Whenever we see an Audi for a service, we connect it directly to our headquarters in Ingolstadt which enables us to check your car's software and make sure it's as up-to-date as possible. If the factory has released a software upgrade for your model, it can be applied immediately – improving anything from your car's efficiency to the precision of its parking system.

### Environmental commitment

We promise to dispose of all non-biodegradable materials from your vehicle in a responsible manner

\*Subject to availability.

\*\*Excludes wear and tear.

# Pricing information

## Pricing

Prices and specifications given are correct at the time of printing. Always check details with your Audi Centre, as Audi policies are continually developing. We reserve the right to change prices or specifications at any time.

All prices are subject to VAT, currently charged at 20% but this may alter to reflect any change in the applicable VAT rate.

Delivery charges and number plates are not included in the vehicle price.

Delivery charge	£471.66
Number plate	£20.00
VAT	£98.34
Total	£590.00

## Audi Roadside Assistance

Your new car comes complete with 3 years' complimentary roadside assistance and recovery across the UK provided by RAC Motoring Services. Also included is roadside assistance throughout Europe, managed by RAC Motoring Services.

For further information and terms and conditions please visit [audi.co.uk](http://audi.co.uk)

## Audi Customer Care

Every new Audi benefits from the comprehensive Audi Customer Care Package, which comprises:

- ▶ A three-year Audi warranty, which covers you for unlimited mileage in the first two years of ownership, with a full mechanical and electrical warranty which covers you for up to 60,000 miles in the third year

- ▶ A 3-year paint warranty
- ▶ A 12-year anti-corrosion warranty
- ▶ 3 years' UK roadside assistance and recovery

You also have the option when ordering your new car of choosing a 4-year or 5-year Audi warranty. Speak to a member of the sales team for more information.

## Audi Tax-Free Sales

If you are entitled to purchase a vehicle free of VAT, normally through Military or Diplomatic privilege, please contact your local Audi Centre for full details.

Should you have any difficulty obtaining the information you require, please call Freephone 0800 585878.

## Audi Finance

Audi Finance specialise in providing funding solutions for Audi drivers. Whether your Audi is for private or business use, there are a range of funding options to choose from.

Below is the full range of finance products.

- ▶ Solutions – a Personal Contract Plan
- ▶ Hire purchase
- ▶ Lease purchase
- ▶ Finance lease
- ▶ Contract hire

With all products, you can choose a fixed-cost maintenance plan designed to help you budget accurately.

No matter what Audi model you choose, your local Audi Centre can provide you with a personalised quote which could fit your budget and motoring needs.

Audi Finance is a trading name of Volkswagen Financial Services (UK) Limited. An offer of finance depends on certain conditions. Available to people over 18 in the UK only.

## Audi Insurance

We want you to start enjoying your new car from day one and thanks to Audi Insurance complimentary seven day cover, you can.

Call free on 0800 316 7893 (lines are open Monday to Friday 8am - 9pm, and Saturday 9am - 5pm), provide a few details and a cover note will be sent to your Audi Centre. They will then tax your car and you can drive it away.

Audi Insurance is a trading name of Volkswagen Insurance Service (Great Britain) Limited, an appointed representative of Volkswagen Financial Services (UK) Limited, Brunswick Court, Yeomans Drive, Blakelands, Milton Keynes MK14 5LR. Registered in England number 2835230. Audi Insurance is sold, underwritten and administered by Allianz Insurance plc registered in England number 84638. Registered office 57 Ladymead, Guildford, Surrey GU1 1DB. Volkswagen Financial Services (UK) Limited and Allianz Insurance plc are authorised and regulated by the Financial Services Authority. Volkswagen Financial Services (UK) Limited and Allianz Insurance plc are not part of the same corporate group.

**Audi UK**

Customer Services  
Selectapost 29  
Sheffield  
S97 3FG  
0800 699888  
[www.audi.co.uk](http://www.audi.co.uk)

Specifications and prices subject  
to change without notice.

© Audi UK

Printed in the UK  
Edition 6.0 10/11  
2012 model year

Images are for illustrative purposes.